

Features

- Voltage Controlled Small Signal Switch
- ESD Protected Up To 2KV (HBM)
- Moisture Sensitivity Level 1
- Halogen Free. "Green" Device (Note1)
- Epoxy Meets UL 94 V-0 Flammability Rating
- Lead Free Finish/RoHS Compliant ("P" Suffix Designates RoHS Compliant. See Ordering Information)

Maximum Ratings

- Operating Junction Temperature Range: -55°C to +150°C
- Storage Temperature: -55°C to +150°C
- Thermal Resistance: 150°C/W Junction to Ambient (Note2)

Parameter	Symbol	Rating	Unit
Drain-Source Voltage	V_{DS}	60	V
Gate-Source Voltage	V_{GS}	±20	V
Continuous Drain Current	I_D	$T_A=25^\circ\text{C}$	0.34
		$T_A=100^\circ\text{C}$	0.22
Pulsed Drain Current (Note3)	I_{DM}	1.36	A
Total Power Dissipation (Note4)	P_D	0.83	W

Note:

1. Halogen free "Green" products are defined as those which contain <900ppm bromine, <900ppm chlorine (<1500ppm total Br + Cl) and <1000ppm antimony compounds.
2. The value of $R_{\theta JA}$ is measured with the device mounted on 1in² FR-4 board with 2oz. Copper, in a still air environment with $T_A=25^\circ\text{C}$.
3. Repetitive rating; pulse width limited by max. junction temperature.
4. P_D is based on max. junction temperature, using junction-ambient thermal resistance.

Internal Structure and Marking Code

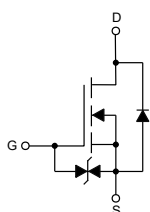

1. GATE
2. SOURCE
3. DRAIN

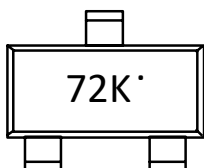

N-Channel MOSFET

SOT-23

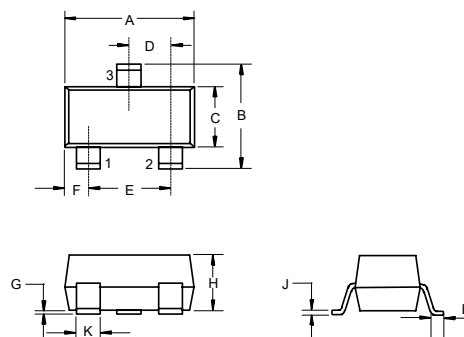

DIM	INCHES		MM		NOTE
	MIN	MAX	MIN	MAX	
A	0.110	0.120	2.80	3.04	
B	0.083	0.104	2.10	2.64	
C	0.047	0.055	1.20	1.40	
D	0.034	0.041	0.85	1.05	
E	0.067	0.083	1.70	2.10	
F	0.018	0.024	0.45	0.60	
G	0.0004	0.006	0.01	0.15	
H	0.035	0.043	0.90	1.10	
J	0.003	0.007	0.08	0.18	
K	0.012	0.020	0.30	0.51	
L	0.007	0.020	0.20	0.50	

Suggested Solder Pad Layout

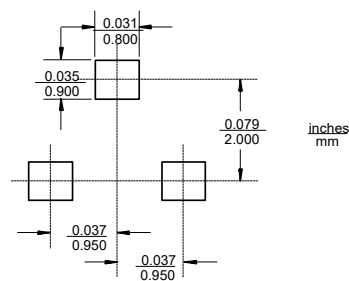

Electrical Characteristics @ 25°C (Unless Otherwise Specified)

Parameter	Symbol	Test Conditions	Min	Typ	Max	Unit
Static Characteristics						
Drain-Source Breakdown Voltage	$V_{(BR)DSS}$	$V_{GS}=0V, I_D=250\mu A$	60			V
Gate-Source Leakage Current	I_{GSS}	$V_{DS}=0V, V_{GS}=\pm 20V$			± 10	μA
		$V_{DS}=0V, V_{GS}=\pm 10V$			± 200	nA
		$V_{DS}=0V, V_{GS}=\pm 5V$			± 100	nA
Zero Gate Voltage Drain Current	I_{DSS}	$V_{DS}=48V, V_{GS}=0V$			1	μA
Gate-Threshold Voltage	$V_{GS(th)}$	$V_{DS}=V_{GS}, I_D=250\mu A$	1.0	1.3	2.5	V
Drain-Source On-Resistance	$R_{DS(on)}$	$V_{GS}=10V, I_D=500mA$		1.7	2.5	Ω
		$V_{GS}=4.5V, I_D=200mA$		2.1	3.0	
Forward Transconductance	g_{fs}	$V_{DS}=5V, I_D=0.5A$		0.4		S
Gate Resistance	R_g	f=1 MHz, Open drain		280		Ω
Diode Characteristics						
Continuous Body Diode Current	I_S				0.34	A
Diode Forward Voltage	V_{SD}	$V_{GS}=0V, I_S=300mA$			1.2	V
Reverse Recovery Time	t_{rr}	$I_F=0.3A, dI_F/dt=100A/\mu s$		9		ns
Reverse Recovery Charge	Q_{rr}			2.8		nC
Dynamic Characteristics						
Input Capacitance	C_{iss}	$V_{DS}=25V, V_{GS}=0V, f=1MHz$		15		μF
Output Capacitance	C_{oss}			3.6		
Reverse Transfer Capacitance	C_{rss}			2.2		
Total Gate Charge	Q_g	$V_{DS}=10V, V_{GS}=4.5V, I_D=0.2A$		0.38		nC
Gate-Source Charge	Q_{gs}			0.16		
Gate-Drain Charge	Q_{gd}			0.1		
Turn-On Delay Time	$t_{d(on)}$	$V_{DD}=50V, V_{GS}=10V, R_{GEN}=50\Omega, I_{DS}=0.17A$		4.5		ns
Turn-On Rise Time	t_r			4.3		
Turn-Off Delay Time	$t_{d(off)}$			14		
Turn-Off Fall Time	t_f			28		

Curve Characteristics

Fig. 1 - Typical Output Characteristics

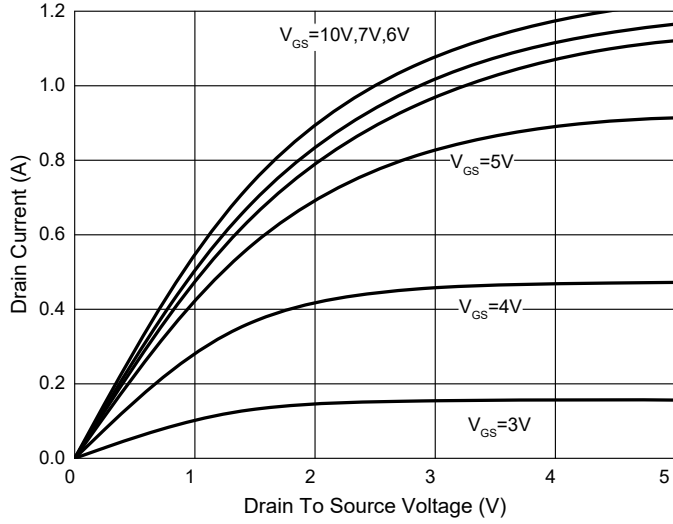

Fig. 2 - Transfer Characteristics

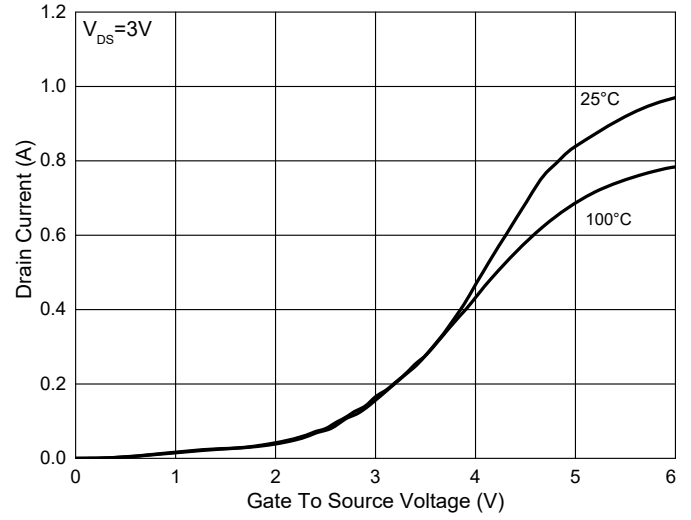

Fig.3 -Rdson-Vgs

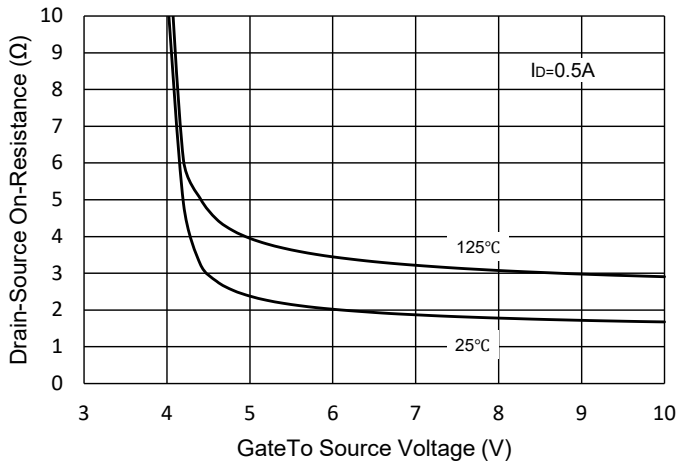

Fig.4 -RDS(ON)-ID

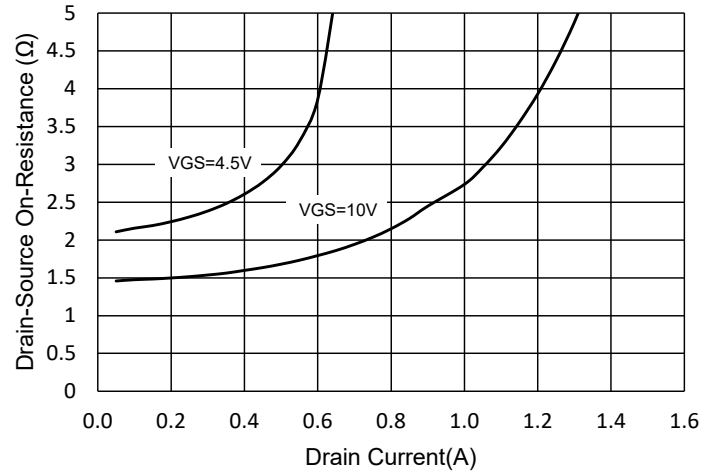

Fig.5- Capacitance Characteristics

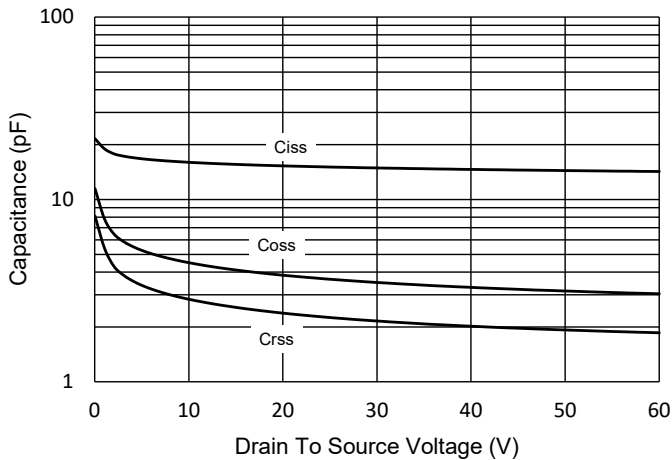
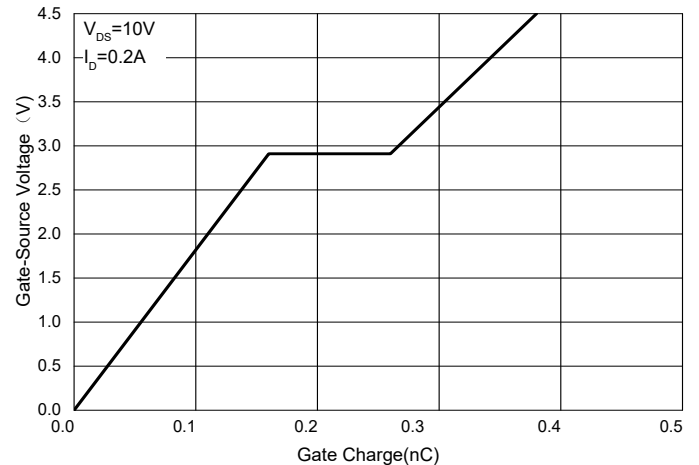

Fig. 6 - Gate Charge



Curve Characteristics

Fig.7- Normalized Threshold Voltage

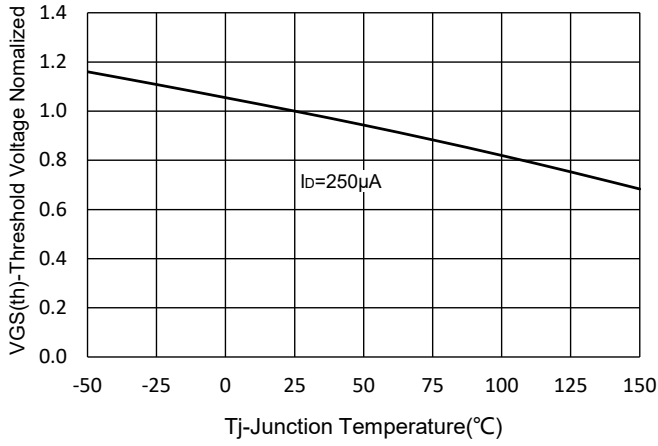

Fig.8- Normalized On Resistance Characteristics

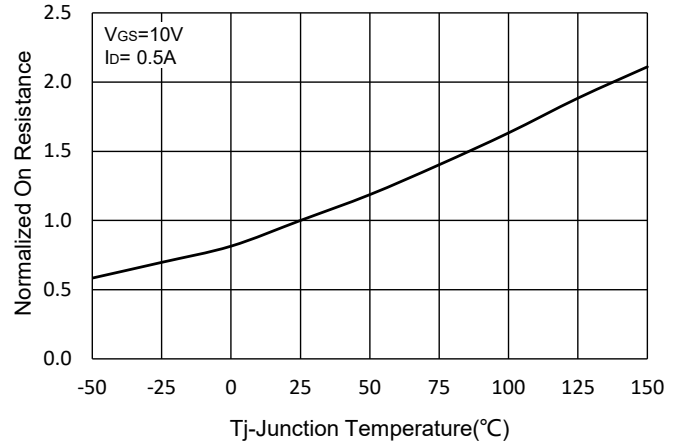

Fig.9- IS-VSD

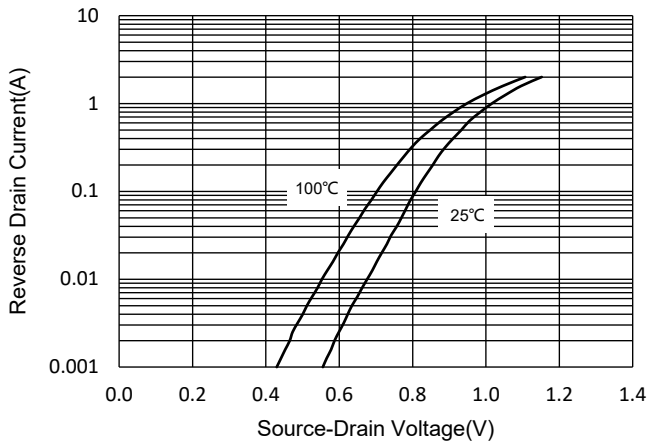

Fig. 10 - Drain Current

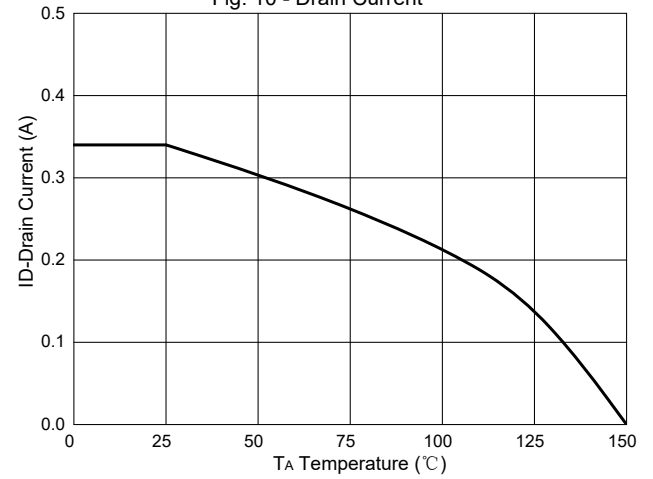
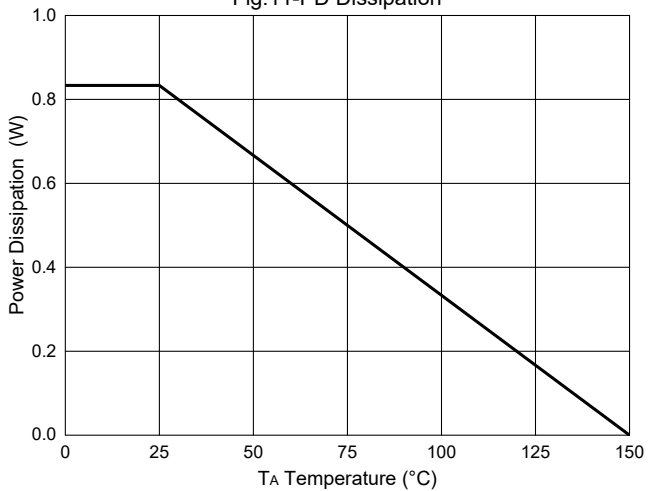

Fig.11-PD Dissipation



Curve Characteristics

Fig. 12 - Safe Operation Area

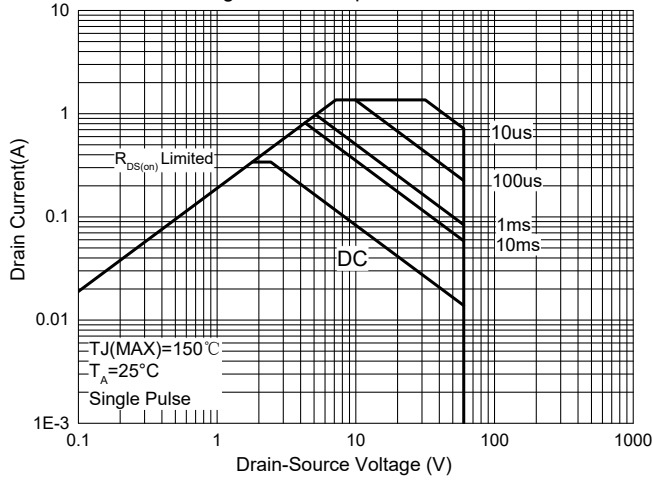
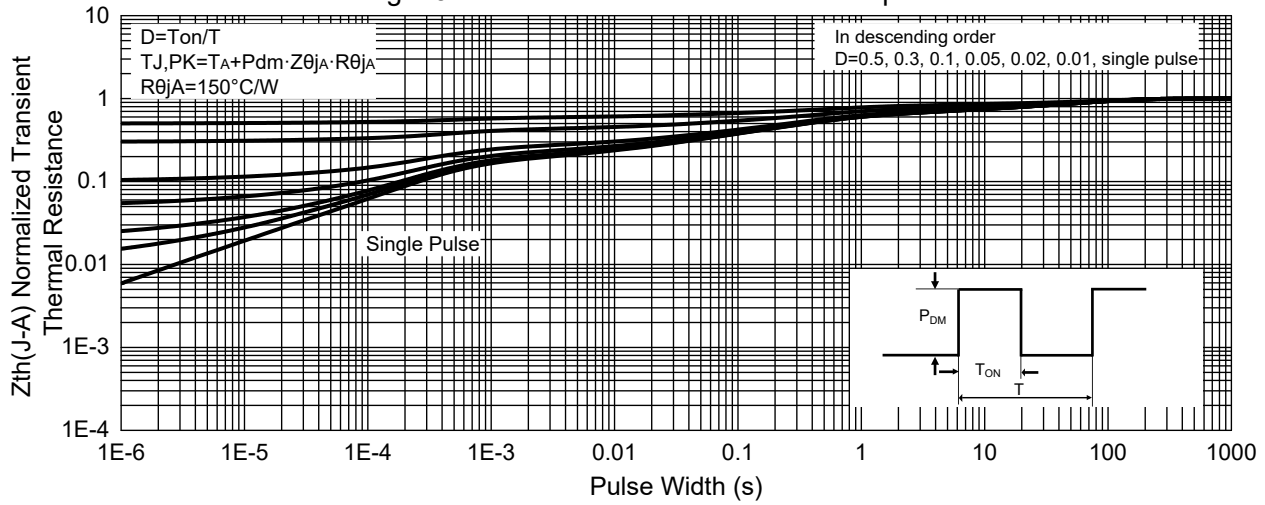

Fig. 13 - Normalized Transient Thermal Impedance



Ordering Information

Device	Packing
Part Number-TP	Tape&Reel:3Kpcs/Reel

IMPORTANT NOTICE

Micro Commercial Components Corp. reserves the right to make changes without further notice to any product herein to make corrections, modifications, enhancements, improvements, or other changes. **Micro Commercial Components Corp.** does not assume any liability arising out of the application or use of any product described herein; neither does it convey any license under its patent rights, nor the rights of others. The user of products in such applications shall assume all risks of such use and will agree to hold **Micro Commercial Components Corp.** and all the companies whose products are represented on our website, harmless against all damages. **Micro Commercial Components Corp.** products are sold subject to the general terms and conditions of commercial sale, as published at <https://www.mccsemi.com/Home/TermsAndConditions>.

LIFE SUPPORT

MCC's products are not authorized for use as critical components in life support devices or systems without the express written approval of Micro Commercial Components Corporation.

CUSTOMER AWARENESS

Counterfeiting of semiconductor parts is a growing problem in the industry. Micro Commercial Components (MCC) is taking strong measures to protect ourselves and our customers from the proliferation of counterfeit parts. MCC strongly encourages customers to purchase MCC parts either directly from MCC or from Authorized MCC Distributors who are listed by country on our web page cited below. Products customers buy either from MCC directly or from Authorized MCC Distributors are genuine parts, have full traceability, meet MCC's quality standards for handling and storage. **MCC will not provide any warranty coverage or other assistance for parts bought from Unauthorized Sources.** MCC is committed to combat this global problem and encourage our customers to do their part in stopping this practice by buying direct or from authorized distributors.

单击下面可查看定价，库存，交付和生命周期等信息

[>>MICRO COMMERCIAL](#)