

CUSTOMER: \_\_\_\_\_

DATE: 2015-5-12

## APPROVAL SPECIFICATION

PRODUCT NAME: SMD power inductor

YOUR PART NO. :

OUR PART NO. : MAPM0420F Seires

VERSION: V1.0

RECEPTION THE SPECIFICATION HAS BEEN ACCEPTED.  DATE:  COMPANY:		
CFMD	CHKD	RCVD

### MANUFACTURING NAME

深圳市麦捷微电子科技股份有限公司  
 SHENZHEN MICROGATE TECHNOLOGY CO., LTD  
 Address: Yuxing road, Golf Street, Guanlan Town  
 Bao' an District Shenzhen P. R. C  
 Postcode :518110  
 TEL: 86-755-28085000  
 FAX: 86-755-28085605

CFMD.	CHKD.	DSGD.
Charles	谢诏虹	刘维

## 目录 CATALOG

	规格书版本控制 Component SPEC Version Record.....	2
1	适用范围 Scope.....	3
2	品名构成 Product Identification.....	4
3	形状、尺寸和材料 Appearance, Dimensions and Material.....	4
4	测试条件 Testing Conditions.....	4
5	电气特性 Electrical Characteristics.....	5
6	信赖性试验 Reliable Performance.....	7-7
7	焊接条件 Recommended Soldering Conditions.....	8-9
8	包装 Packaging.....	9-10
9	存贮条件 Products Storage.....	11

### Component SPEC Version Record

Rev.	Effective Date	Changed Contents	Change Reasons	Approved By
V1.0	2014.12.04	New released	/	Charles

## 1. Scope

This specification applies to the MAPM series of SMD Power inductors.

## 2. Product Identification

MAPM   0420F   -2R2   M   -LF  
 ①            ②            ③            ④            ⑤

- ① Product Symbol
- ② Dimensions
- ③ Inductance Value (2R2:2.2uH   220: 22uH;   101:100uH)
- ④ Inductance Tolerance      (K:10% ; M:20% ; N:30%)
- ⑤ Lead-Free

## 3. Construction

### 3.1 Shape and dimensions

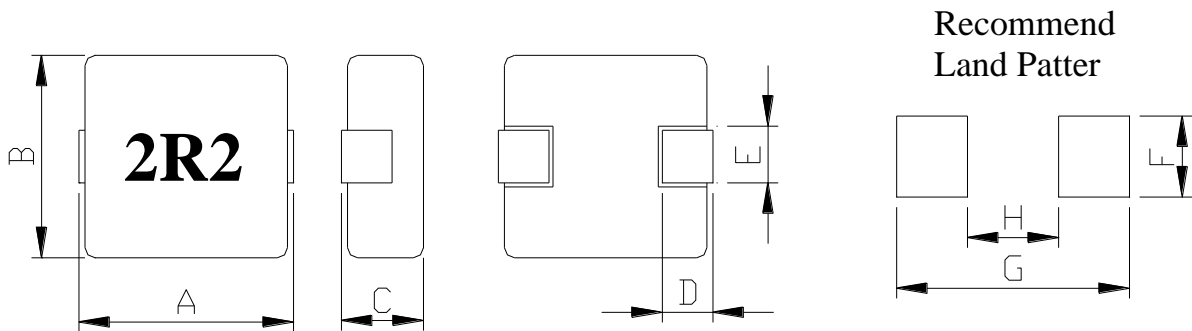

Dimensions in mm								
Model	A	B	C	D	E	F	G	H
MAPM0420F	4.9Max.	4.4Max.	2.0 Max.	1.0±0.3	1.5±0.5	2.30	4.95	2.16

### Material List

No.	Item	Material
1	Core	Carbonyl Iron Powder
2	Wire	Polyester-Imide
3	Terminal	Tin Covered Copper

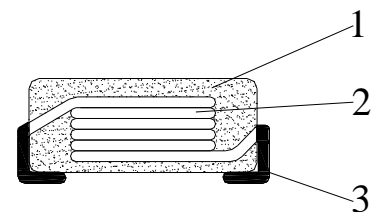

#### 4. Testing Conditions

Unless otherwise specified  
 Temperature : Ordinary Temperature ( 5 to 35°C)  
 Humidity : Ordinary Humidity (<70% RH)  
 Atmospheric Pressure : 86 to 106 kPa

In case of doubt  
 Temperature : 20±2°C  
 Humidity : 50 to 65% RH  
 Atmospheric Pressure : 86 to 106 kPa

#### 5. Electrical Characteristics And Test Instruments

Microgate Part No.	Customer Part No.	Inductance (uH)	DCR (mΩ) Max	Irms (A) Typ.	Isat (A) Typ.
MAPM0420F-R22M-LF		0.22±20%	8	9.0	12.0
MAPM0420F-R36M-LF		0.36±20%	15	7.0	10.0
MAPM0420F-R47M-LF		0.47±20%	14	6.0	9.0
MAPM0420F-R56M-LF		0.56±20%	18	5.0	8.0
MAPM0420F-1R0M-LF		1.0±20%	27	4.5	7.0
MAPM0420F-1R5M-LF		1.5±20%	45	4.0	6.0
MAPM0420F-2R2M-LF		2.2±20%	58	3.0	4.0
MAPM0420F-3R3M-LF		3.3±20%	87	2.0	3.0
MAPM0420F-4R7M-LF		4.7±20%	150	2.0	3.0
MAPM0420F-100M-LF		10±20%	200	1.5	1.8

- \* L test condition: 100KHz/1V ;
- \* Irms: DC current (A) that will cause an approximate Δ T of 40°C.
- \* Isat: DC current (A) that will cause L0 to drop approximately 30%.
- \* All test data is referenced to 25°C ambient.
- \* Operating temperature: -55°C to +125°C
- \* The part temperature (ambient + temp rise) should not exceed 125°C under worse case operating conditions. Circuit design, component placement, PWB trace size and thickness, airflow and other cooling provision all affect the part temperature. Part temperature should be verified in the end application.

## 6. Reliability and Test Condition

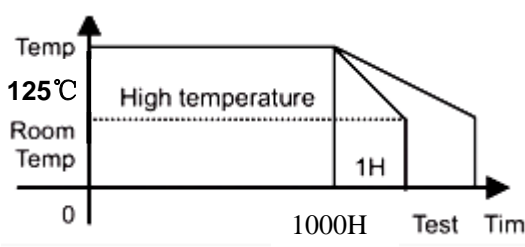
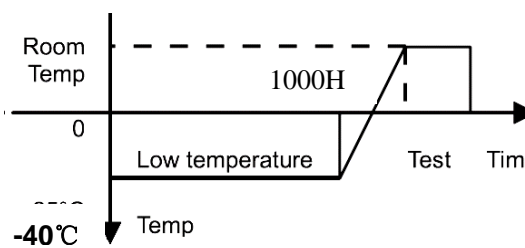
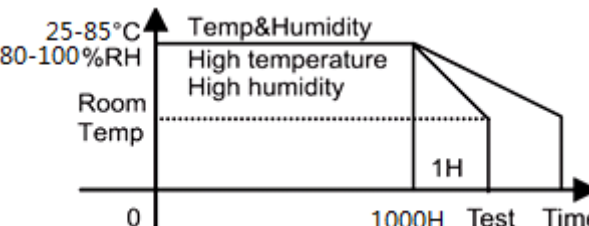
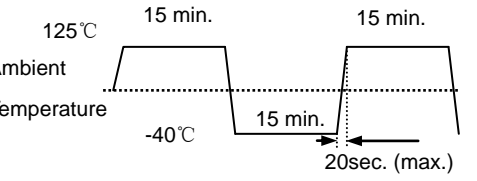
Item	Required Characteristics	Test Method/Condition
High temperature resistance		<p>Temperature: <math>125\pm 2^{\circ}\text{C}</math>            Time : 1000 hours            Measurement at <math>24\pm 4</math> hours after test conclusion.</p> 
Low temperature resistance	<ol style="list-style-type: none"> <li>No case deformation or change in appearance.</li> <li><math> \Delta L /L \leq 10\%</math></li> </ol>	<p>Temperature : <math>-40\pm 2^{\circ}\text{C}</math>            Time : 1000 hours            Measurement at <math>24\pm 4</math> hours after test conclusion.</p> 
Humidity test		<ol style="list-style-type: none"> <li>Exposure : Temperature:<math>25-85^{\circ}\text{C}</math>, Humidity :80-100% RH Time : 1000 hours.</li> <li>Tested while the specimens are still in the chamber.</li> <li>Measurement at <math>24\pm 4</math> hours after test conclusion.</li> </ol> 
Thermal shock test	<ol style="list-style-type: none"> <li>No case deformation or change in appearance.</li> <li><math> \Delta L /L \leq 10\%</math></li> </ol>	<p>First <math>-40^{\circ}\text{C}</math> for T time, last <math>125^{\circ}\text{C}</math> T time as 1 cycle. Go through 1000 cycles.</p> 

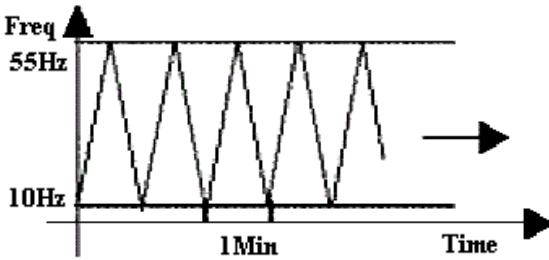
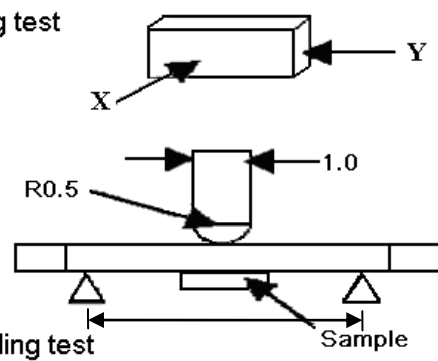
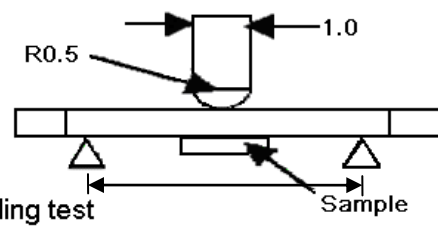
Item	Required Characteristics	Test Method/Condition
Solderability test	Terminal area must have 95% min. solder coverage.	Dip pads in flux then dip in solder pot at $245 \pm 5^\circ\text{C}$ for $5 \pm 0.1$ second. Solder: :Sn96.5%、Ag3%、Cu0.5% Flux: rosin flux.
Heat endurance of reflow soldering		Refer to the next page reflow curve Go through 3 times. The peak temperature: $260 \pm 5^\circ\text{C}$
Vibration test	1. No case deformation or change in appearance. 2. $ \Delta L /L \leq 10\%$	Apply frequency 10~55Hz. 1.5mm amplitude in each of perpendicular direction for 2 hours in each 3 mutually perpendicular directions.(total 6 hours) 
Drop test		Packaged & drop down from 1m with $981\text{m/s}^2(100\text{G})$ attitude in 1 angle 1 ridges & 2surfaces orientations.
Terminal strength push test	<b>Pulling test:</b> Define: Solder the products on testing PCB using eutectic solder. Then apply a force in the direction of the arrow. 17.64N force. Keep time $\geq 10\text{s}$  <b>Bending test:</b> Soldering the products on PCB, after the pulling test and bending test, terminal should not pull off.	Bend the testing PCB at middle point, the deflection shall be 2mm. Pressurizing Speed: 0.5mm/sec, Keep time: $60 \pm 1\text{s}$ , <b>Pulling test</b>  <b>Bending test</b> 
Loading Under Humidity Heat	1. No case deformation or change in appearance. 2. $ \Delta L /L \leq 10\%$	1. Exposure : Temperature: $60 \pm 2^\circ\text{C}$ , Humidity : $93 \pm 3\%$ RH Time : 1000 hours. Apply rated current 2. Tested while the specimens are still in the chamber. 3. Measurement at $24 \pm 4$ hours after test conclusion.
Loading at High Temperature	1. No case deformation or change in appearance. 2. $ \Delta L /L \leq 10\%$	1. Temperature: $85 \pm 2^\circ\text{C}$ 2. Time : 1000 hours 3. Apply rated current 4. Measurement at $24 \pm 4$ hours after test conclusion

## 7. Recommended Soldering Conditions

Product can be applied to flow and reflow soldering.

### (1) Flux, Solder

① Use rosin-based flux. Don't use highly acidic flux with halide content exceeding 0.2wt% (chlorine conversion value).

② Use Sn solder.

### (2) Flow soldering conditions

① Pre-heating should be in such a way that the temperature difference between solder and product surface is limited to 150°C max. Cooling into solvent after soldering also should be in such a way that temperature difference is limited to 100°C max. Unwrought pre-heating may cause cracks on the product, resulting in the deterioration of products quality.

② Standard soldering profile.

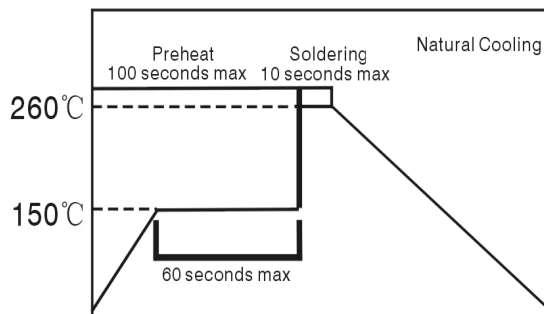

<b>Pre-heating</b>	150°C, 1 minute min
<b>Peak</b>	260°C, 10 seconds max

### (3) Reflow soldering conditions

Profile Feature		Lead-Free Assembly
Average Ramp-Up Rate (Ts max. to Tp)		3°C /second max.
Preheat	- Temperature Min (Ts min.)	150 °C
	- Temperature Max (Ts max.)	200 °C
	- Time (ts min to ts max.)	60-180 seconds
Time maintained above	- Temperature (TL)	217 °C
	- Time (tL)	60-150 seconds
Peak/Classification Temperature (Tp)		260 °C
Peak/Classification Time (Tp)		3-4 seconds
Time within 5 °C of actual Peak Temperature (tp)		20-40 seconds
Ramp-Down Rate		6 °C/second max.
Time 25 °C to Peak Temperature		8 minutes max.

Note 1: All temperatures refer to topside of the package, measured on the package body surface.



Reflow curve

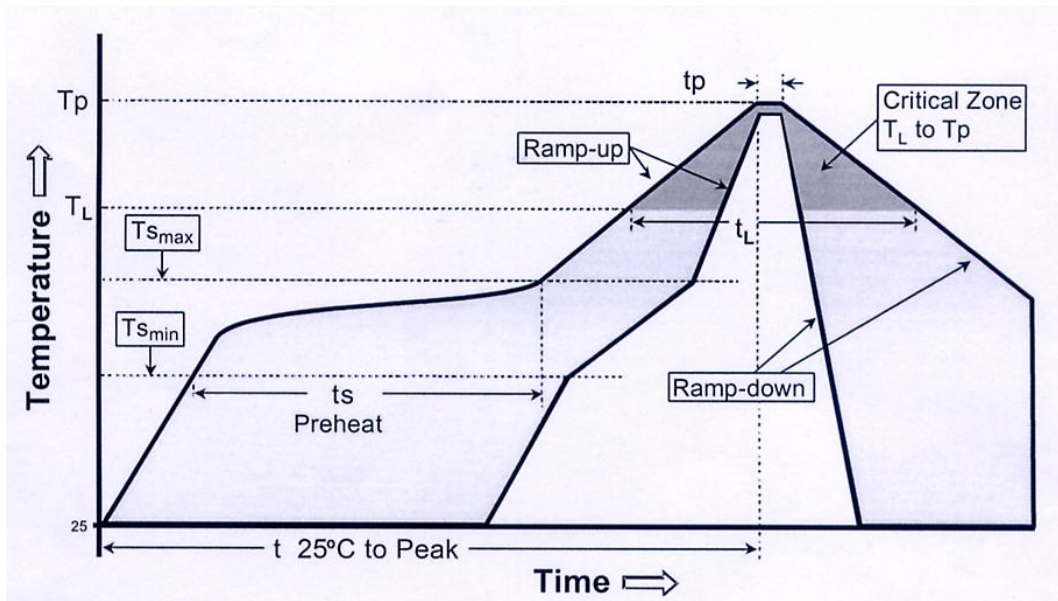

(4) The method on Re-work with using the iron:

The following conditions must be strictly followed when using a soldering iron

Pre-heating	150°C, 1 minute
Tip temperature	280°C max
Soldering iron output	20w max
End of soldering iron	$\phi$ 1mm max
Soldering time	3 seconds max

## 8. Packaging

### 8.1 Dimension of tape (Unit: mm)

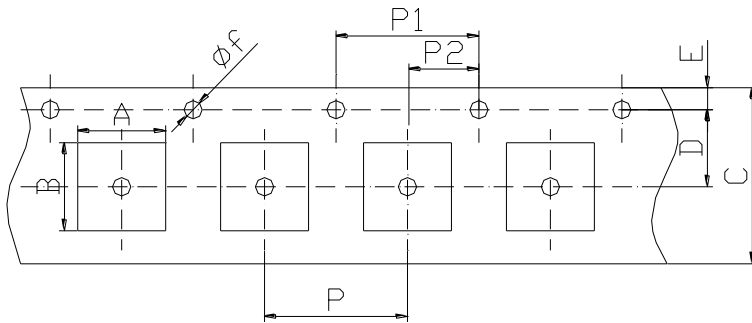

Series	MAPM0420F
A	4.5±0.1
B	5.15±0.1
C	12.0±0.2
D	7.5±0.1
E	1.75±0.1
$\phi f$	1.5±0.1
P	8.0±0.1
P1	4.0±0.1
P2	2.0±0.05

### 9.2 Dimension of reel (Unit: mm)

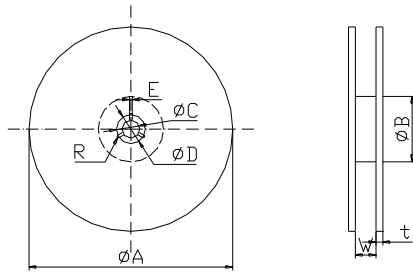

A	330
B	100
C	13.0±1.0
D	20.0±2.0
E	2.0±0.5
R	R1.0
W	12.0±0.5
t	2.0±0.2

### 8.3 Taping figure and drawing direction

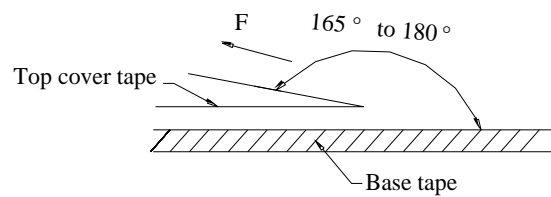
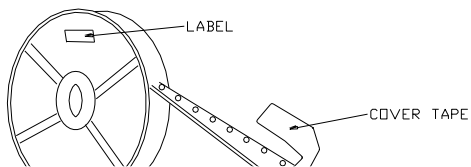

## 9. Products Storage

### (1) Storage period

Products which inspected in MICROGATE over 6 months ago should be examined and used, which can be confirmed with inspection No. marked on the container. Solderability should be checked if this period is exceeded.

### (2) Storage conditions

Products should be storage in the warehouse on the following conditions:

Temperature: -10 ~+ 40°C

Humidity : Less than 80% relative and humidity

No rapid change on temperature and humidity

- (3) Don't keep products in corrosive gases such as sulfur, chlorine gas or acid, or it may cause oxidization of electrode, resulting in poor solderability.
- (4) Products should be storage on the palette for the prevention of the influence from humidity, dust and so on.
- (5) Products should be storage in the warehouse without heat shock, vibration, direct sunlight and so on.
- (6) Products should be storage under the airtight packaged condition.

单击下面可查看定价，库存，交付和生命周期等信息

[>>microgate\(麦捷科技\)](#)