

NOTE

- 嵌合相手: 51382-****
MATE WITH: 51382-****
- 偶数極(列)に適用。
APPLY EVEN CIRCUIT PRODUCTS.
- キンクは両外側の位置に付加。
KINK TO BE APPLIED BOTH ENDS.
- 材質
ハウジング: ポリエステル(PBT) UL94V-0
MATERIALS HOUSING: POLYESTER(PBT) UL94V-0
ピン: 黄銅
PIN: BRASS
- めっき
ピン: 錫めっき, リフロー処理(前めっき) めっき厚: 1.0µm MIN.
ニッケル下地めっき, めっき厚: 0.5µm MIN.
FINISHES PIN: PRE-TIN PLATED, (HEAT TREATED MATTE TIN)
PLATING THICKNESS: 1.0µm MIN.
NICKEL UNDERPLATE OVERALL
PLATING THICKNESS: 0.5µm MIN.
- 製品番号 MATERIAL NO.
55935-****

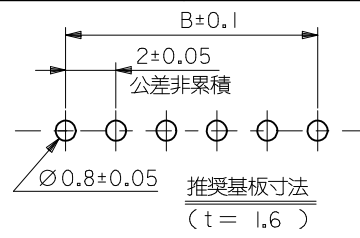

極数 CIRCUIT SIZE | 色 COLOR

- 7. トレードマーク: Mプラス1~2文字のアルファベットにて構成。(例:MXJ) 但し, "J"はJAPANを示す。
FORMED BY M AND 1-2 MORE LETTER OF ALPHABET(e.g. MXJ) TO TRADE MARK, BUT "J" SHOW JAPAN.
- 8. キャビティ番号: 1~2桁の数字
金型番号: アルファベット1文字にて構成(例 1A, 10B)
尚、金型番号は刻印無し製品あり。
FORMED BY 1 DIGIT TO " DIGIT NUMBERS (TO CAVITY No.) AND BY 1 LETTER OF ALPHABET. (TO MOLD No.) (e.g. 1A,10B)
THERE ARE PRODUCTS WITHOUT THE MARK OF MOLD No.

30	自然色(白)	NATURAL(WHITE)
31	黒	BLACK
32	赤	RED
33	黄	YELLOW
34	青	BLUE
35	桃	PINK
36	緑	GREEN
37	茶	BROWN
38	橙	ORANGE
39	紫	VIOLET
51	灰	GRAY
53	蛍光黄	FLUORESCENT YELLOW
54	水	PALE BLUE
55	蛍光桃	FLUORESCENT PINK
56	黄緑	YELLOWISH GREEN
58	蛍光橙	FLUORESCENT ORANGE

31	28	34	55935-15**	15
29	26	32	55935-14**	14
27	24	30	55935-13**	13
25	22	28	55935-12**	12
23	20	26	55935-11**	11
21	18	24	55935-10**	10
19	16	22	55935-09**	9
17	14	20	55935-08**	8
15	12	18	55935-07**	7
13	10	16	55935-06**	6
11	8	14	55935-05**	5
9	6	12	55935-04**	4
7	4	10	55935-03**	3
5	2	8	55935-02**	2
C	B	A	MATERIAL NO.	CKT.

REVISED EC NO.: J2017-0522 2017/04/11 DRW:KUSATO 2017/04/11 CHK:DAIDA 2017/04/13 APPR:KANAKO	GENERAL TOLERANCES (UNLESS SPECIFIED)		DIMENSION STYLE MM ONLY		SCALE ---	DESIGN UNITS METRIC	THIRD ANGLE PROJECTION
	0.25 UNDER	UNDER	±0.03	DRAWN BY T. NIITSU	DATE '02/02/08	TITLE 2.0 W/B SINGLE CONN. PLUG HOUSING ASS'Y R/A -LEAD FREE-	
	0.25 OVER	0.5 UNDER	±0.05	CHECKED BY K. ASAKAWA	DATE '03/06/12		
	0.5 OVER	1.0 UNDER	±0.1	APPROVED BY T. YAMAGUCHI	DATE '03/06/12		
1.0 OVER	10 UNDER	±0.2	MATERIAL NO.		DOCUMENT NO.	SHEET NO.	
10 OVER	30 UNDER	±0.25	SEE CHART		SD-55935-002	1 OF 2	
30 OVER		±0.3	THIS DRAWING CONTAINS INFORMATION THAT IS PROPRIETARY TO MOLEX ELECTRONIC TECHNOLOGIES, LLC AND SHOULD NOT BE USED WITHOUT WRITTEN PERMISSION				
ANGULAR	±3 °						
DRAFT WHERE APPLICABLE MUST REMAIN WITHIN DIMENSIONS							

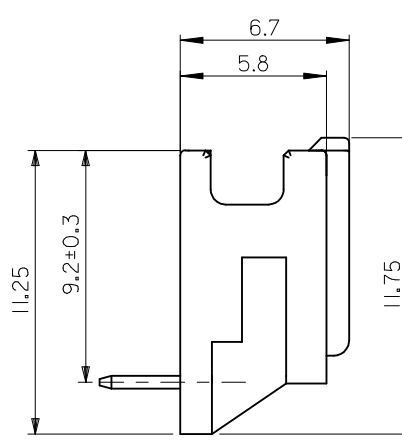
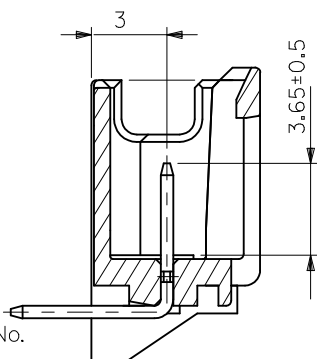
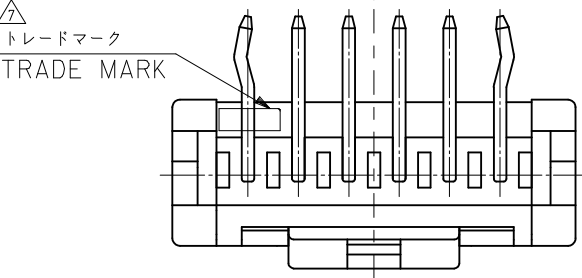
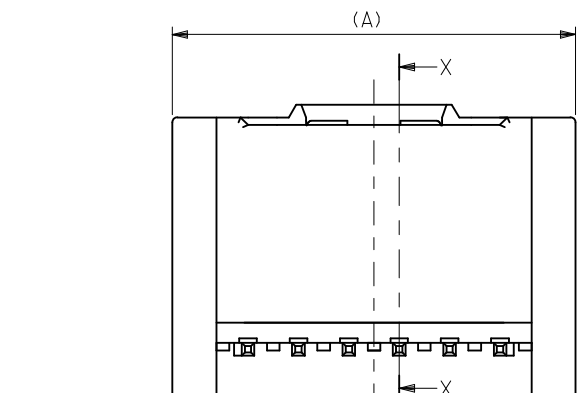
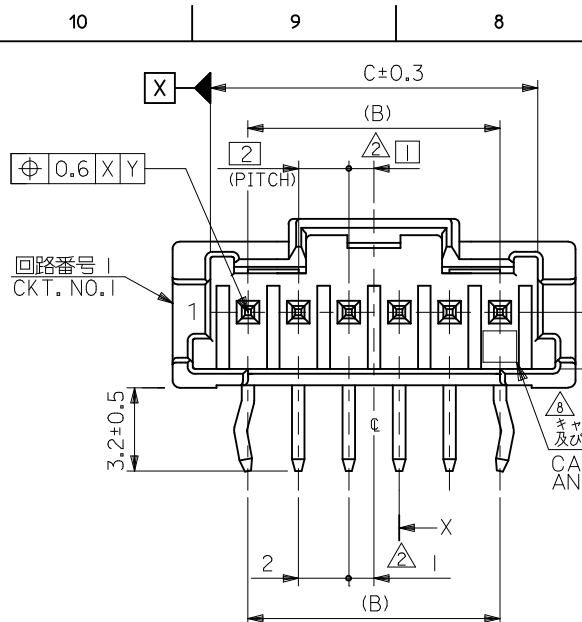

NOTE

- 嵌合相手: 51382-****
MATE WITH: 51382-****
- 偶数極(列)に適用。
APPLY EVEN CIRCUIT PRODUCTS.
- キンクは両外側の位置に付加。
KINK TO BE APPLIED BOTH ENDS.
- 材質
ハウジング: ポリエステル(PBT) UL94V-0
MATERIALS HOUSING: POLYESTER(PBT) UL94V-0
ピン: 黄銅
PIN: BRASS
- めっき
ピン: 錫めっき, リフロー処理(前めっき) めっき厚: 1.0µm MIN.
ニッケル下地めっき, めっき厚: 0.5µm MIN.
FINISHES PIN: PRE-TIN PLATED, (HEAT TREATED MATTE TIN)
PLATING THICKNESS: 1.0µm MIN.
NICKEL UNDERPLATE OVERALL
PLATING THICKNESS: 0.5µm MIN.
- 製品番号 MATERIAL NO.
55935-****

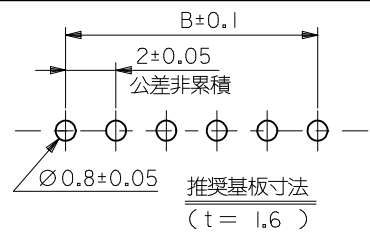

極数 CIRCUIT SIZE 色 COLOR

- △1 トレードマーク: Mプラス1~2文字のアルファベットにて構成。(例:MXJ) 但し, "J"はJAPANを示す。FORMED BY M AND 1-2 MORE LETTER OF ALPHABET(e.g. MXJ) TO TRADE MARK, BUT "J" SHOW JAPAN.
- △8 キャビティ番号: 1~2桁の数字 金型番号: アルファベット1文字にて構成(例 1A, 10B) 尚、金型番号は刻印無し製品あり。FORMED BY 1 DIGIT TO " DIGIT NUMBERS (TO CAVITY No.) AND BY 1 LETTER OF ALPHABET. (TO MOLD No.) (e.g. 1A,10B) THERE ARE PRODUCTS WITHOUT THE MARK OF MOLD No.

30	自然色(白)	NATURAL(WHITE)
31	黒	BLACK
32	赤	RED
33	黄	YELLOW
34	青	BLUE
35	桃	PINK
36	緑	GREEN
37	茶	BROWN
38	橙	ORANGE
39	紫	VIOLET
51	灰	GRAY
53	蛍光黄	FLUORESCENT YELLOW
54	水	PALE BLUE
55	蛍光桃	FLUORESCENT PINK
56	黄緑	YELLOWISH GREEN
58	蛍光橙	FLUORESCENT ORANGE

31	28	34	55935-15**	15
29	26	32	55935-14**	14
27	24	30	55935-13**	13
25	22	28	55935-12**	12
23	20	26	55935-11**	11
21	18	24	55935-10**	10
19	16	22	55935-09**	9
17	14	20	55935-08**	8
15	12	18	55935-07**	7
13	10	16	55935-06**	6
11	8	14	55935-05**	5
9	6	12	55935-04**	4
7	4	10	55935-03**	3
5	2	8	55935-02**	2
C	B	A	MATERIAL NO.	CKT.

REVISED EC NO.: J2017-0522 2017/04/11 DRW:KUSATO 2017/04/11 CHK:DAIDA 2017/04/13 APPR:TKANEKO	GENERAL TOLERANCES (UNLESS SPECIFIED)		DIMENSION STYLE MM ONLY		SCALE ---	DESIGN UNITS METRIC	THIRD ANGLE PROJECTION
	0.25 UNDER	UNDER	±0.03	DRAWN BY T. NIITSU	DATE '02/02/08	TITLE 2.0 W/B SINGLE CONN. PLUG HOUSING ASS'Y R/A -LEAD FREE-	
	0.25 OVER	0.5 UNDER	±0.05	CHECKED BY K. ASAKAWA	DATE '03/06/12		
	0.5 OVER	1.0 UNDER	±0.1	APPROVED BY T. YAMAGUCHI	DATE '03/06/12		
1.0 OVER	10 UNDER	±0.2	MATERIAL NO.		DOCUMENT NO.	SHEET NO.	
10 OVER	30 UNDER	±0.25	SEE CHART		SD-55935-002	1 OF 2	
30 OVER		±0.3	THIS DRAWING CONTAINS INFORMATION THAT IS PROPRIETARY TO MOLEX ELECTRONIC TECHNOLOGIES, LLC AND SHOULD NOT BE USED WITHOUT WRITTEN PERMISSION				
ANGULAR	±3 °						
DRAFT WHERE APPLICABLE MUST REMAIN WITHIN DIMENSIONS							

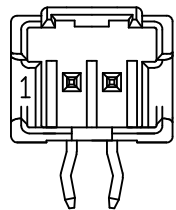
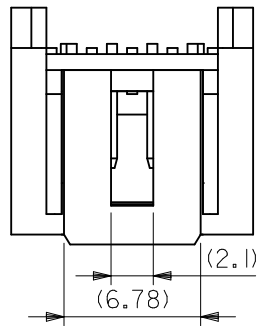
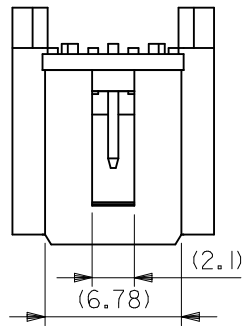
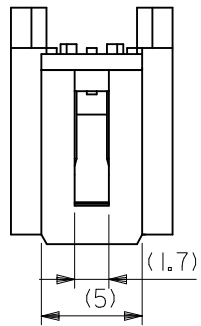

2 CIRCUIT

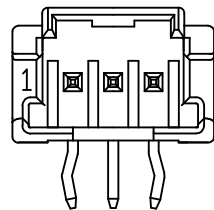

3 CIRCUIT

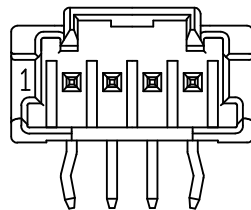

4 CIRCUIT 以上

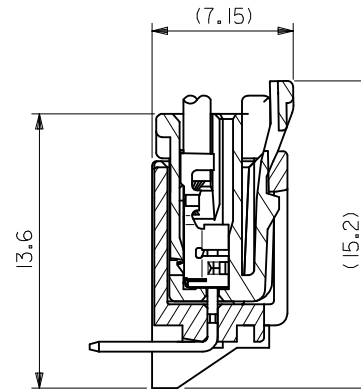

嵌合断面図

MODEL NO. : 55935-****

REVISED EC NO. : J2017-0522 DRW:KUSATO 2017/04/11 CHK:DAIDA 2017/04/11 APPR:KANeko 2017/04/13	GENERAL TOLERANCES (UNLESS SPECIFIED)			DIMENSION STYLE MM ONLY		SCALE ---	DESIGN UNITS METRIC	THIRD ANGLE PROJECTION
	0.25 UNDER	UNDER	± 0.03	DRAWN BY	DATE	TITLE		
	0.25 OVER	0.5 UNDER	± 0.05	T. NIITSU	'02/02/08	2.0 W/B SINGLE CONN. PLUG HOUSING ASS'Y R/A -LEAD FREE-		
	0.5 OVER	1.0 UNDER	± 0.1	CHECKED BY	DATE	molex DOCUMENT NO. SD-55935-002 SHEET NO. 2 OF 2		
	1.0 OVER	10 UNDER	± 0.2	K. ASAKAWA	'03/06/12			
	10 OVER	30 UNDER	± 0.25	APPROVED BY	DATE	THIS DRAWING CONTAINS INFORMATION THAT IS PROPRIETARY TO MOLEX ELECTRONIC TECHNOLOGIES, LLC AND SHOULD NOT BE USED WITHOUT WRITTEN PERMISSION		
30 OVER		± 0.3	T. YAMAGUCHI	'03/06/12				
ANGULAR	± 3 °		MATERIAL NO.					
DRAFT WHERE APPLICABLE MUST REMAIN WITHIN DIMENSIONS				SIZE A3				

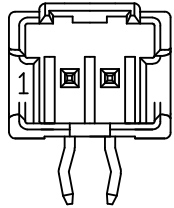
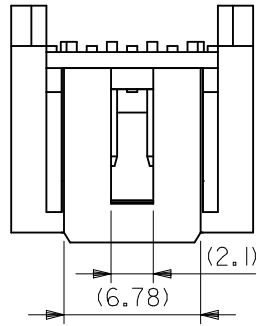
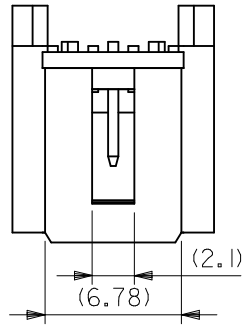
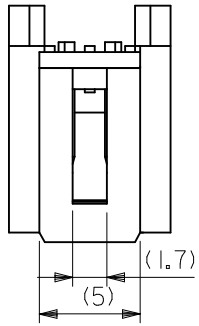

2 CIRCUIT

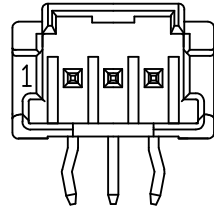

3 CIRCUIT

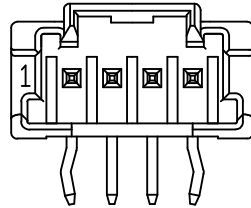

4 CIRCUIT 以上

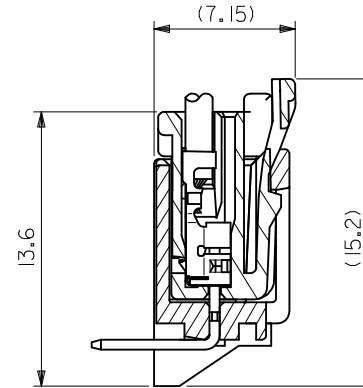

嵌合断面図

MODEL NO. : 55935-****

REVISED EC NO. : J2017-0522 DRW:KUSATO 2017/04/11 CHK:DAIDA 2017/04/11 APPR:KANeko 2017/04/13	GENERAL TOLERANCES (UNLESS SPECIFIED)			DIMENSION STYLE MM ONLY		SCALE ---	DESIGN UNITS METRIC	THIRD ANGLE PROJECTION
	0.25 UNDER	UNDER	± 0.03	DRAWN BY T. NIITSU	DATE '02/02/08	TITLE 2.0 W/B SINGLE CONN. PLUG HOUSING ASS'Y R/A -LEAD FREE-		
	0.25 OVER	0.5 UNDER	± 0.05	CHECKED BY K. ASAKAWA	DATE '03/06/12	molex DOCUMENT NO. SD-55935-002 SHEET NO. 2 OF 2		
	0.5 OVER	1.0 UNDER	± 0.1	APPROVED BY T. YAMAGUCHI	DATE '03/06/12			
	1.0 OVER	10 UNDER	± 0.2	MATERIAL NO.		SEE CHART		
	10 OVER	30 UNDER	± 0.25	SIZE A3		THIS DRAWING CONTAINS INFORMATION THAT IS PROPRIETARY TO MOLEX ELECTRONIC TECHNOLOGIES, LLC AND SHOULD NOT BE USED WITHOUT WRITTEN PERMISSION		
30 OVER		± 0.3	DRAFT WHERE APPLICABLE MUST REMAIN WITHIN DIMENSIONS					

单击下面可查看定价，库存，交付和生命周期等信息

[>>MOLEX](#)