

RECEPTACLE

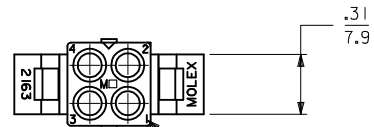

CIRCUIT NUMBERS

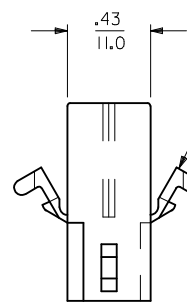

MOUNTING EAR
(WHEN SPECIFIED)
SEE DETAIL B

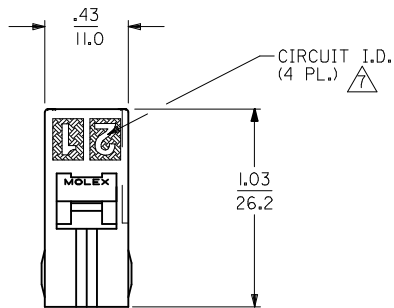

CIRCUIT I.D.
(4 PL.)

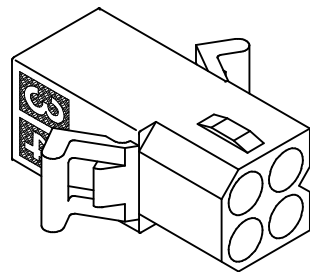
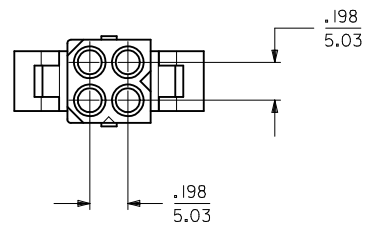

SHOWN WITH PREBENT MOUNTING EAR

PLUG

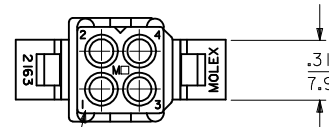

CIRCUIT NUMBERS

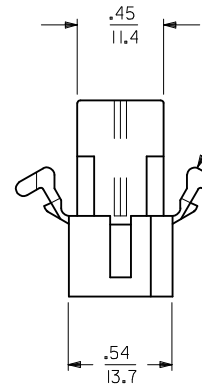

MOUNTING EAR
(WHEN SPECIFIED)
SEE DETAIL B

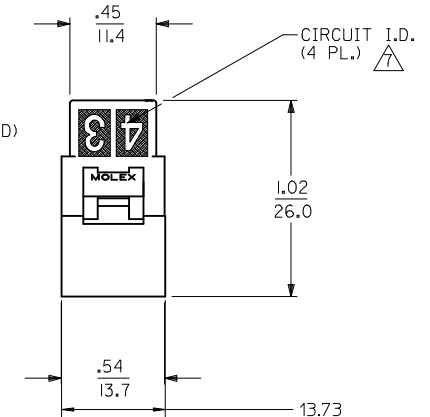

CIRCUIT I.D.
(4 PL.)

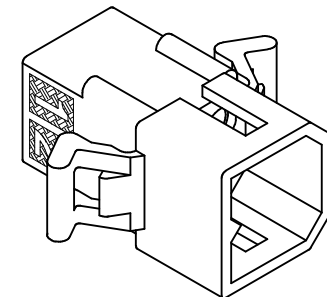
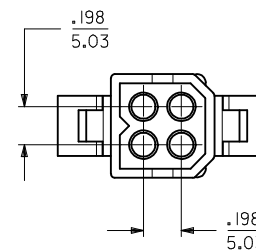

SHOWN WITH PREBENT MOUNTING EAR

REMOVE OBSOLETE EC NO: UCP2016-2183 DRWN:KIPPER 2015/12/10 CHKD:JBELL 2015/12/10 APPR:FSMITH 2015/12/23	QUALITY SYMBOLS ▽=0 ▽=0 ▽=0	GENERAL TOLERANCES (UNLESS SPECIFIED)		DIMENSION STYLE IN/MM		SCALE 2:1	DESIGN UNITS INCH	THIRD ANGLE PROJECTION
		4 PLACES ± --- ± --- 3 PLACES ± --- ± .010 2 PLACES ± 0.25 ± .014 1 PLACE ± 0.35 ± --- 0 PLACE ± --- ± ---	mm INCH DRAWN BY DATE KBW 02/03/89 CHECKED BY DATE RW 02/03/89 APPROVED BY DATE FSMITH 2014/06/23	TITLE .093/(2.36) HOUSINGS PLUG & RECEPTACLE 4 CKT., .198/(5.03) CL		MATERIAL NO. SEE CHART		DOCUMENT NO. SD-2163-*
DRAFT WHERE APPLICABLE MUST REMAIN WITHIN DIMENSIONS		THIS DRAWING CONTAINS INFORMATION THAT IS PROPRIETARY TO MOLEX INCORPORATED AND SHOULD NOT BE USED WITHOUT WRITTEN PERMISSION						

PLUG	
ORDER NO	ENG NO
03-09-2049	2163-P1
46999-0652	2163-P2

RECEPTACLE	
ORDER NO	ENG NO
03-09-1049	2163-R1
03-09-6049	2163-R1BK
46999-0653	2163-R2

LEGEND:

2163-****

P = PLUG
R = RECEPTACLE

BLANK = OBSOLETE
1 = WITHOUT EARS
2 = WITH PREBENT EARS
3 = OBSOLETE
4 = OBSOLETE

COLOR:
BLANK = NATURAL COLOR
AM = AMBER BK = BLACK BU = BLUE
BN = BROWN GY = GRAY GN = GREEN
OR = ORANGE RD = RED YW = YELLOW
UV = BLACK UV RESISTANT

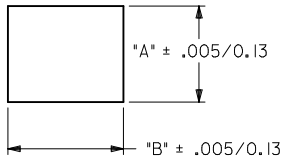
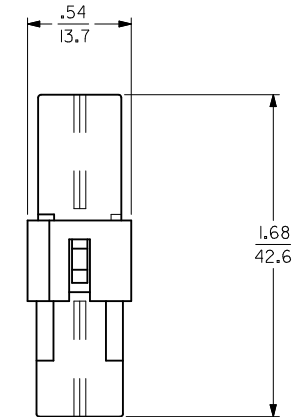
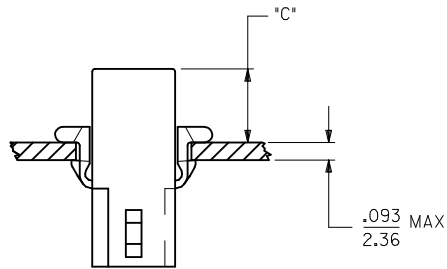

RECOMMENDED PANEL OPENING

HOUSING	DIM. "A"	DIM. "B"	"C" PREBENT EAR
PLUG	.555/14.10	.695/17.65	.42/10.7
RECEPT.	.500/12.70	.600/15.24	.40/10.2

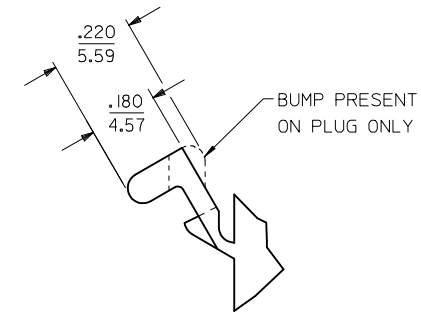

NOTES:

- MATERIAL: NYLON 6/6 (PA), UL 94V-2.
- FINISH: NONE.
- PRODUCT SPECIFICATION: PS-02-09 APPLIES.
- PARTS TO BE PACKAGED PER PK-2163-001
- MATES WITH: SERIES 2163.
- ACCEPTS MOLEX .093 SERIES TERMINALS.
- CIRCUIT I.D. NUMBERS ON HOUSING APPEAR ON PARTS FROM TOOLS BUILT AFTER 7/22/91.
- PARTS CONFORM TO CLASS B REQUIREMENTS OF COSMETIC SPECIFICATION PS-45499-002

SEE SHEET 1 EC NO: UCP2016-2183 DRW:MK/PPER 2015/12/10 CHKD:JBELL 2015/12/10 APPR:FSMITH 2015/12/23	QUALITY SYMBOLS ∇=0 ∇=0 ∇=0	GENERAL TOLERANCES (UNLESS SPECIFIED)		DIMENSION STYLE IN/MM	SCALE 2:1	DESIGN UNITS INCH	THIRD ANGLE PROJECTION
		4 PLACES ± --- ± --- 3 PLACES ± --- ± .010 2 PLACES ± 0.25 ± .014 1 PLACE ± 0.35 ± --- 0 PLACE ± --- ± ---	mm INCH DRAWN BY DATE KBW 02/03/89 CHECKED BY DATE RW 02/03/89 APPROVED BY DATE FSMITH 2014/06/23	TITLE .093/(2.36) HOUSINGS PLUG & RECEPTACLE 4 CKT., .198/(5.03) CL			
		ANGULAR ± --- °		MATERIAL NO. SEE CHART	DOCUMENT NO. SD-2163-*	SHEET NO. 2 OF 2	
		DRAFT WHERE APPLICABLE MUST REMAIN WITHIN DIMENSIONS		THIS DRAWING CONTAINS INFORMATION THAT IS PROPRIETARY TO MOLEX INCORPORATED AND SHOULD NOT BE USED WITHOUT WRITTEN PERMISSION			

单击下面可查看定价，库存，交付和生命周期等信息

[>>MOLEX](#)