

FFC/FPC Connectors, 0.50mm Pitch, Double Bottom Contacts

molex[®]

Molex's 0.50mm pitch FFC/FPC connectors with double the contacts per circuit offer the best combination of signal reliability, compactness, wide circuit size range and cable style choices of any similar version in the market

Features and Benefits

Contact design with two lower contacts per circuit	Ensures a clean mating interface and provides superior contact reliability
Cable ear-tab locking feature	Provides cable alignment, high retention force and easy actuation
Zero insertion force	Facilitates easy cable insertion
Wide range of circuit sizes (4-80)	Offers design flexibility
Vacuum pick-and-place area on top of housing	Provides easier board assembly and cost savings versus separate pick-and-place tape

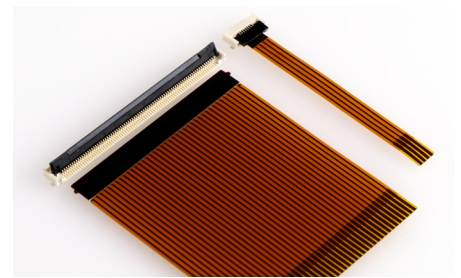

Standard Cable Type, 1.90mm Height (FD19)
(505110 Series)

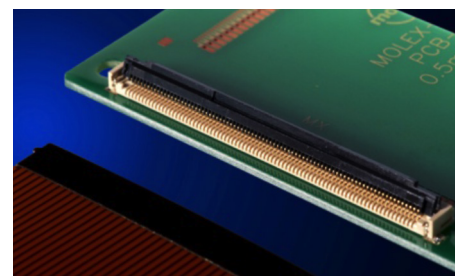

Standard Cable Type, 2.50mm Height
(502790 Series)



Non-standard Cable Type, 2.50mm Height
(104060 Series)

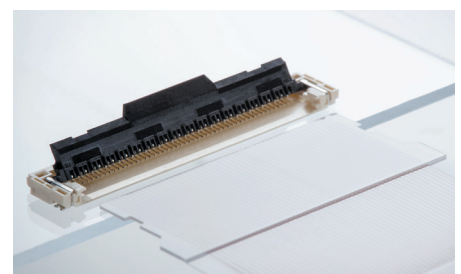

Notched Cable Type, 1.50mm Height
(104234 Series)

Applications

Automobile Infotainment

- Display Audio
- Car Navigation

Consumer

- Flat Panel TV
- Portable Game
- Personal Navigation Equipment

Datacommunications

- Optical Disk Drives
- Tablet and Notebook PCs
- Printers and Copiers



Flat Panel TV



Automobile Infotainment



Optical Disk Drives

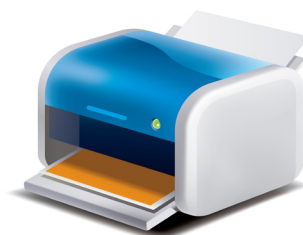

Printer

FFC/FPC Connectors, 0.50mm Pitch, Double Bottom Contacts



Specification

REFERENCE INFORMATION

Packaging: Embossed tape
Designed In: Millimeters
RoHS: Yes
Halogen Free: Low Halogen

ELECTRICAL

Voltage (max.): 50V
Current (max.): 0.5A
Contact Resistance: 40 milliohms max.
Dielectric Withstanding Voltage:
505110/502790: 125V AC (rms)
104060/104234: 250V AC (rms)
Insulation Resistance: 50 Megohm min.

PHYSICAL

Housing: LCP (Beige); 104234 Series (Natural)
Actuator: Polyamide Glass Filled (Black)
Terminal: Phosphor Bronze
Fitting Nail: Phosphor Bronze

PLATING

Contact Area: Separated Gold
Solder Tail Area: Separated Gold
Underplating: Nickel
Operating Temperature:
505110/502790: -40 to +105°C
104060/104234: -20 to +85°C

MECHANICAL

Durability (min.): 25 cycles

Ordering Information

Order No.	Height	Depth	Cable Type	Circuit Size
104234-**-17	1.50mm	5.30mm	Notched	51
505110-**-92	1.90mm		Standard	04-19
505110-**-91			Standard	20, 22, 24, 26, 28, 30, 35, 40, 45, 50, 60, 64, 68, 70, 80
502790-**-91	2.50mm		Standard	30, 40, 50, 60, 64, 80
104060-**-17		Non-standard	60, 80	

(Replace ** with circuit size)

Additional Product Features

Double-Bottom-Contact Terminal Design

The double-bottom-contact terminal design (right) removes dust and contaminants better than single-bottom-contact terminals, while providing stable redundant contact forces for secure electrical reliability.

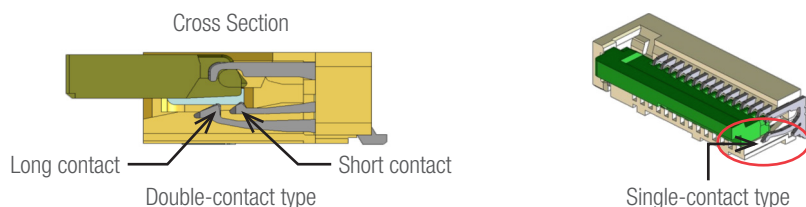

Ultra-Low-Profile Feature

Various profile heights to meet different design requirements.

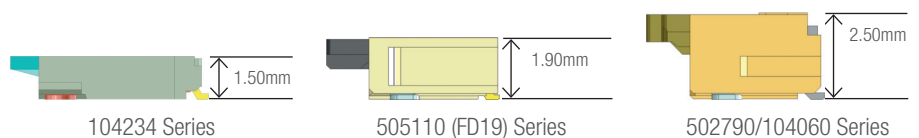

Cable Locking Features

Various cable locking features to meet different design requirements.

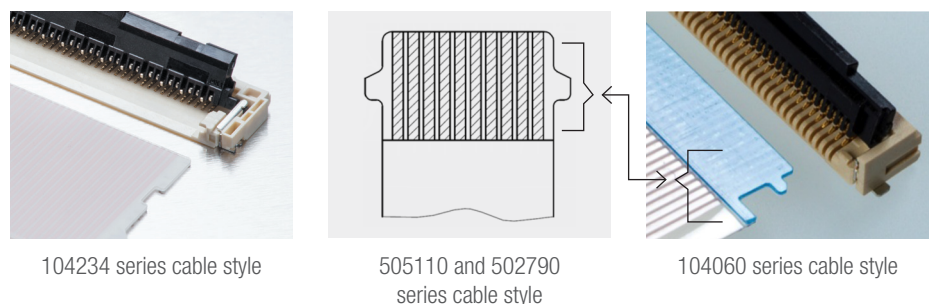

www.molex.com/product/smt_ffc-fpc.html

单击下面可查看定价，库存，交付和生命周期等信息

[>>MOLEX](#)