

# MSKSEMI 美森科

SEMICONDUCTOR



ESD



TVS



TSS



MOV



GDT



PLED

## 74HC4053-MS

产品规格手册

## 概述

74HC4053-MS 是一款采用先进 CMOS 技术设计的 3 路双通道多路模拟复用器。是一个单刀双掷配置形式的模拟开关。具有三个独立的通道控制输入 A、B、C 和一个使能输入 INH。通道控制输入信号 A、B、C，分别控制 3 路开关两个通道中的一个通道开启，另一通道关闭。

## 产品用途

- 模拟和数字多路复用与解复用
- 数字寻址信号的逻辑电平转换
- 路复用与解复用
- 其它应用领域

## 特征

- 低输入电流： $I_{IN} \leq 1\mu A$ , @ $V_{IN}=V_{DD}-V_{SS}=15V$ ,  $T_a=25^\circ C$
- 低静态功耗： $I_{DD}=0.2\mu A$  (典型) @ $V_{DD}-V_{SS}=15V$ ,  $T_a=25^\circ C$
- 低通电阻： $90\Omega$  (典型) @ $V_{DD}-V_{SS}=V_{DD}-V_{EE}=15V$ ,  $T_a=25^\circ C$
- 通道漏电流： $\pm 100pA$  (典型) @ $V_{DD}-V_{EE}=15V$
- 宽工作电压  $V_{DD}-V_{SS}$  范围： $3V \sim 15V$
- 先断后通切换消除了通道重迭开启
- 单刀双掷配置形式的模拟开关

## 参考信息

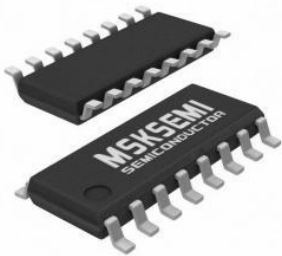
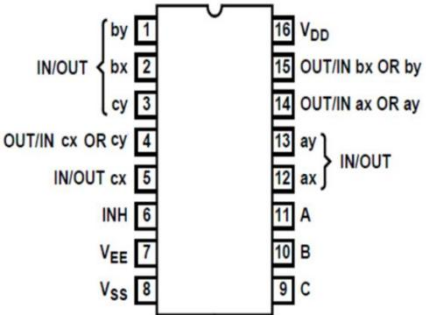
封装图	脚位信息
	
SOP-16	管脚功能定义

## 封装形式和管脚功能定义

管脚序号	管脚定义	说明	管脚序号	管脚定义	说明
1	IN/OUT by	by 通道	16	VDD	电源正
2	IN/OUT bx	bx 通道	15	OUT/IN bx OR by	b 通道公共端
3	IN/OUT cy	cy 通道	14	OUT/IN ax OR ay	a 通道公共端
4	OUT/IN cx OR cy	c 通道公共端	13	IN/OUT ay	ay 通道
5	IN/OUT cx	cx 通道	12	IN/OUT ax	ax 通道
6	INH	使能控制	11	A	通道控制输入 A
7	VEE	模拟开关负电源	10	B	通道控制输入 B
8	VSS	电源地	9	C	通道控制输入 C

**极限值**

参数	符号	极限值	单位
直流电源电压	$V_{DD}-V_{SS}$	-0.5~18	V
模拟电源电压	$V_{DD}-V_{EE}$	18	V
直流输入电压	$V_{IN}$	-0.5+ $V_{SS}$ ~ $V_{DD}+0.5V$	V
功耗	$P_D$	500	mW
工作温度	$T_A$	-40~85	°C
存储温度	$T_S$	-65~150	°C
引脚焊接温度	$T_W$	260, 10s	°C

注: 极限参数是指无论在任何条件下都不能超过的极限值。如果超过此极限值, 将有可能造成产品劣化等物理性损伤; 同时在接近极限参数下, 不能保证芯片可以正常工作。

**原理逻辑图**

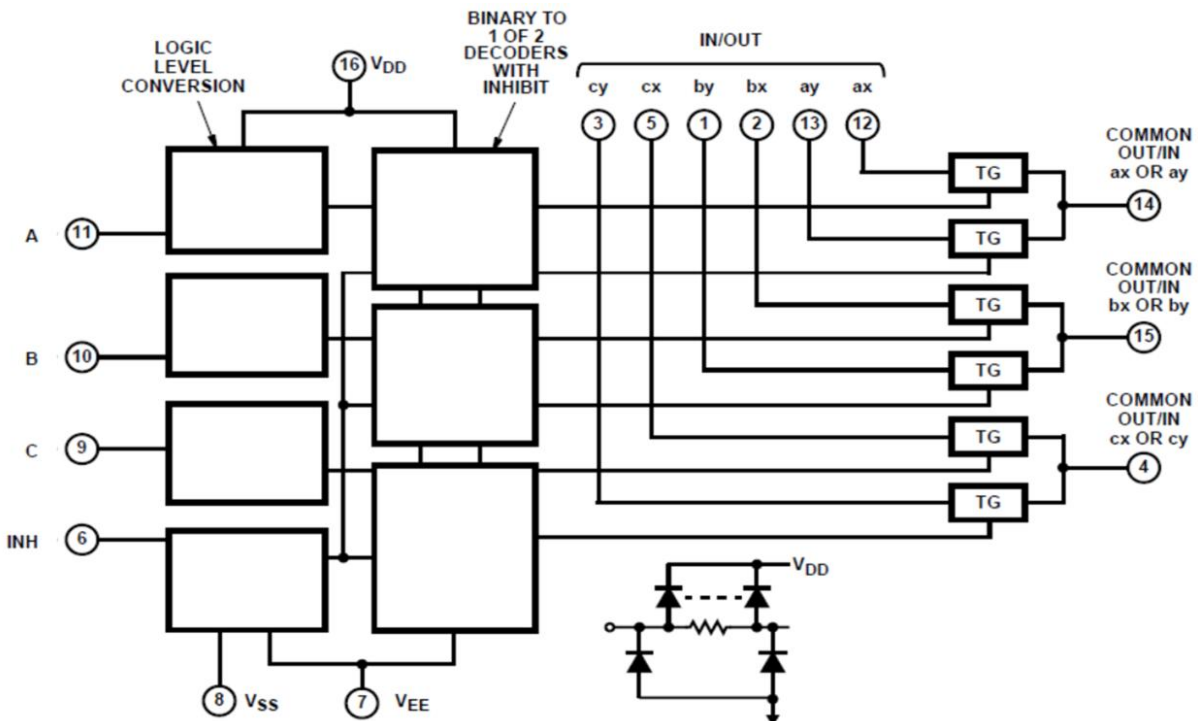

**真值表**

INPUTS		OUTPUTS
INH	A or B or C	"ON" CHANNEL
0	0	ax or bx or cx
0	1	ay or by or cy
1	×	None

×:任意值

推荐工作条件

项目	符号	最小值	典型值	最大值	单位
直流电源电压	$V_{DD}-V_{SS}$	3		15	V
控制输入电压	$V_{IS}$	0		$V_{DD}-V_{SS}$	V
模拟电源电压	$V_{DD}-V_{EE}$	0		15	V
模拟输入输出电压	$V_{IN}$ 、 $V_{OUT}$	0		$V_{DD}-V_{EE}$	V
工作温度	$T_A$	-40		85	°C

电学特性

直流电学特性: ( $V_{IS}=V_{IN}-V_{SS}$ ,  $V_{EE}=V_{SS}$ ,  $R_L = 3k\Omega$ ,  $T_A=25^\circ C$  除非特别指定)

符号	项目	测试条件		VDD (V)	最小值	典型值	最大值	单位
$V_{IH}$	高电平有效 输入电压	$V_{IH}=V_{DD}$ through 1k	$V_{EE}=V_{SS}$ , $R_L=1k\Omega$ to $V_{SS}$ ,	5	3.5			V
				10	7			V
				15	11			V
$V_{IL}$	低电平有效 输入电压	$V_{IL}=V_{DD}$ through 1k	$I_{IS}<2\mu A$ on all OFF Channels	5			1.5	V
				10			3	V
				15			4	V
$R_{ON}$	导通电阻	$0 \leq V_{IS} \leq V_{DD}$		5		180		$\Omega$
				10		115		
				15		90		
$\Delta R_{ON}$	相邻通道导通电 阻差			5		15		$\Omega$
				10		10		
				15		5		
$I_{OFF}$	漏电流	输入输出通道关闭, $INH=V_{DD}$		18			$\pm 100$	nA
$I_{IN}$	输入电流	$V_{IN}=V_{DD}$ or $V_{SS}$		18		0.01	$\pm 0.1$	$\mu A$
$I_{DD}$	静态电流	$V_{IN}=V_{DD}$ or $V_{SS}$		5		0.01	5	$\mu A$
				10		0.01	10	$\mu A$
				15		0.01	20	$\mu A$
$C_{IN}$	输入电容	任意输入端				5	7.5	pF
$C_{IS}$	通道输入电容					5		pF
$C_{OS}$	输出电容					9		pF
$C_{IOS}$	导通电容					0.2		pF

交流电学特性: ( $V_{SS}=V_{EE}$ ,  $T_A=25^\circ C$ ,  $t_r=t_f=20ns$ ,  $t_{pd}$  包含  $t_{PHL}$ 、 $t_{PLH}$ , 见测试方法, 除非特别指定)

项目	符号	测试条件	VDD	最小值	典型值	最大值	单位
传输延迟时间 Signal Input to Output	$t_{pd}$	$V_{IS}=V_{DD}$ , $R_L=200k$ , $CL=50pF$	5		15		ns
			10		10		ns
			15		7		ns
传输延迟时间 Address-to-Signal OUT (Channels ON or OFF)	$t_{pd}$	$CL=50pF$ , $R_L=10k$	5		100		ns
			10		80		ns
			15		50		ns

交流电学特性: (Continues,)

项目	符号	测试条件	VDD	最小值	典型值	最大值	单位
传输延迟时间 Inhibit-to-Signal OUT (Channel Turning ON)	t <sub>pd</sub>	C <sub>L</sub> =50pF, R <sub>L</sub> =1k	5		100		ns
			10		50		ns
			15		30		ns
传输延迟时间 Inhibit-to-Signal OUT (Channel Turning OFF)	t <sub>pd</sub>	C <sub>L</sub> =50pF, R <sub>L</sub> =10k	5		100		ns
			10		50		ns
			15		30		ns

测试方法

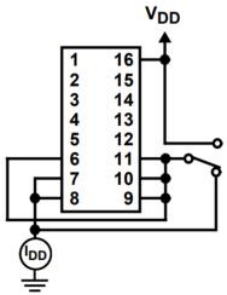

Fig.1 静态电流

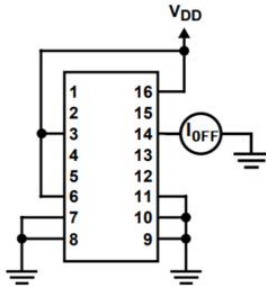

Fig.2 相邻通道关闭漏电流

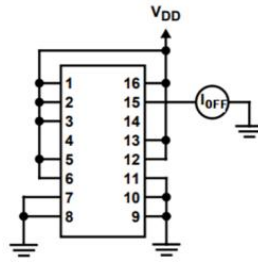

Fig.3 所有通道关闭漏电流

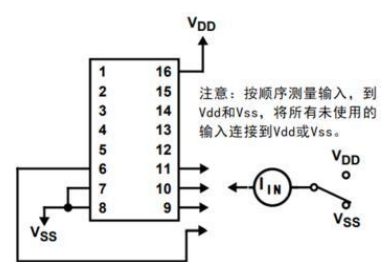

Fig.4 输入电流

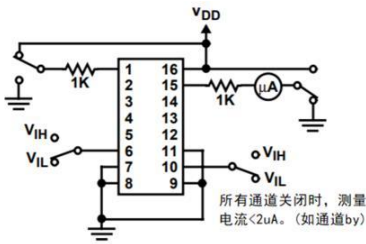

Fig.5 输入逻辑电平电压

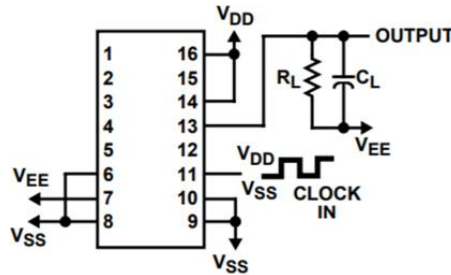

Fig.6 传播延迟-通道控制输入 to 开关输出

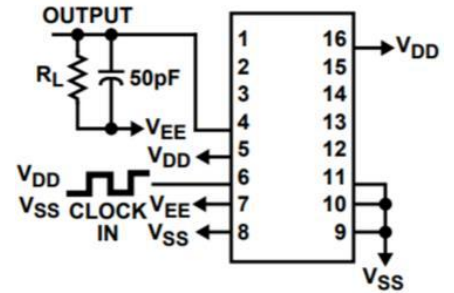

Fig.7 传播延迟-使能输入 to 开关输出

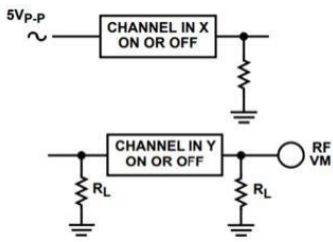

Fig.8 相邻通道之间信号串扰

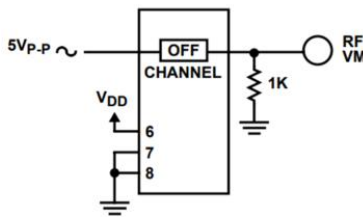

Fig.9 所有通道关闭信号串扰

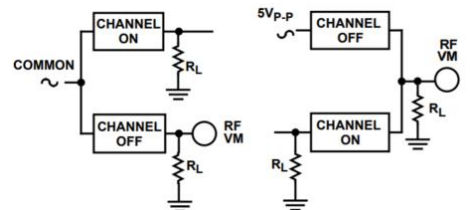
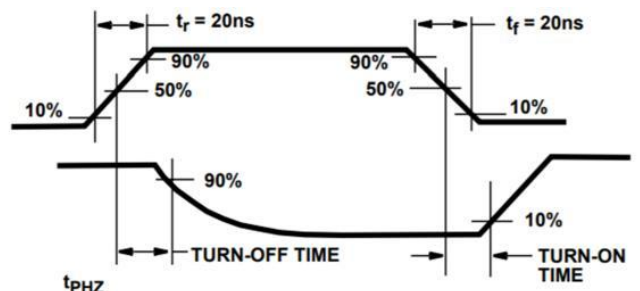
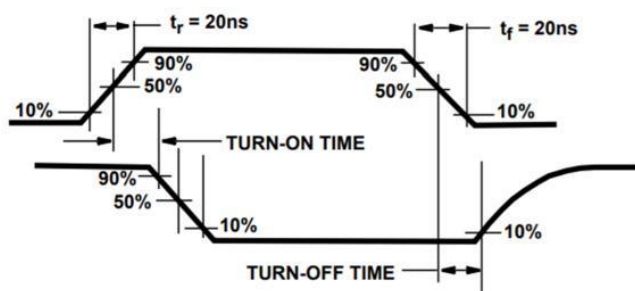

Fig.10 同一通道信号串扰

波形测量示意图



SOP-16 包装数据

单位：毫米 / 英寸

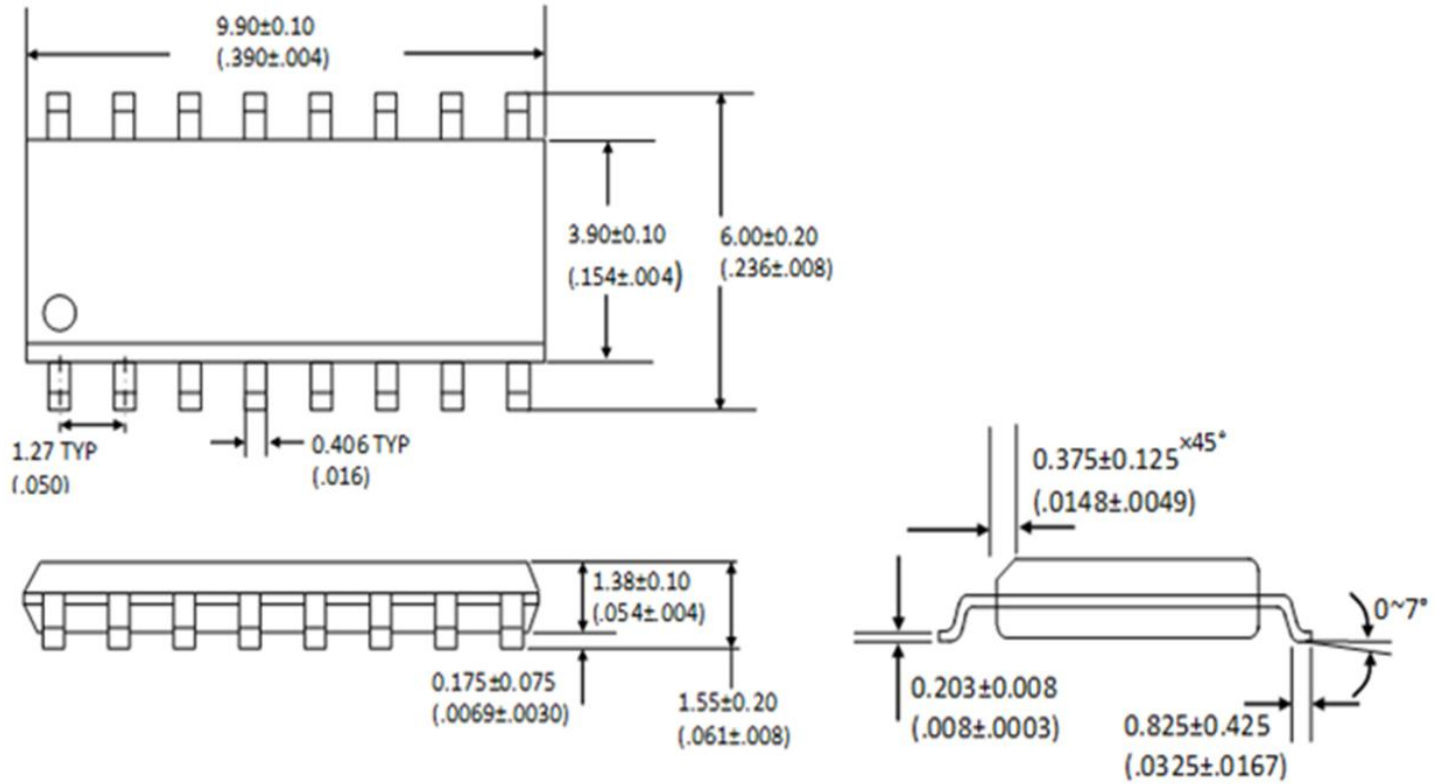

卷轴规格

P/N	PKG	QTY
74HC4053-MS	SOP-16	2500

## Attention

■ Any and all MSKSEMI Semiconductor products described or contained herein do not have specifications that can handle applications that require extremely high levels of reliability, such as life-support systems, aircraft's control systems, or other applications whose failure can be reasonably expected to result in serious physical and/or material damage. Consult with your MSKSEMI Semiconductor representative nearest you before using any MSKSEMI Semiconductor products described or contained herein in such applications.

■ MSKSEMI Semiconductor assumes no responsibility for equipment failures that result from using products at values that exceed, even momentarily, rated values (such as maximum ratings, operating condition ranges, or other parameters) listed in products specifications of any and all MSKSEMI Semiconductor products described or contained herein.

■ Specifications of any and all MSKSEMI Semiconductor products described or contained herein stipulate the performance, characteristics, and functions of the described products in the independent state, and are not guarantees of the performance, characteristics, and functions of the described products as mounted in the customer's products or equipment. To verify symptoms and states that cannot be evaluated in an independent device, the customer should always evaluate and test devices mounted in the customer's products or equipment.

■ MSKSEMI Semiconductor strives to supply high-quality high-reliability products. However, any and all semiconductor products fail with some probability. It is possible that these probabilistic failures could give rise to accidents or events that could endanger human lives, that could give rise to smoke or fire, or that could cause damage to other property. When designing equipment, adopt safety measures so that these kinds of accidents or events cannot occur. Such measures include but are not limited to protective circuits and error prevention circuits for safe design, redundant design, and structural design.

■ In the event that any or all MSKSEMI Semiconductor products (including technical data, services) described or contained herein are controlled under any of applicable local export control laws and regulations, such products must not be exported without obtaining the export license from the authorities concerned in accordance with the above law.

■ No part of this publication may be reproduced or transmitted in any form or by any means, electronic or mechanical, including photocopying and recording, or any information storage or retrieval system, or otherwise, without the prior written permission of MSKSEMI Semiconductor.

■ Information (including circuit diagrams and circuit parameters) herein is for example only ; it is not guaranteed for volume production. MSKSEMI Semiconductor believes information herein is accurate and reliable, but no guarantees are made or implied regarding its use or any infringement of intellectual property rights or other rights of third parties.

■ Any and all information described or contained herein are subject to change without notice due to product/technology improvement, etc. When designing equipment, refer to the "Delivery Specification" for the MSKSEMI Semiconductor product that you intend to use.