

MSKSEMI 美森科

SEMICONDUCTOR



ESD



TVS



TSS



MOV



GDT



PLED

SMF5.0(C)A-MS - SMF440(C)A-MS

Product specification



FEATURES

- For surface mounted applications in order to
- optimize board space.
- Low profile package
- Glass passivated junction
- Low inductance
- Plastic package has Underwriters Laboratory
Flammability

Mechanical Data

- Case : JEDEC SOD-123FL molded plastic body
- Terminals : Solderable per MIL-STD-750, Method 2026
- Polarity : Polarity symbol marking on body
- Mounting Position : Any
- Weight : 0.0007 ounce, 0.02 grams
- Marking : Date Code and Marking Code See Page 2

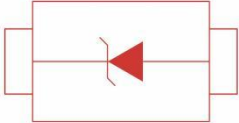
Reference News

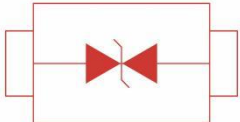
PACKAGE OUTLINE	PIN CONFIGURATION
	
Unipolar	
	
Bipolar	

Maximum Ratings and Electrical characteristics

Ratings at 25 °C ambient temperature unless otherwise specified.

Parameter	Symbol	Value	Unit
Peak Pulse Power Dissipation on TA=25°C (Note 1,2,5, Fig1)	P_{PPM}	200	W
Peak Forward Surge Current (Note 3)	I_{FSM} (UNI)	30	A
Peak Pulse Current on 10/1000 us waveform (Note 1) Fig 2	I_{PPM}	see Table 1	A
Steady State Power Dissipation (Note 4)	$P_{M(AV)}$	1.0	W
Operating Junction and Storage Range	T_J, T_{STG}	-55 to +150	°C
Typical Thermal Resistance	$R_{\theta JA}$	180	°C/W

NOTES

1. Non- repetitive current pulse per Fig 3 and derated above TA =25°C per Fig 2
2. Mounted on 5mm² copper pads to each terminal
3. 8 .3ms single half sinewave, or equivalent square wave duty cycle=4 pulses per minutes maximum
4. lead temperature at TL =75°C
5. Peak pulse powe . waveform is tp=10/1000us
6. A transient suppressor is selected according to the working peak reverse voltage(VRWM),
Which Should be equal to or greater than the DC or continuous peak operating voltage level

Characteristics at Ta = 25°C

Type		Marking		RMW	Breakdown Voltage		Test Current	Reverse Leakage	Max. C lamp Voltage	Peak P ulse Current
					VBR @ IT					
					Min	Max	IT	IR @ VRWM	VC @ IPP	IPP
Uni	BI	Uni	BI	V	V	V	mA	µA	V	A
SMF5.0A-MS	SMF5.0CA-MS	AE	NE	5	6.4	7	10	400	9.2	21.7
SMF6.0A-MS	SMF6.0CA-MS	AG	NG	6	6.67	7.37	10	400	10.3	19.4
SMF6.5A-MS	SMF6.5CA-MS	AK	NK	6.5	7.22	7.98	10	250	11.2	17.9
SMF7.0A-MS	SMF7.0CA-MS	AM	NM	7	7.78	8.6	10	100	12	16.7
SMF7.5A-MS	SMF7.5CA-MS	AP	NP	7.5	8.33	9.21	1	50	12.9	15.5
SMF8.0A-MS	SMF8.0CA-MS	AR	NR	8	8.89	9.83	1	25	13.6	14.7
SMF8.5A-MS	SMF8.5CA-MS	AT	NT	8.5	9.44	10.4	1	10	14.4	13.9
SMF9.0A-MS	SMF9.0CA-MS	AV	NV	9	10	11.1	1	5	15.4	13
SMF10A-MS	SMF10CA-MS	AX	NX	10	11.1	12.3	1	2.5	17	11.8
SMF11A-MS	SMF11CA-MS	AZ	NZ	11	12.2	13.5	1	2.5	18.2	11
SMF12A-MS	SMF12CA-MS	BE	OE	12	13.3	14.7	1	2.5	19.9	10.1
SMF13A-MS	SMF13CA-MS	BG	OG	13	14.4	15.9	1	1	21.5	9.3
SMF14A-MS	SMF14CA-MS	BK	OK	14	15.6	17.2	1	1	23.2	8.6
SMF15A-MS	SMF15CA-MS	BM	OM	15	16.7	18.5	1	1	24.4	8.2
SMF16A-MS	SMF16CA-MS	BP	OP	16	17.8	19.7	1	1	26	7.7
SMF17A-MS	SMF17CA-MS	BR	OR	17	18.9	20.9	1	1	27.6	7.2
SMF18A-MS	SMF18CA-MS	BT	OT	18	20	22.1	1	1	29.2	6.8
SMF20A-MS	SMF20CA-MS	BV	OV	20	22.2	24.5	1	1	32.4	6.2
SMF22A-MS	SMF22CA-MS	BX	OX	22	24.4	26.9	1	1	35.5	5.6
SMF24A-MS	SMF24CA-MS	BZ	OZ	24	26.7	29.5	1	1	38.9	5.1
SMF26A-MS	SMF26CA-MS	CE	PE	26	28.9	31.9	1	1	42.1	4.8
SMF28A-MS	SMF28CA-MS	CG	PG	28	31.1	34.4	1	1	45.4	4.4
SMF30A-MS	SMF30CA-MS	CK	PK	30	33.3	36.8	1	1	48.4	4.1
SMF33A-MS	SMF33CA-MS	CM	PM	33	36.7	40.6	1	1	53.3	3.8
SMF36A-MS	SMF36CA-MS	CP	PP	36	40	44.2	1	1	58.1	3.4
SMF40A-MS	SMF40CA-MS	CR	PR	40	44.4	49.1	1	1	64.5	3.1
SMF43A-MS	SMF43CA-MS	CT	PT	43	47.8	52.8	1	1	69.4	2.9
SMF45A-MS	SMF45CA-MS	CV	PV	45	50	55.3	1	1	72.7	2.8
SMF48A-MS	SMF48CA-MS	CX	PX	48	53.3	58.9	1	1	77.4	2.6
SMF51A-MS	SMF51CA-MS	CZ	PZ	51	56.7	62.7	1	1	82.4	2.4
SMF54A-MS	SMF54CA-MS	DE	PA	54	60	66.3	1	1	87.1	2.3
SMF58A-MS	SMF58CA-MS	DG	PC	58	64.4	71.2	1	1	93.6	2.1
SMF60A-MS	SMF60CA-MS	DK	CDK	60	66.7	73.7	1	1	96.8	1.8
SMF64A-MS	SMF64CA-MS	DM	CDM	64	71.1	78.6	1	1	103	1.7
SMF70A-MS	SMF70CA-MS	DP	CDP	70	77.8	86	1	1	113	1.5
SMF75A-MS	SMF75CA-MS	DR	CDR	75	83.3	92.1	1	1	121	1.4
SMF78A-MS	SMF78CA-MS	DT	CDT	78	86.7	95.8	1	1	126	1.4
SMF85A-MS	SMF85CA-MS	DV	CDV	85	94.4	104	1	1	137	1.3
SMF90A-MS	SMF90CA-MS	DX	CDX	90	100	111	1	1	146	1.2
SMF100A-MS	SMF100CA-MS	DZ	CDZ	100	111	123	1	1	162	1.1
SMF110A-MS	SMF110CA-MS	EE	CEE	110	122	135	1	1	177	1
SMF120A-MS	SMF120CA-MS	EG	CEG	120	133	147	1	1	193	0.9
SMF130A-MS	SMF130CA-MS	EK	CEK	130	144	159	1	1	209	0.8
SMF150A-MS	SMF150CA-MS	EM	CEM	150	167	185	1	1	243	0.7
SMF160A-MS	SMF160CA-MS	EP	CEP	160	178	197	1	1	259	0.7
SMF170A-MS	SMF170CA-MS	ER	CER	170	189	209	1	1	275	0.6
SMF180A-MS	SMF180CA-MS	ET	CET	180	201	222	1	1	292	0.5
SMF190A-MS	SMF190CA-MS	EV	CEV	190	211	232	1	1	308	0.5
SMF200A-MS	SMF200CA-MS	EX	CEX	200	224	247	1	1	324	0.5
SMF220A-MS	SMF220CA-MS	E22	CE22	220	246	272	1	1	356	0.5
SMF250A-MS	SMF250CA-MS	E25	CE25	250	279	309	1	1	405	0.5
SMF300A-MS	SMF300CA-MS	E30	CE30	300	335	371	1	1	486	0.45
SMF350A-MS	SMF350CA-MS	E35	CE35	350	391	432	1	1	567	0.4
SMF400A-MS	SMF400CA-MS	E40	CE40	400	447	494	1	1	648	0.35
SMF440A-MS	SMF440CA-MS	E44	CE44	440	492	543	1	1	713	0.3

Typical Characteristics

Fig.1 Peak Pulse Power Rating Curve



Fig.2 Forward Current Derating Curve



Fig.3 Pulse Waveform

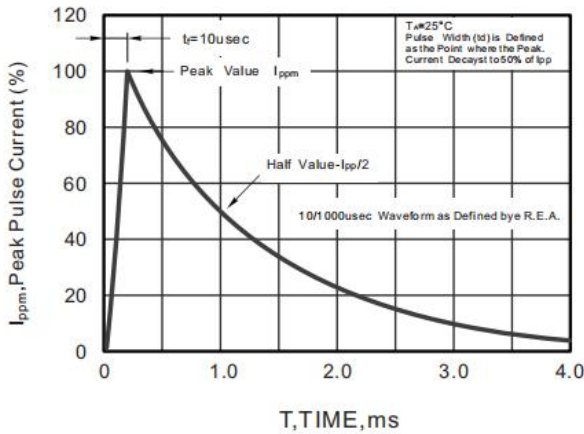
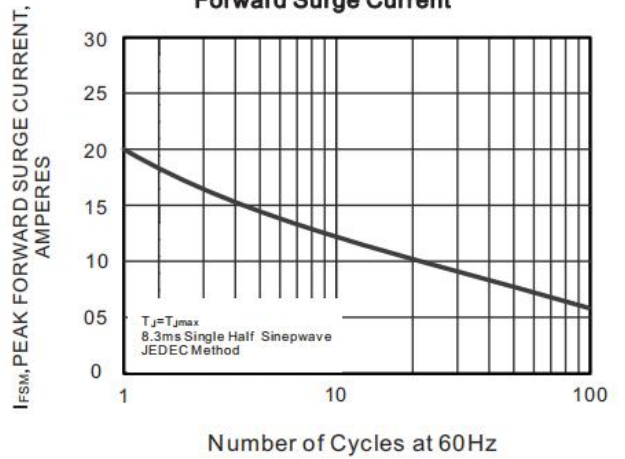

Fig.4 Maximum Non-Repetitive Peak Forward Surge Current



Packing information



Item	Symbol	Tolerance	SOD-123FL
Carrier width	A	0.1	2.1
Carrier length	B	0.1	4.0
Carrier depth	C	0.1	1.60
Sprocket hole	d	0.05	
7" Reel outside diameter	D	2.0	
7" Reel inner diameter	D1	min	
Feed hole diameter	D2	0.5	
Sprocket hole position	E	0.1	
Punch hole position	F	0.1	
Punch hole pitch	P	0.1	
Sprocket hole pitch	P0	0.1	
Embossment center	P1	0.1	
Overall tape thickness	T	0.1	
Tape width	W	0.3	
Reel width	W1	1.0	

Reel packing

PACKAGE	REEL SIZE	REEL (pcs)	COMPONENT SPACING (m/m)	BOX (pcs)	INNER BOX (m/m)	REEL DIA, (m/m)	CARTON SIZE (m/m)	CARTON (pcs)	APPROX. GROSS WEIGHT (kg)
SOD-123FL	7"	3,000	4.0	45,000	210*208*203	178	430*430*235	180,000	9.0

Suggested Pad Layout

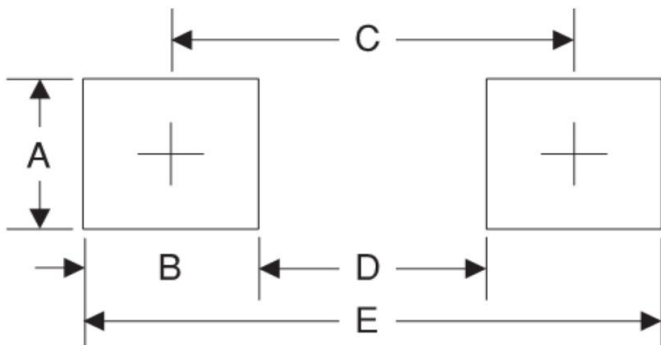

Symbol	Unit (mm)	Unit (inch)
A	1.2	0.047
B	1.2	0.047
C	3.2	0.126
D	2	0.079
E	4.4	0.173

Attention

- Any and all MSKSEMI Semiconductor products described or contained herein do not have specifications that can handle applications that require extremely high levels of reliability, such as life-support systems, aircraft's control systems, or other applications whose failure can be reasonably expected to result in serious physical and/or material damage. Consult with your MSKSEMI Semiconductor representative nearest you before using any MSKSEMI Semiconductor products described or contained herein in such applications.
- MSKSEMI Semiconductor assumes no responsibility for equipment failures that result from using products at values that exceed, even momentarily, rated values (such as maximum ratings, operating condition ranges, or other parameters) listed in products specifications of any and all MSKSEMI Semiconductor products described or contained herein.
- Specifications of any and all MSKSEMI Semiconductor products described or contained herein stipulate the performance, characteristics, and functions of the described products in the independent state, and are not guarantees of the performance, characteristics, and functions of the described products as mounted in the customer's products or equipment. To verify symptoms and states that cannot be evaluated in an independent device, the customer should always evaluate and test devices mounted in the customer's products or equipment.
- MSKSEMI Semiconductor strives to supply high-quality high-reliability products. However, any and all semiconductor products fail with some probability. It is possible that these probabilistic failures could give rise to accidents or events that could endanger human lives, that could give rise to smoke or fire, or that could cause damage to other property. When designing equipment, adopt safety measures so that these kinds of accidents or events cannot occur. Such measures include but are not limited to protective circuits and error prevention circuits for safe design, redundant design, and structural design.
- In the event that any or all MSKSEMI Semiconductor products (including technical data, services) described or contained herein are controlled under any of applicable local export control laws and regulations, such products must not be exported without obtaining the export license from the authorities concerned in accordance with the above law.
- No part of this publication may be reproduced or transmitted in any form or by any means, electronic or mechanical, including photocopying and recording, or any information storage or retrieval system, or otherwise, without the prior written permission of MSKSEMI Semiconductor.
- Information (including circuit diagrams and circuit parameters) herein is for example only ; it is not guaranteed for volume production. MSKSEMI Semiconductor believes information herein is accurate and reliable, but no guarantees are made or implied regarding its use or any infringement of intellectual property rights or other rights of third parties.
- Any and all information described or contained herein are subject to change without notice due to product/technology improvement, etc. When designing equipment, refer to the "Delivery Specification" for the MSKSEMI Semiconductor product that you intend to use.

单击下面可查看定价，库存，交付和生命周期等信息

[>>MSKSEMI\(美森科\)](#)