

MSKSEMI 美森科

SEMICONDUCTOR

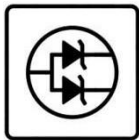

ESD



TVS



TSS

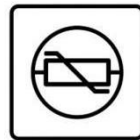

MOV



GDT



PLED

SSL34F-MS

Product specification

FEATURES

- Ideal for surface mount applications
- Easy pick and place
- Built-in strain relief
- Low forward voltage drop
- Ideal for surface mount applications
- Easy pick and place
- Built-in strain relief
- Low forward voltage drop

MACHANICAL DATA

- Case: Molded plastic
- Epoxy: UL 94V-0 rate flame retardant
- Metallurgically bonded construction
- Polarity: Color band denotes cathode end
- Mounting position: Any



- **VOLTAGE RANGE**

40 Volts

- **CURRENT**

3.0 Ampere

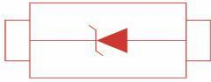
Reference News

PACKAGE OUTLINE	PIN CONFIGURATION	Marking
		
<p>SMAF</p>		

MAXIMUM RATINGS AND ELECTRICAL CHARACTERISTICS

Rating 25 C ambient temperature unless otherwise specified.

Single phase half wave, 60Hz, resistive or inductive load.

For capacitive load, derate current by 20%.

TYPE NUMBER	SSL34F-MS	UNITS
Maximum Recurrent Peak Reverse Voltage	40	V
Maximum RMS Voltage	28	V
Maximum DC Blocking Voltage	40	V
Maximum Average Forward Rectified Current See Fig. 1	3.0	A
Peak Forward Surge Current, 8.3 ms single half sine-wave superimposed on rated load (JEDEC method)	50	A
Maximum Instantaneous Forward Voltage at 2.0A	0.46	V
Maximum DC Reverse Current at Rated DC Blocking Voltage	Ta=25 C 0.2 Ta=125°C 30	mA mA
Typical Junction Capacitance (Note1)	240	pF
Typical Thermal Resistance R _{JA} (Note 2)	88	C/W
Operating Temperature Range T _J	-55 to +125	°C
Storage Temperature Range T _{STG}	-55 to +150	°C

NOTES:

1. Measured at 1MHz and applied reverse voltage of 4.0V D.C.
2. P.C.B. mounted with 0.2" x 0.2" (5.0 mm x 5.0 mm) copper pad areas

RATING AND CHARACTERISTIC CURVES (SSL34F-MS)

FIG.1-FORWARD CURRENT DERATING CURVE

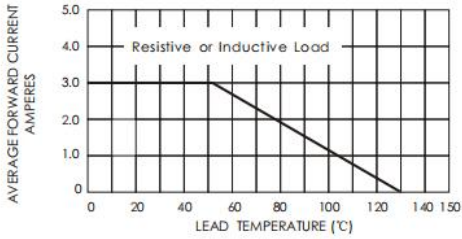

FIG.2-MAXIMUM NON-REPETITIVE PEAK FORWARD SURGE CURRENT

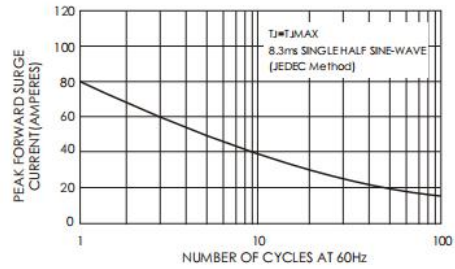

FIG.3-TYPICAL INSTANTANEOUS FORWARD CHARACTERISTICS

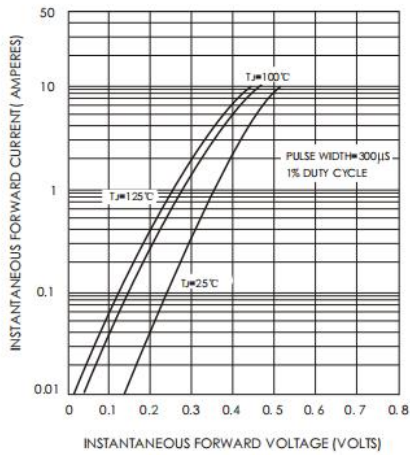

FIG.4-TYPICAL REVERSE CHARACTERISTICS

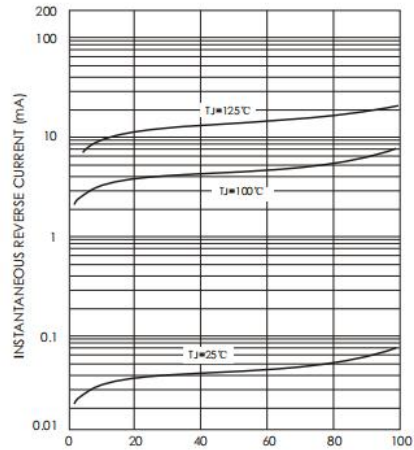
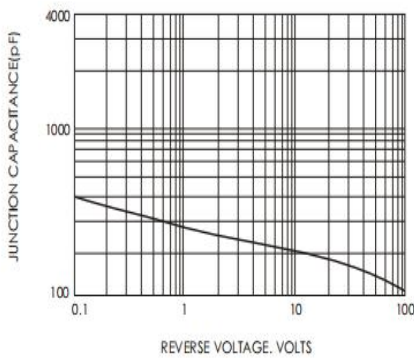
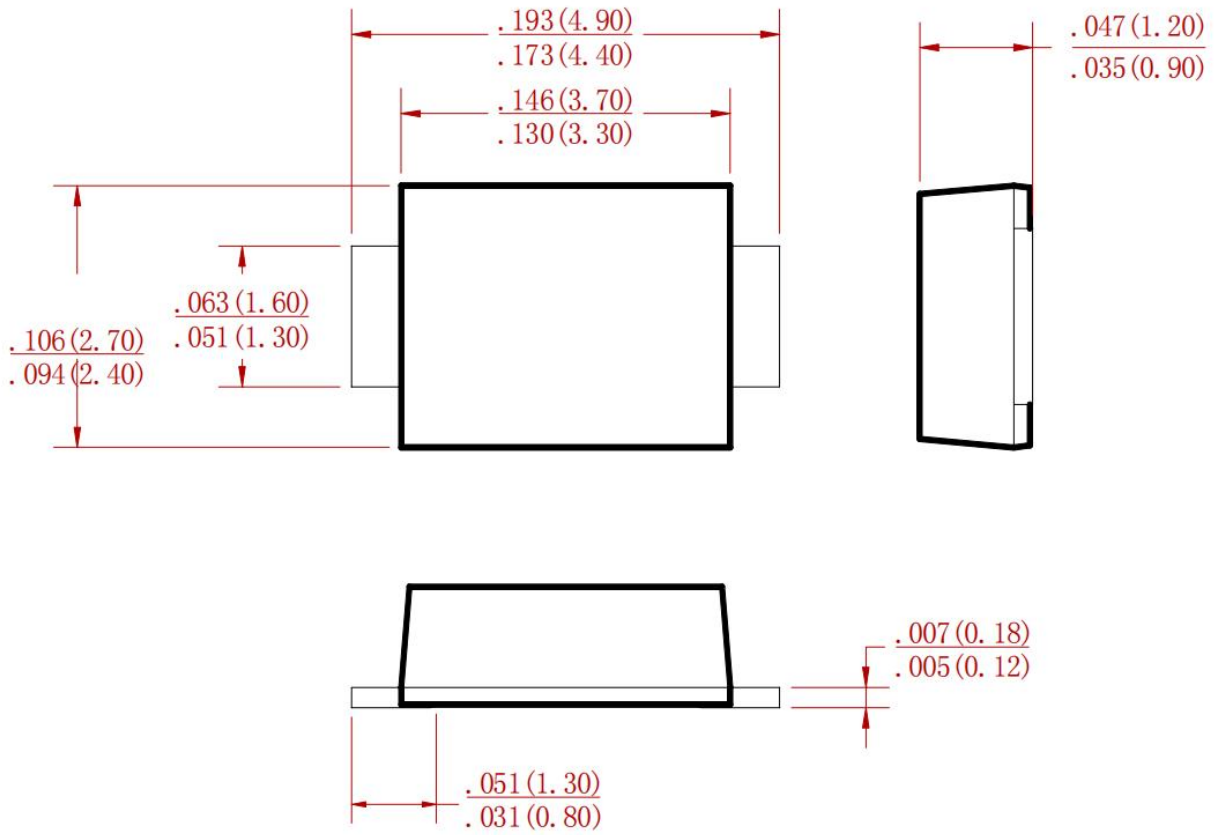

FIG.5-TYPICAL JUNCTION CAPACITANCE



PACKAGE MECHANICAL DATA



Dimensions in inches and (millimeters)

REEL SPECIFICATION

P/N	PKG	QTY
SSL34F-MS	SMAF	3000

Attention

- Any and all MSKSEMI Semiconductor products described or contained herein do not have specifications that can handle applications that require extremely high levels of reliability, such as life-support systems, aircraft's control systems, or other applications whose failure can be reasonably expected to result in serious physical and/or material damage. Consult with your MSKSEMI Semiconductor representative nearest you before using any MSKSEMI Semiconductor products described or contained herein in such applications.
- MSKSEMI Semiconductor assumes no responsibility for equipment failures that result from using products at values that exceed, even momentarily, rated values (such as maximum ratings, operating condition ranges, or other parameters) listed in products specifications of any and all MSKSEMI Semiconductor products described or contained herein.
- Specifications of any and all MSKSEMI Semiconductor products described or contained herein stipulate the performance, characteristics, and functions of the described products in the independent state, and are not guarantees of the performance, characteristics, and functions of the described products as mounted in the customer's products or equipment. To verify symptoms and states that cannot be evaluated in an independent device, the customer should always evaluate and test devices mounted in the customer's products or equipment.
- MSKSEMI Semiconductor strives to supply high-quality high-reliability products. However, any and all semiconductor products fail with some probability. It is possible that these probabilistic failures could give rise to accidents or events that could endanger human lives, that could give rise to smoke or fire, or that could cause damage to other property. When designing equipment, adopt safety measures so that these kinds of accidents or events cannot occur. Such measures include but are not limited to protective circuits and error prevention circuits for safe design, redundant design, and structural design.
- In the event that any or all MSKSEMI Semiconductor products (including technical data, services) described or contained herein are controlled under any of applicable local export control laws and regulations, such products must not be exported without obtaining the export license from the authorities concerned in accordance with the above law.
- No part of this publication may be reproduced or transmitted in any form or by any means, electronic or mechanical, including photocopying and recording, or any information storage or retrieval system, or otherwise, without the prior written permission of MSKSEMI Semiconductor.
- Information (including circuit diagrams and circuit parameters) herein is for example only ; it is not guaranteed for volume production. MSKSEMI Semiconductor believes information herein is accurate and reliable, but no guarantees are made or implied regarding its use or any infringements of intellectual property rights or other rights of third parties.
- Any and all information described or contained herein are subject to change without notice due to product/technology improvement, etc. When designing equipment, refer to the "Delivery Specification" for the MSKSEMI Semiconductor product that you intend to use.

单击下面可查看定价，库存，交付和生命周期等信息

[>>MSKSEMI\(美森科\)](#)