

MSKSEMI 美森科

SEMICONDUCTOR



ESD



TVS



TSS



MOV



GDT



PLED

LMV321

Product specification

DESCRIPTION

The LMV321 is single low voltage (2.7V to 5.5V) operational amplifier which has rail-to-rail output swing capability. The input common-mode voltage range includes ground. The chip exhibits excellent speed-power ratio, achieving 1MHz of bandwidth and 1V/ μ s of slew rate with low supply current.

The LMV321 S is built with BiCMOS process. It has bipolar input and output stages for improved noise performance, low input offset and higher output current drive.

The LMV321 is available in the package of SC-70-5, which is approximately half the size of SOT-23-5. The small package saves space on pc boards, and enables the design of small portable electronic devices. It also allows the designer to place the device closer to the signal source to reduce noise pickup and increase signal integrity.

The LMV321 is also available in standard SOT-23-5 package.



FEATURES (For $V_{CC}=5V$ and $V_{EE}=0V$, Typical unless Otherwise Noted)

- Guaranteed 2.7V to 5.5V Performance
- No Crossover Distortion
- Gain-Bandwidth Product 1MHz
- Industrial Temperature Range: $-40^{\circ}C$ to $+85^{\circ}C$
- Low Supply Current: 130 μ A
- Rail-to-Rail Output Swing under 10k Ω Load:
- V_{OH} up to $V_{CC}-10mV$
- V_{OL} near to $V_{EE}+65mV$
- V_{CM} : -0.1V to $V_{CC}-0.8V$

Applications

- Active Filters
- Low Power, Low Voltage Applications
- General Purpose Portable Devices
- Cellular Phone, Cordless Phone
- Battery-Powered Systems

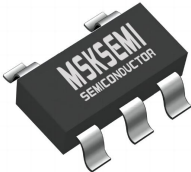
Reference News

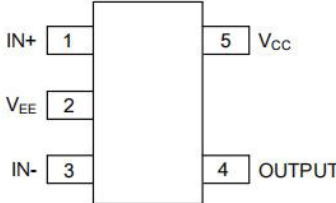
PACKAGE OUTLINE		PIN CONFIGURATION	Marking	
			RC1F	R3F
SOT-23-5	SC70-5	IDBV/IDCK Package (SC-70-5/SOT-23-5)	SOT-23-5	SC70-5

Ordering Information

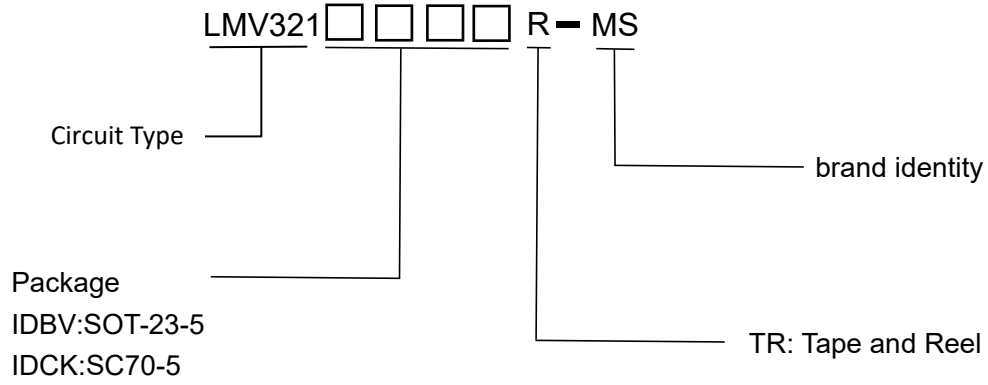

Package	Temperature Range	Part Number		Marking ID		Packing Type
		Lead Free	Green	Lead Free	Green	
SC-70-5	-40 to 85°C		LMV321IDCKR-MS		R3F	Tape & Reel
SOT-23-5			LMV321IDBVR-MS		RC1F	Tape & Reel

Functional Block Diagram

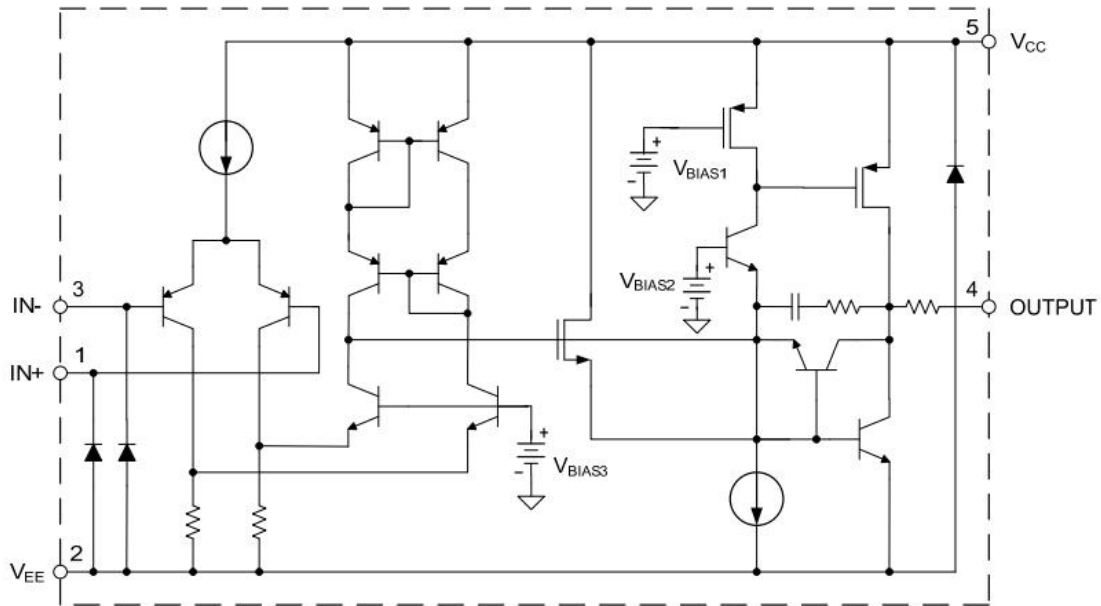

Absolute Maximum Ratings (Note 1)

Symbol	Parameter	Rating	Unit
VCC	Power Supply Voltage	6	V
TJ	Operation Junction Temperature	150	°C
TSTG	Storage Temperature Range	-65 to 150	°C
TLEAD	Lead Temperature (Soldering, 10 Seconds)	260	°C
	ESD (Machine Model)	200	V
	ESD (Human Body Model)	2000	V

Note 1: Stresses greater than those listed under "Absolute Maximum Ratings" may cause permanent damage to the device. These are stress ratings only, and functional operation of the device at these or any other conditions beyond those indicated under "Recommended Operating Conditions" is not implied. Exposure to "Absolute Maximum Ratings" for extended periods may affect device reliability.

Recommended Operating Conditions

Symbol	Parameter	Min	Max	Unit
VCC	Supply Voltage	2.7	5.5	V
TA	Ambient Operating Temperature Range	-40	85	°C

Electrical Characteristics

LMV321-2.7V Electrical Characteristic(Asll limits are guaranteed for TA=25°C, VCC=2.7V, VEE=0V, VCM=1.0V, VO=VCC/2 and RL>1MΩ , limits in bold types are guaranteed for TA=-40°C to 85°C, unless otherwise specified. Note 2)

Symbol	Parameter	Conditions	Min	Typ	Max	Unit
VIO	Input Offset Voltage			1.7	7	mV
					9	
IB	Input Bias Current			11	250	nA
					500	
IIO	Input Offset Current			5	50	nA
					150	
VCM	Input Common Mode Voltage Range	for CMRR≥50dB	-0.1		1.9	V
ICC	Supply Current	VO=VCC/2, AVCL=1, no load		80	170	μA
					270	
CMRR	Common Mode Rejection Ratio	0≤VCM≤ 1.7V	50	65		dB
PSRR	Power Supply Rejection Ratio	2.7V≤VCC≤5V, VO=1V	50	60		dB
ISOURCE	Output Short Circuit Current	VO=0V	5	20		mA
ISINK		VO=2.7V	10	30		mA
VOH	Output Voltage Swing	RL=10kΩ to 1.35V	2.60	2.69		V
VOL				60	180	
GBWP	Gain Bandwidth Product	CL=200pF		1		MHz
OM	Phase Margin			60		Deg
GM	Gain Margin			10		dB

Note 2: Limits over the full temperature are guaranteed by design, but not tested in production.

Electrical Characteristics (Cont.)

LMV321-5V Electrical Characteristics (All limits are guaranteed for TA=25°C, VCC=5V, VEE=0V, VCM=2.0V, VO=VCC/2 and RL>1MΩ, limits in bold types are guaranteed for TA=-40°C to 85°C, unless otherwise specified. Note 2)

Symbol	Parameter	Conditions	Min	Typ	Max	Unit
VIO	Input Offset Voltage			1.7	7	mV
					9	
IB	Input Bias Current			11	250	nA
					500	
IIO	Input Offset Current			5	50	nA
					150	
VCM	Input Common Mode Voltage Range	for CMRR≥50dB	-0.1		4.2	V
ICC	Supply Current	VO=VCC/2, AVCL=1, no load		130	250	μA
					350	
GV	Large Signal Voltage Gain	RL=2kΩ	84	100		dB
			80			
CMRR	Common Mode Rejection Ratio	0≤VCM≤4V	50	65		dB
PSRR	Power Supply Rejection Ratio	2.7V≤VCC≤5V, VO=1V, VCM=1V	50	60		dB
ISOURCE	Output Short Circuit Current	VO=0V	5	60		mA
ISINK		VO=5V	10	160		mA
VOH	Output Voltage Swing	RL=2kΩ to 2.5V	4.7	4.96		V
			4.6			
		RL=10kΩ to 2.5V	4.9	4.99		
			4.8			
VOL	Output Voltage Swing	RL=2kΩ to 2.5V		120	300	mV
					400	
		RL=10kΩ to 2.5V		65	180	
					280	
SR	Slew Rate			1		V/μS
GBWP	Gain Bandwidth Product	CL=200pF		1		MHz
OM	Phase Margin			60		Deg
GM	Gain Margin			10		dB

Note 2: Limits over the full temperature are guaranteed by design, but not tested in production.

Performance Characteristics

Supply Current vs. Supply Voltage

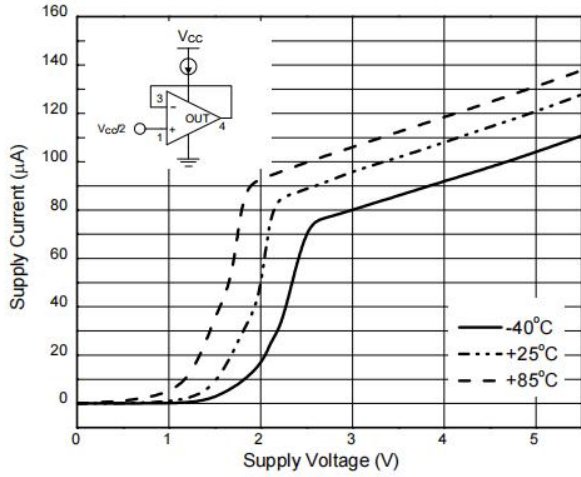

Slew Rate vs. Supply Voltage

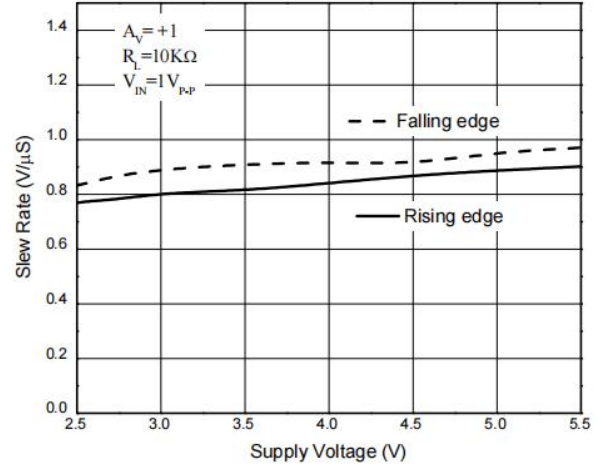

Output Source Current vs. Supply Voltage

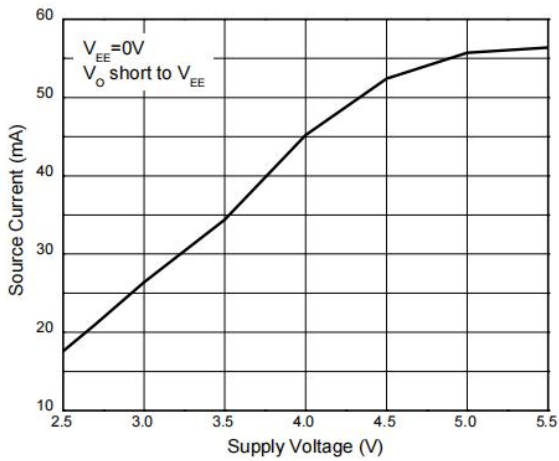

Output Sink Current vs. Supply Voltage

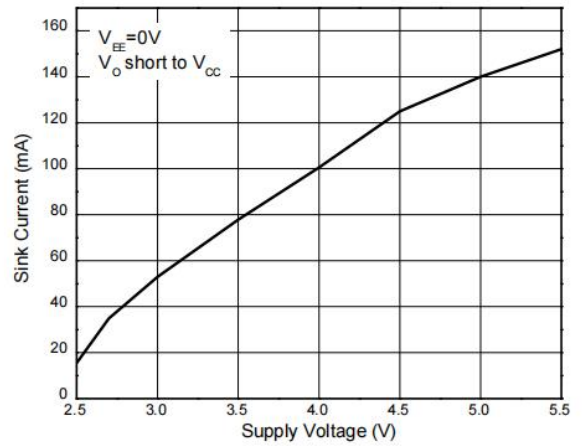

Short Circuit Current I_{SINK} vs. Temperature

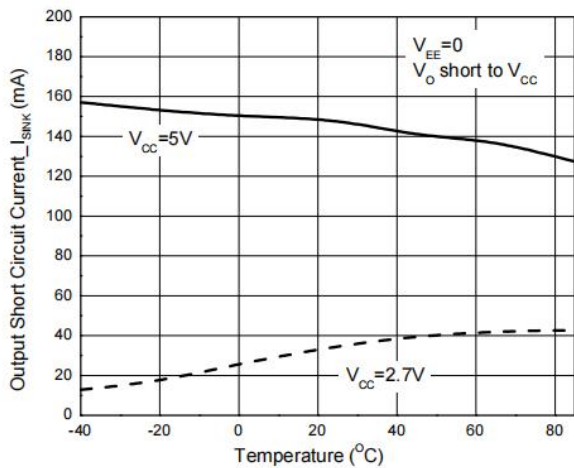

Short Circuit Current I_{SOURCE} vs. Temperature

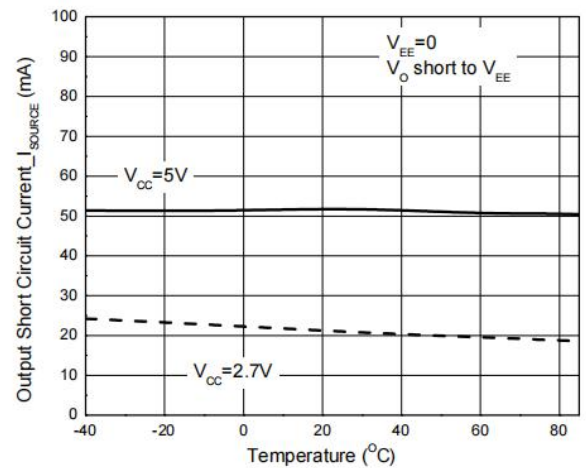

Performance Characteristics (Cont.)

Output Voltage vs. Source Current

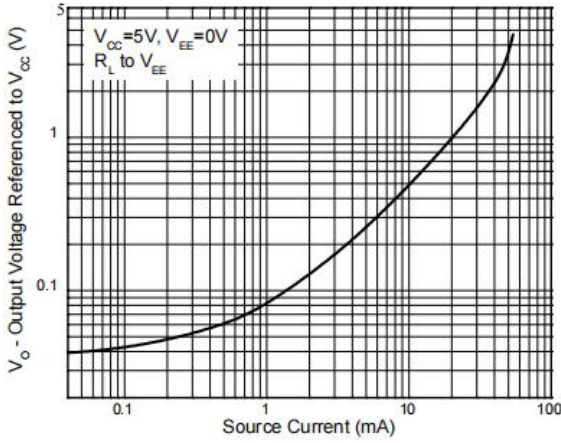

Output Voltage vs. Sink Current

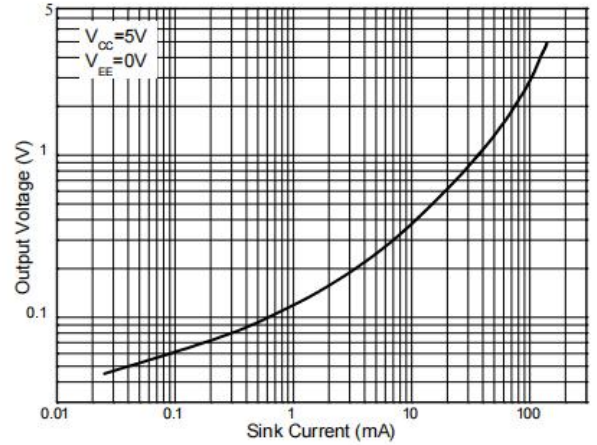

Output Voltage Swing vs. Supply Voltage

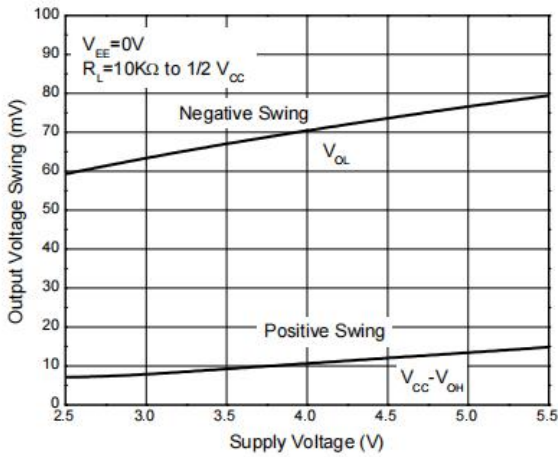

Output Voltage Swing vs. Temperature

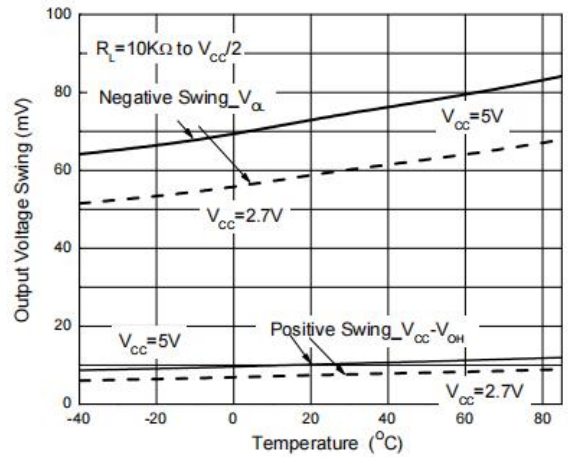

Gain and Phase vs. Frequency and Resistive Load

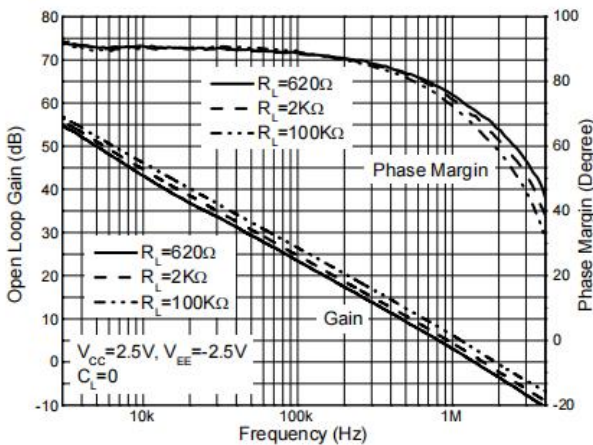

Gain and Phase vs. Frequency and Capacitive Load

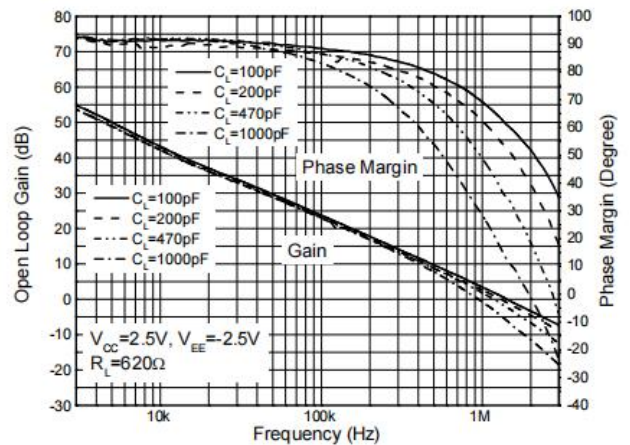

Performance Characteristics (Cont.)

Gain and Phase vs. Frequency and Capacitive Load

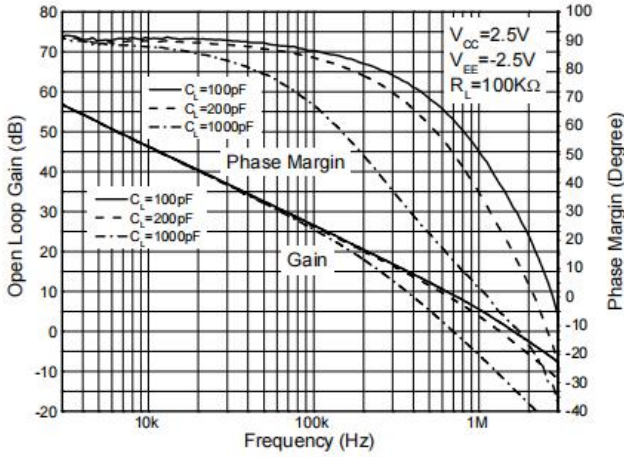

Non-Inverting Input Small Signal Pulse Response

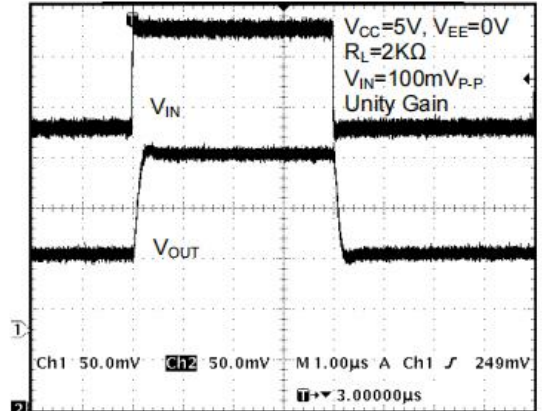

Non-Inverting Input Large Signal Pulse Response

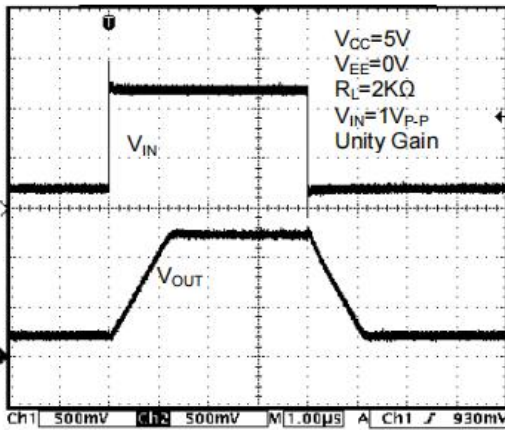

Output with Excessive Capacitive Load

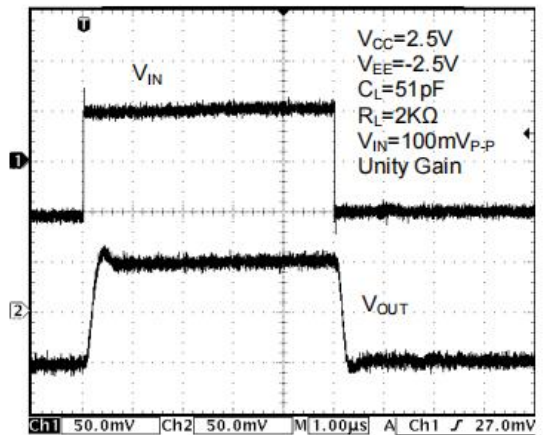

Output with Excessive Capacitive Load

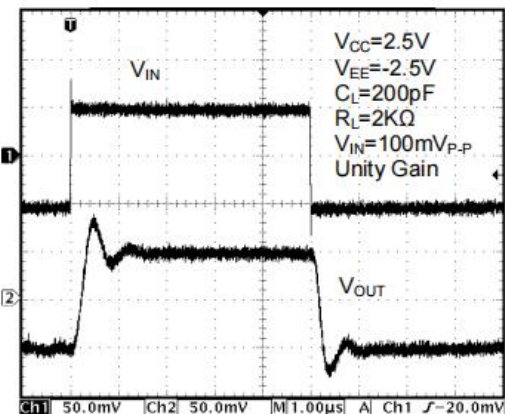

THD+N vs. Frequency

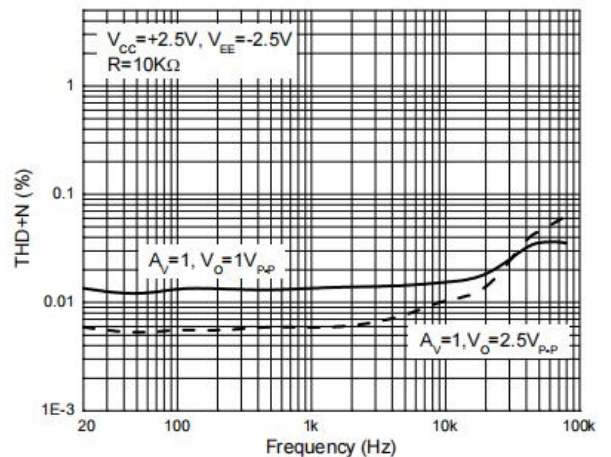

Package Outline Dimensions (All dimensions in mm(inch).)

SC-70-5

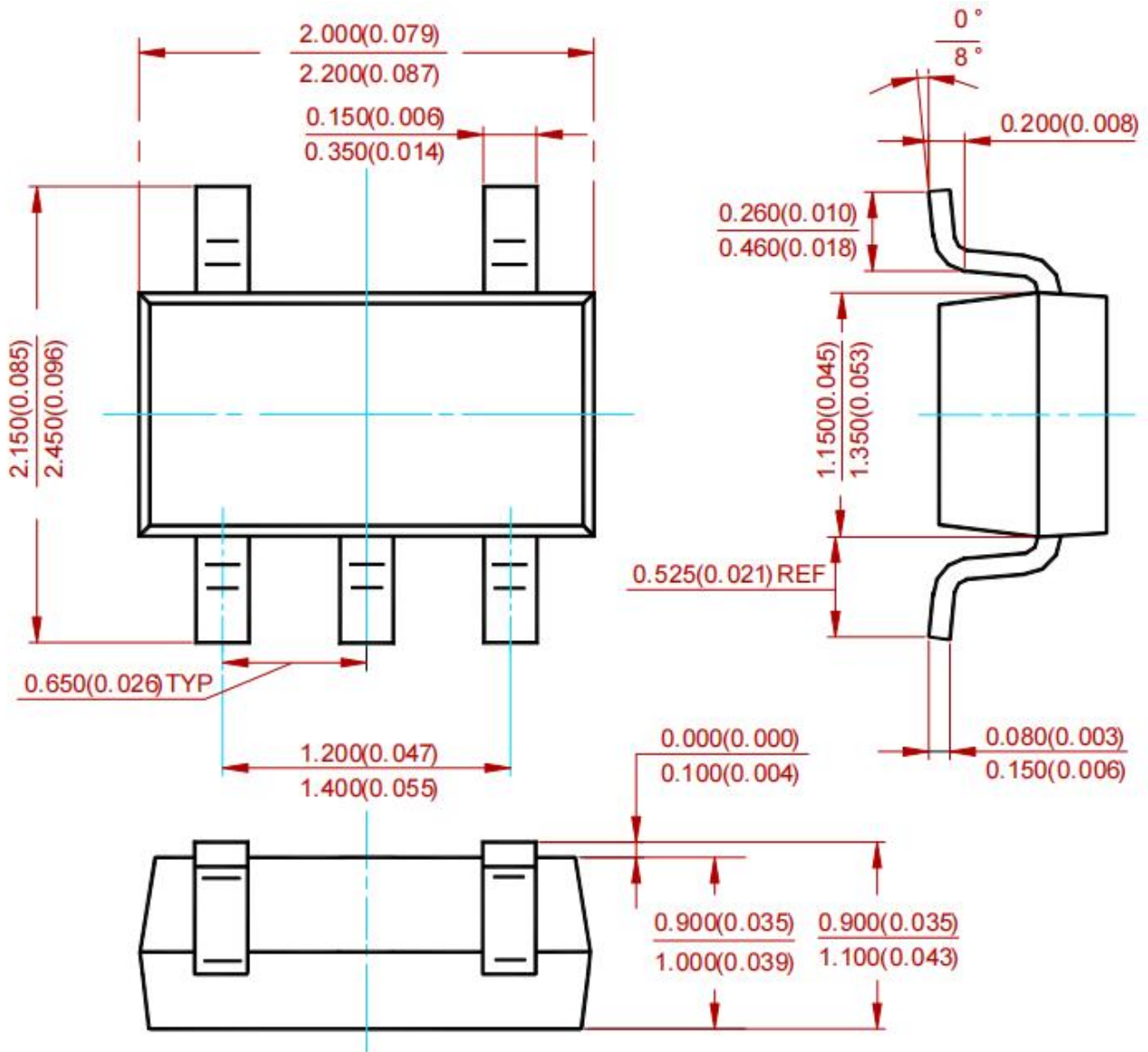

Suggested Pad Layout

SC-70-5

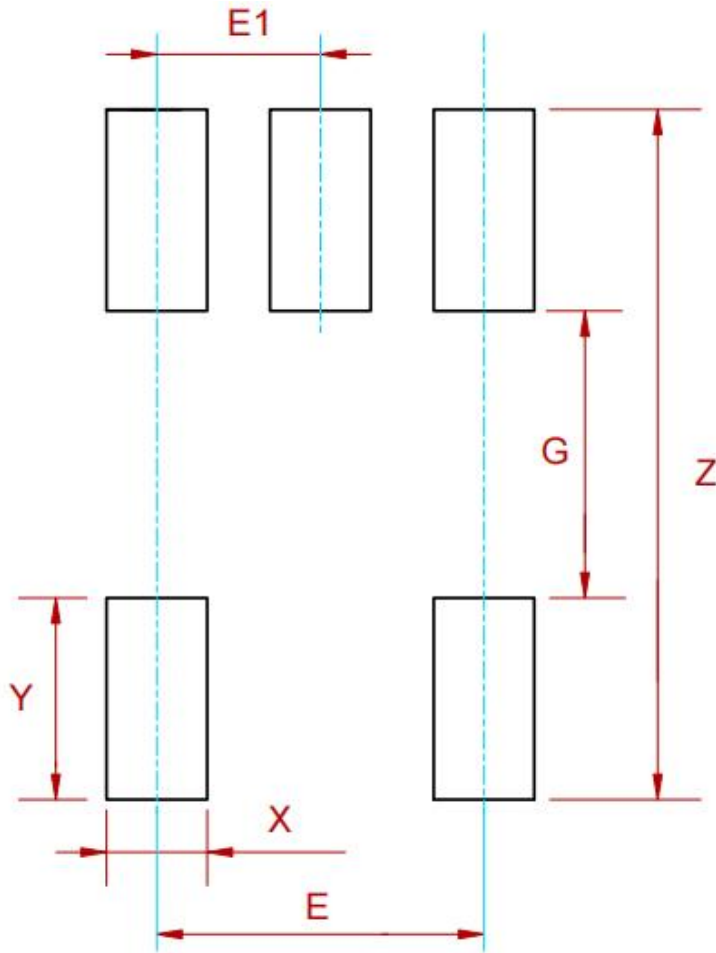

Dimensions	Z (mm)/(inch)	G (mm)/(inch)	X (mm)/(inch)	Y (mm)/(inch)	E (mm)/(inch)	E1 (mm)/(inch)
Value	2.740/0.108	1.140/0.045	0.400/0.016	0.800/0.031	1.300/0.051	0.650/0.026

Package Outline Dimensions (All dimensions in mm(inch).)

SOT-23-5

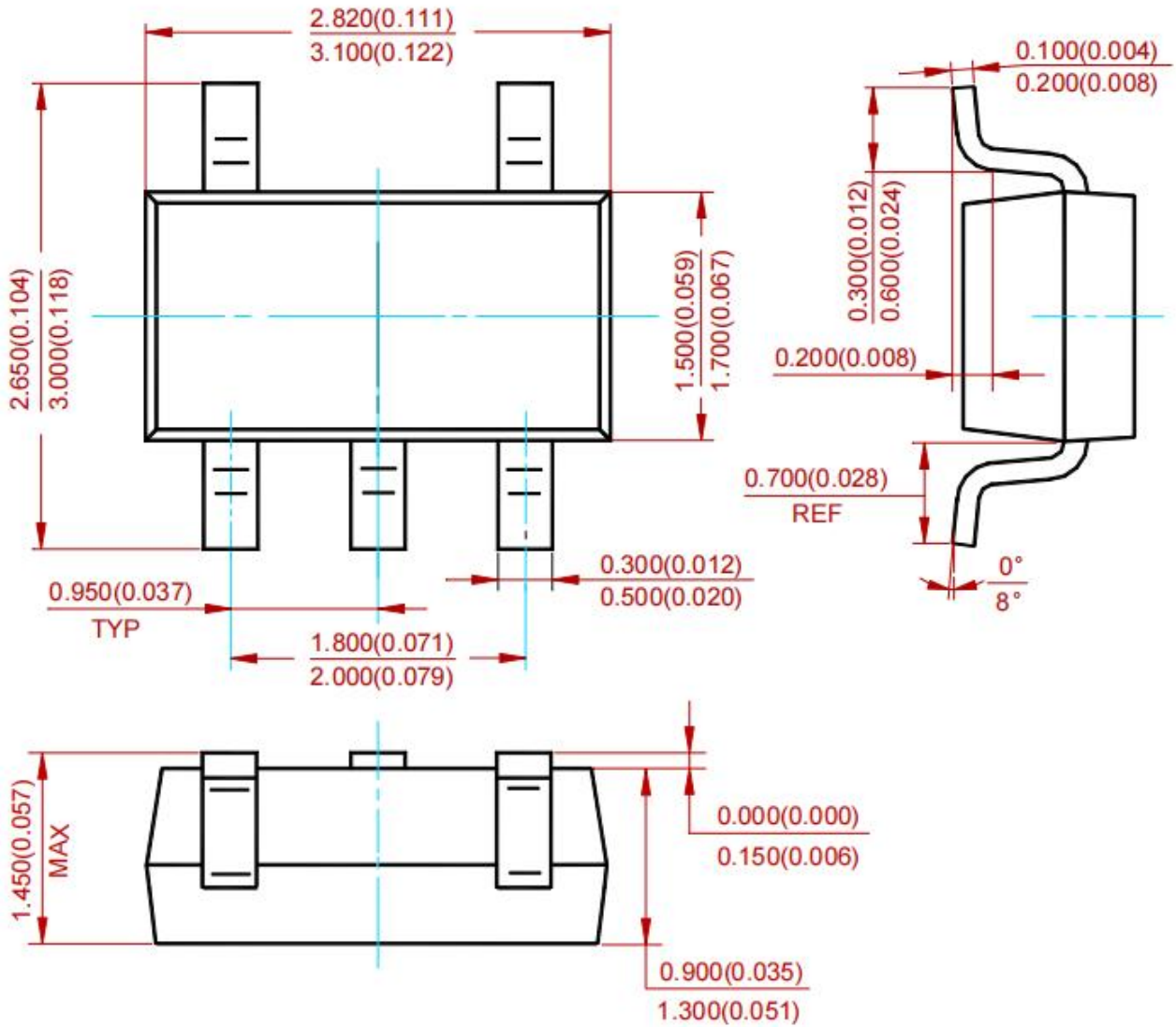

Suggested Pad Layout

SOT-23-5

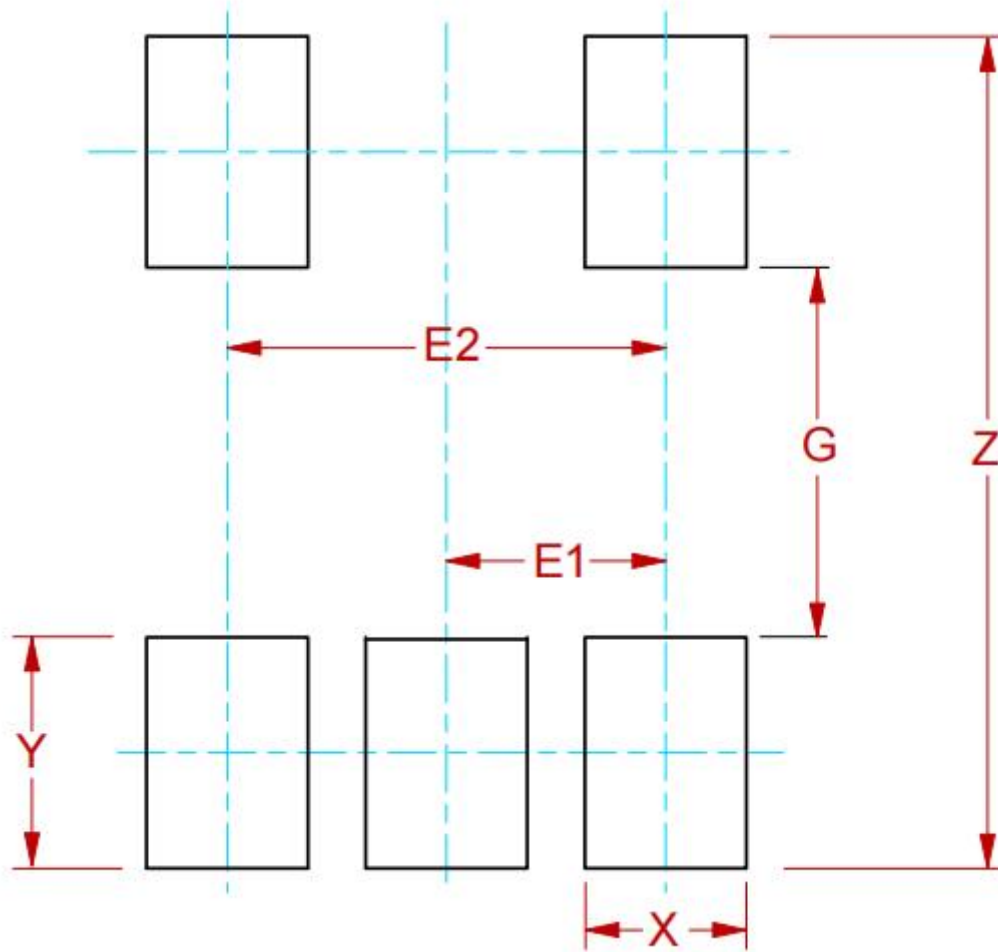

Dimensions	Z (mm)/(inch)	G (mm)/(inch)	X (mm)/(inch)	Y (mm)/(inch)	E1 (mm)/(inch)	E2 (mm)/(inch)
Value	3.600/0.142	1.600/0.063	0.700/0.028	1.000/0.039	0.950/0.037	1.900/0.075

Attention

- Any and all MSKSEMI Semiconductor products described or contained herein do not have specifications that can handle applications that require extremely high levels of reliability, such as life-support systems, aircraft's control systems, or other applications whose failure can be reasonably expected to result in serious physical and/or material damage. Consult with your MSKSEMI Semiconductor representative nearest you before using any MSKSEMI Semiconductor products described or contained herein in such applications.
- MSKSEMI Semiconductor assumes no responsibility for equipment failures that result from using products at values that exceed, even momentarily, rated values (such as maximum ratings, operating condition ranges, or other parameters) listed in products specifications of any and all MSKSEMI Semiconductor products described or contained herein.
- Specifications of any and all MSKSEMI Semiconductor products described or contained herein stipulate the performance, characteristics, and functions of the described products in the independent state, and are not guarantees of the performance, characteristics, and functions of the described products as mounted in the customer's products or equipment. To verify symptoms and states that cannot be evaluated in an independent device, the customer should always evaluate and test devices mounted in the customer's products or equipment.
- MSKSEMI Semiconductor strives to supply high-quality high-reliability products. However, any and all semiconductor products fail with some probability. It is possible that these probabilistic failures could give rise to accidents or events that could endanger human lives, that could give rise to smoke or fire, or that could cause damage to other property. When designing equipment, adopt safety measures so that these kinds of accidents or events cannot occur. Such measures include but are not limited to protective circuits and error prevention circuits for safe design, redundant design, and structural design.
- In the event that any or all MSKSEMI Semiconductor products (including technical data, services) described or contained herein are controlled under any of applicable local export control laws and regulations, such products must not be exported without obtaining the export license from the authorities concerned in accordance with the above law.
- No part of this publication may be reproduced or transmitted in any form or by any means, electronic or mechanical, including photocopying and recording, or any information storage or retrieval system, or otherwise, without the prior written permission of MSKSEMI Semiconductor.
- Information (including circuit diagrams and circuit parameters) herein is for example only ; it is not guaranteed for volume production. MSKSEMI Semiconductor believes information herein is accurate and reliable, but no guarantees are made or implied regarding its use or any infringement of intellectual property rights or other rights of third parties.
- Any and all information described or contained herein are subject to change without notice due to product/technology improvement, etc. When designing equipment, refer to the "Delivery Specification" for the MSKSEMI Semiconductor product that you intend to use.

单击下面可查看定价，库存，交付和生命周期等信息

[>>MSKSEMI\(美森科\)](#)