

MSKSEMI

SEMICONDUCTOR



ESD



TVS



TSS



MOV



GDT



PLED

Product data sheet

www.msksemi.com

DIGITAL TRANSISTOR (NPN)

FEATURES

- Built-in bias resistors enable the configuration of an inverter circuit without connecting external input resistors(see equivalent circuit)
- The bias resistors consist of thin-film resistors with complete isolation to allow negative biasing of the input.They also have the advantage of almost completely eliminating parasitic effects
- Only the on/off conditions need to be set for operation, making device design easy

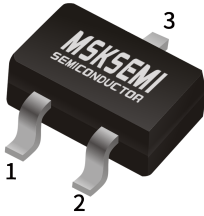

• **Equivalent Circuit**

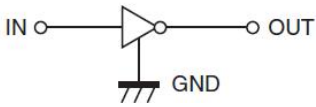
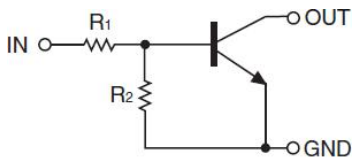

• **PIN**

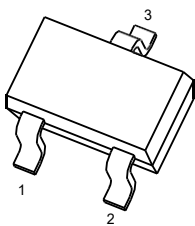

- 1. IN
- 2. GND
- 3. OUT

DTC143EUA-MS
SOT-323

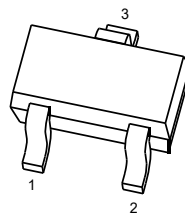

- 1. IN
- 2. GND
- 3. OUT

DTC143EE-MS
SOT-523

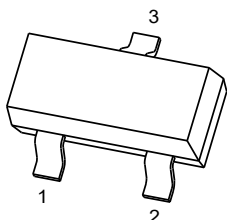

- 1. IN
- 2. GND
- 3. OUT

DTC143ECA-MS
SOT-23

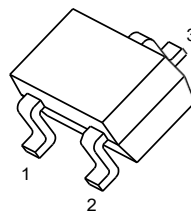

- 1. IN
- 2. GND
- 3. OUT

DTC143EKA-MS
SOT-23-3L

MAXIMUM RATINGS(Ta=25°C unless otherwise noted)

Symbol	Parameter	DTC143					Unit
			EE-MS	EUA-MS	ECA-MS	EKA-MS	
V _{CC}	Supply Voltage	50					V
V _{IN}	Input Voltage	-10~+30					V
I _o	Output Current	100					mA
P _D	Power Dissipation		150	200	200	200	mW
T _j	Junction Temperature	150					°C
T _{stg}	Storage Temperature	-55~+150					°C

ELECTRICAL CHARACTERISTICS (Ta=25°C unless otherwise specified)

Parameter	Symbol	Conditions	Min	Typ	Max	Unit
Input voltage	V _{I(off)}	V _{CC} =5V, I _o =100μA	0.5			V
	V _{I(on)}	V _O =0.3V, I _o =20mA			3	V
Output voltage	V _{O(on)}	I _o /I _i =10mA/0.5mA			0.3	V
Input current	I _i	V _i =5V			1.8	mA
Output current	I _{O(off)}	V _{CC} =50V, V _i =0			0.5	μA
DC current gain	G _i	V _O =5V, I _o =10mA	20			
Input resistance	R ₁		3.29	4.7	6.11	kΩ
Resistance ratio	R ₂ /R ₁		0.8	1	1.2	
Transition frequency	f _T	V _O =10V, I _o =5mA, f=100MHz		250		MHz

Typical Characteristics

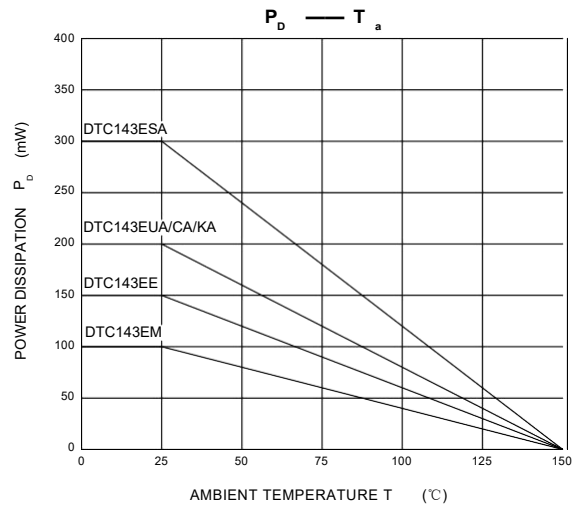
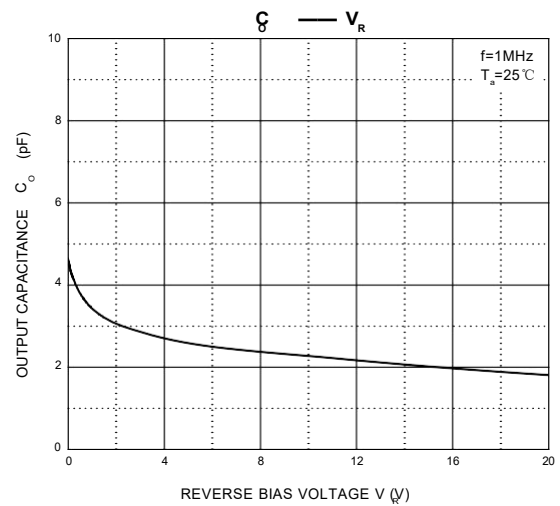
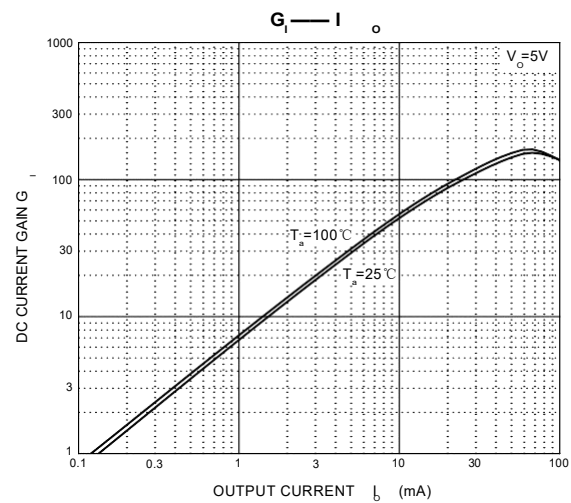
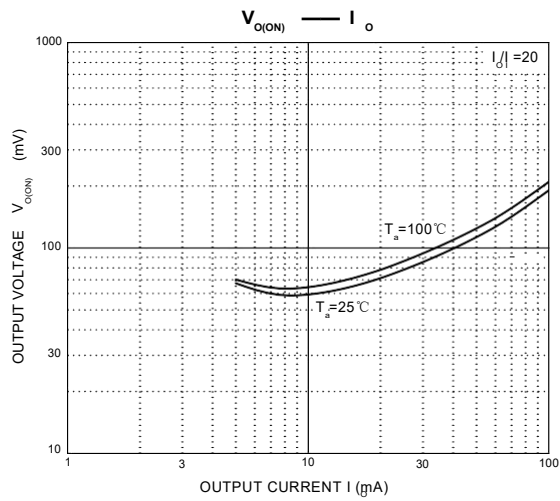
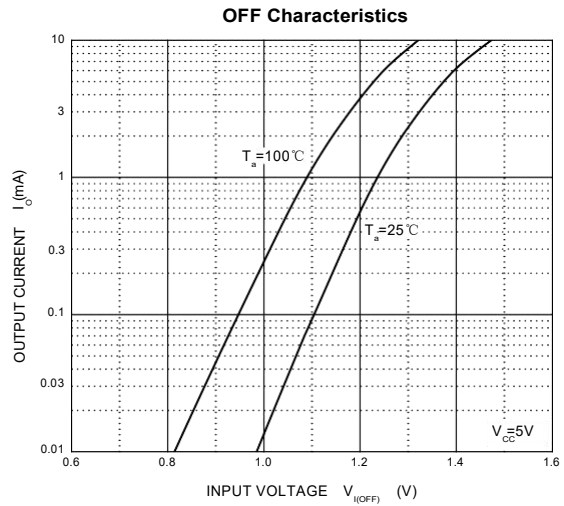
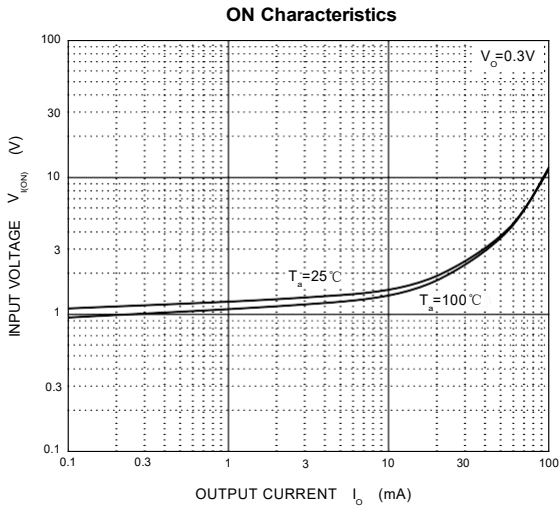

PACKAGE MECHANICAL DATA

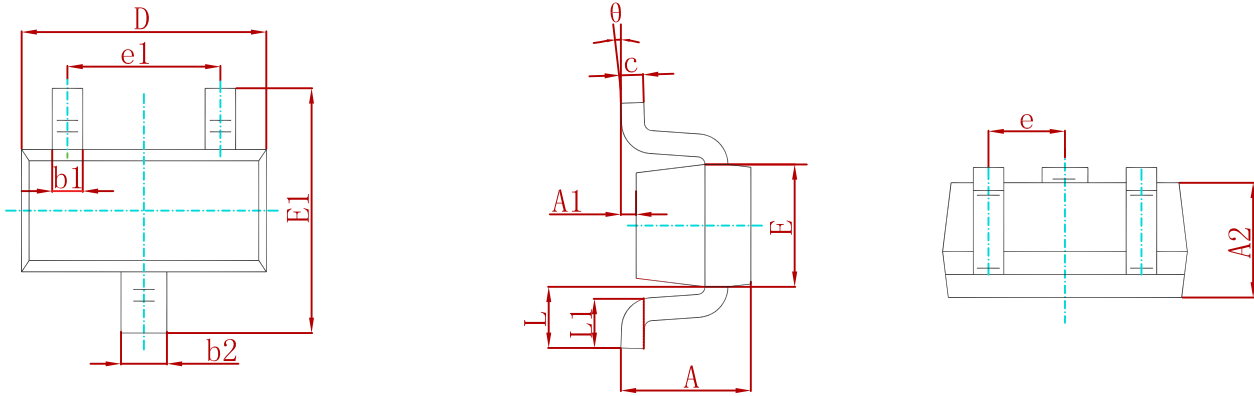

Symbol	Dimensions In Millimeters		Dimensions In Inches	
	Min.	Max.	Min.	Max.
A	0.700	0.900	0.028	0.035
A1	0.000	0.100	0.000	0.004
A2	0.700	0.800	0.028	0.031
b1	0.150	0.250	0.006	0.010
b2	0.250	0.350	0.010	0.014
c	0.100	0.200	0.004	0.008
D	1.500	1.700	0.059	0.067
E	0.700	0.900	0.028	0.035
E1	1.450	1.750	0.057	0.069
e	0.500 TYP.		0.020 TYP.	
e1	0.900	1.100	0.035	0.043
L	0.400 REF.		0.016 REF.	
L1	0.260	0.460	0.010	0.018
θ	0°	8°	0°	8°

Suggested Pad Layout

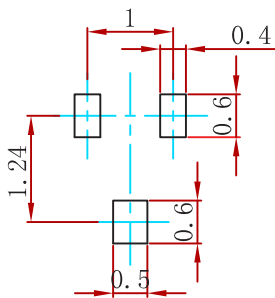

- Note:
1. Controlling dimension: in millimeters.
 2. General tolerance: ±0.05mm.
 3. The pad layout is for reference purposes only.

REEL SPECIFICATION

P/N	PKG	QTY
DTC143EE-MS	SOT-523	3000

PACKAGE MECHANICAL DATA

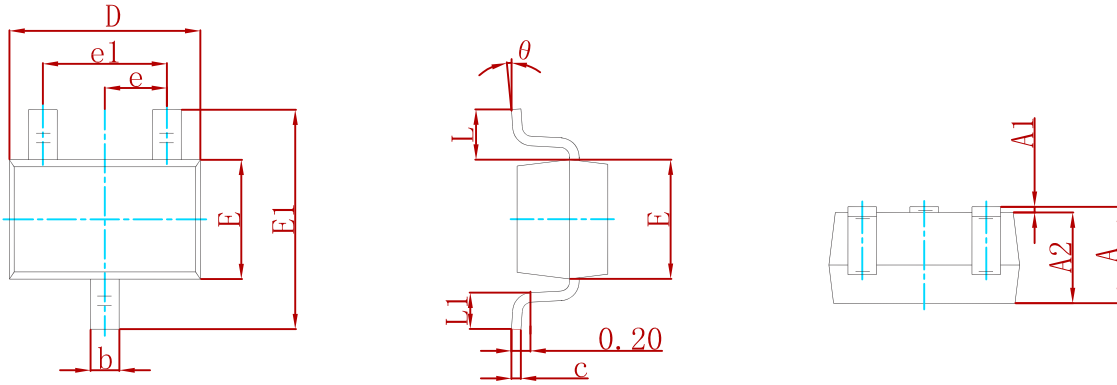

Symbol	Dimensions In Millimeters		Dimensions In Inches	
	Min	Max	Min	Max
A	0.900	1.100	0.035	0.043
A1	0.000	0.100	0.000	0.004
A2	0.900	1.000	0.035	0.039
b	0.200	0.400	0.008	0.016
c	0.080	0.150	0.003	0.006
D	2.000	2.200	0.079	0.087
E	1.150	1.350	0.045	0.053
E1	2.150	2.450	0.085	0.096
e	0.650 TYP		0.026 TYP	
e1	1.200	1.400	0.047	0.055
L	0.525 REF		0.021 REF	
L1	0.260	0.460	0.010	0.018
θ	0°	8°	0°	8°

Suggested Pad Layout

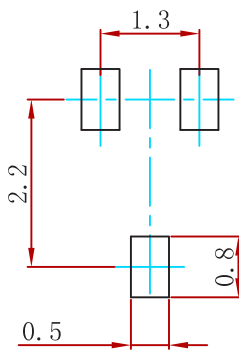

Note:
 1. Controlling dimension: in millimeters.
 2. General tolerance: ±0.05mm.
 3. The pad layout is for reference purposes only.

REEL SPECIFICATION

P/N	PKG	QTY
DTC143EUA-MS	SOT-323	3000

PACKAGE MECHANICAL DATA

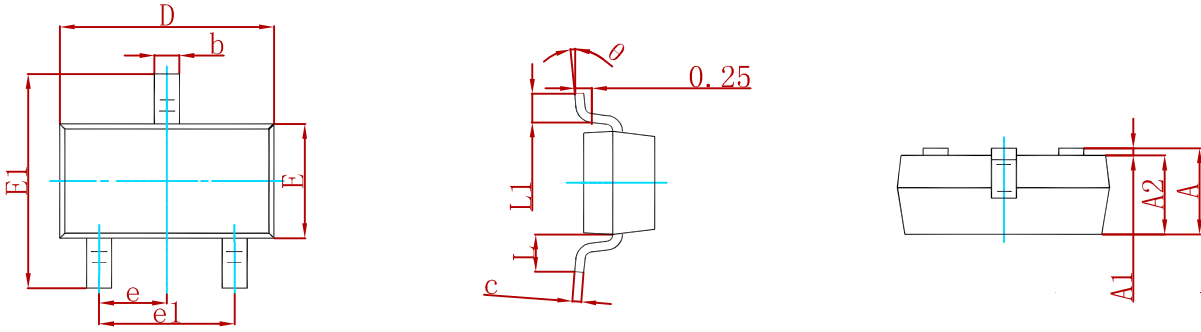

Symbol	Dimensions In Millimeters		Dimensions In Inches	
	Min	Max	Min	Max
A	0.900	1.150	0.035	0.045
A1	0.000	0.100	0.000	0.004
A2	0.900	1.050	0.035	0.041
b	0.300	0.500	0.012	0.020
c	0.080	0.150	0.003	0.006
D	2.800	3.000	0.110	0.118
E	1.200	1.400	0.047	0.055
E1	2.250	2.550	0.089	0.100
e	0.950 TYP		0.037 TYP	
e1	1.800	2.000	0.071	0.079
L	0.550 REF		0.022 REF	
L1	0.300	0.500	0.012	0.020
θ	0°	8°	0°	8°

Suggested Pad Layout

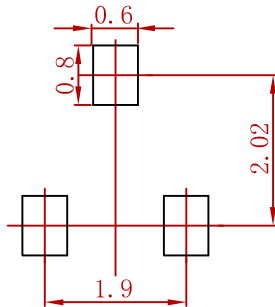

- Note:
1. Controlling dimension: in millimeters.
 2. General tolerance: ± 0.05mm.
 3. The pad layout is for reference purposes only.

REEL SPECIFICATION

P/N	PKG	QTY
DTC143ECA-MS	SOT-23	3000

PACKAGE MECHANICAL DATA

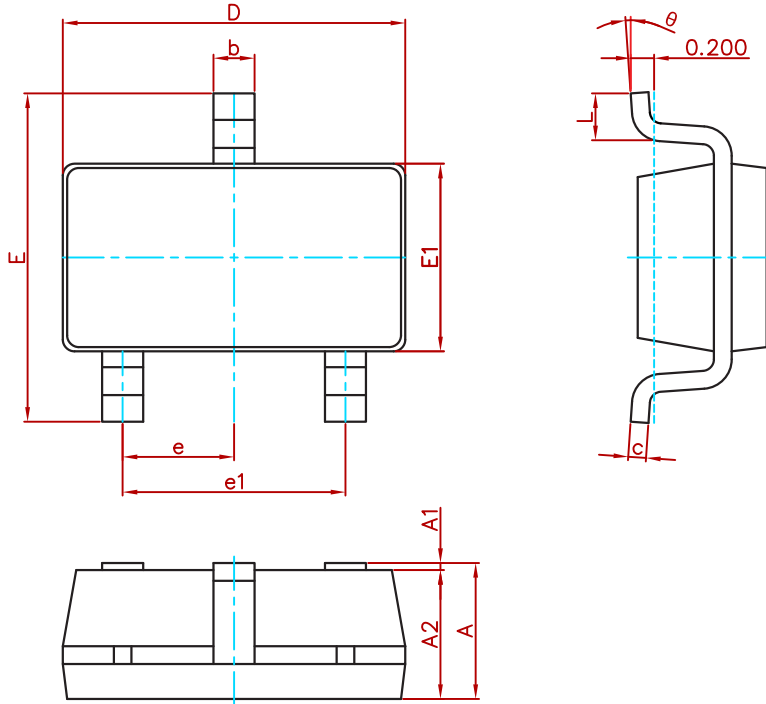

Symbol	Dimensions In Millimeters		Dimensions In Inches	
	Min.	Max.	Min.	Max.
A	1.050	1.250	0.041	0.049
A1	0.000	0.100	0.000	0.004
A2	1.050	1.150	0.041	0.045
b	0.300	0.500	0.012	0.020
c	0.100	0.200	0.004	0.008
D	2.820	3.020	0.111	0.119
E1	1.500	1.700	0.059	0.067
E	2.650	2.950	0.104	0.116
e	0.950(BSC)		0.037(BSC)	
e1	1.800	2.000	0.071	0.079
L	0.300	0.600	0.012	0.024
θ	0°	8°	0°	8°

Suggested Pad Layout

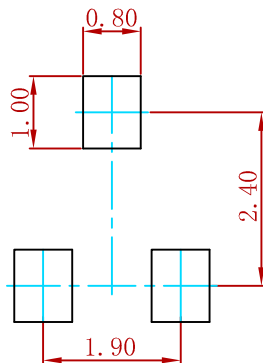

Note:
1. Controlling dimension: in millimeters.
2. General tolerance: ± 0.05mm.
3. The pad layout is for reference purposes only.

REEL SPECIFICATION

P/N	PKG	QTY
DTC143EKA-MS	SOT-23-3L	3000

Attention

- Any and all MSKSEMI Semiconductor products described or contained herein do not have specifications that can handle applications that require extremely high levels of reliability, such as life-support systems, aircraft's control systems, or other applications whose failure can be reasonably expected to result in serious physical and/or material damage. Consult with your MSKSEMI Semiconductor representative nearest you before using any MSKSEMI Semiconductor products described or contained herein in such applications.
- MSKSEMI Semiconductor assumes no responsibility for equipment failures that result from using products at values that exceed, even momentarily, rated values (such as maximum ratings, operating condition ranges, or other parameters) listed in products specifications of any and all MSKSEMI Semiconductor products described or contained herein.
- Specifications of any and all MSKSEMI Semiconductor products described or contained herein stipulate the performance, characteristics, and functions of the described products in the independent state, and are not guarantees of the performance, characteristics, and functions of the described products as mounted in the customer's products or equipment. To verify symptoms and states that cannot be evaluated in an independent device, the customer should always evaluate and test devices mounted in the customer's products or equipment.
- MSKSEMI Semiconductor strives to supply high-quality high-reliability products. However, any and all semiconductor products fail with some probability. It is possible that these probabilistic failures could give rise to accidents or events that could endanger human lives, that could give rise to smoke or fire, or that could cause damage to other property. When designing equipment, adopt safety measures so that these kinds of accidents or events cannot occur. Such measures include but are not limited to protective circuits and error prevention circuits for safe design, redundant design, and structural design.
- In the event that any or all MSKSEMI Semiconductor products (including technical data, services) described or contained herein are controlled under any of applicable local export control laws and regulations, such products must not be exported without obtaining the export license from the authorities concerned in accordance with the above law.
- No part of this publication may be reproduced or transmitted in any form or by any means, electronic or mechanical, including photocopying and recording, or any information storage or retrieval system, or otherwise, without the prior written permission of MSKSEMI Semiconductor.
- Information (including circuit diagrams and circuit parameters) herein is for example only ; it is not guaranteed for volume production. MSKSEMI Semiconductor believes information herein is accurate and reliable, but no guarantees are made or implied regarding its use or any infringement of intellectual property rights or other rights of third parties.
- Any and all information described or contained herein are subject to change without notice due to product/technology improvement, etc. When designing equipment, refer to the "Delivery Specification" for the MSKSEMI Semiconductor product that you intend to use.

单击下面可查看定价，库存，交付和生命周期等信息

[>>MSKSEMI\(美森科\)](#)