

MSKSEMI 美森科

SEMICONDUCTOR



ESD



TVS



TSS



MOV



GDT



PLED

2N7002K-7-MS

Product specification

Features



- 60V,0.3A, RDS(ON) =2.2Ω@VGS=10V
- Improved dv/dt capability
- Fast switching
- Green Device Available
- G-S ESD Protection Diode Embedded
- ESD protected up to 2KV

Application

- Motor Drive
- Power Tools
- LED Lighting

BVDSS	RDSON	ID
60V	2.2Ω	0.3A

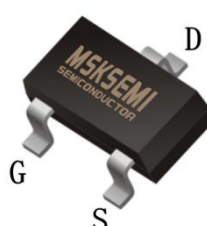
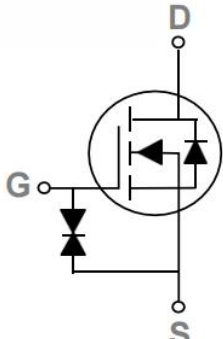
Reference News

PACKAGE OUTLINE	Pin Configuration	Marking
 <p>SOT-23</p>		

Absolute Maximum Ratings (TA=25°C unless otherwise noted)

Symbol	Parameter	Rating	Units
V _{DS}	Drain- Source Voltage	60	V
V _{GS}	Gate- Sou.rce Voltage	±20	V
I _D	Drain Current – Continuous (T _C =25°C)	0.3	A
	Drain Current – Continuous (T _C =100°C)	0.1	A
I _{DM}	Drain Current – Pulsed ¹	0.8	A
P _D	Power Dissipation (T _C =25°C)	0.35	W
	Power Dissipation – Derate above 25 °c	0.003	W/°C
T _{STG}	Storage Temperature Range	-50 to 150	°c
T _J	Operating Junction Temperature Range	-50 to 150	°c

Thermal Characteristics

Symbol	Parameter	Typ.	Max.	Unit
$R_{\theta JA}$	Thermal Resistance Junction to ambient	---	357	°C/W

Electrical Characteristics (T_J=25 °C , unless otherwise noted)

Off Characteristics

Symbol	Parameter	Conditions	Min.	Typ.	Max.	Unit
BV_{DSS}	Drain- Source Breakdown Voltage	$V_{GS}=0V, I_D=250\mu A$	60	---	---	V
I_{DSS}	Drain- Source Leakage Current	$V_{DS}=60V, V_{GS}=0V, T_J=25^\circ C$	---	---	1	μA
		$V_{DS}=48V, V_{GS}=0V, T_J=125^\circ C$	---	---	10	μA
I_{GSS}	Gate- Source Leakage Current	$V_{GS} \pm 20V, V_{DS}=0V$	---	---	±10	μA

On Characteristics

$R_{DS(ON)}$	Static Drain- Source On- Resistance	$V_{GS}=10V, I_D=0.3A$	---	2.2	2.8	Ω
		$V_{GS}=4.5V, I_D=0.2A$	---	2.4	3.0	Ω
$V_{GS(th)}$	Gate Threshold Voltage	$V_{GS}=V_{DS}, I_D=250\mu A$	1	1.6	2.5	V
g_{fs}	Forward Transconductance	$V_{DS}=10V, I_D=0.3A$	---	0.5	---	S

Dynamic and switching Characteristics

Q_g	Total Gate Charge ^{2, 3}	$V_{DS}=30V, V_{GS}=10V, I_D=1A$	---	3.7	5.6	nC
Q_{gs}	Gate-Source Charge ^{2, 3}		---	0.9	1.4	
Q_{gd}	Gate-Drain Charge ^{2, 3}		---	0.4	0.6	
$T_{d(on)}$	Turn-On Delay Time ^{2, 3}	$V_{DD}=30V, V_{GS}=10V, R_G=6\Omega$ $I_D=0.2A$	---	3	6	ns
T_r	Rise Time ^{2, 3}		---	5	10	
$T_{d(off)}$	Turn-Off Delay Time ^{2, 3}		---	14	27	
T_f	Fall Time ^{2, 3}		---	9	17	
C_{iss}	Input Capacitance	$V_{DS}=30V, V_{GS}=0V, F=1MHz$	---	25.5	38	pF
C_{oss}	Output Capacitance		---	17	26	
C_{rss}	Reverse Transfer Capacitance		---	7.8	12	

Drain-Source Diode Characteristics and Maximum Ratings

Symbol	Parameter	Conditions	Min.	Typ.	Max.	Unit
I_S	Continuous Source Current	$V_G=V_D=0V, \text{ Force Current}$	---	---	0.3	A
I_{SM}	Pulsed Source Current		---	---	1.2	A
V_{SD}	Diode Forward Voltage	$V_{GS}=0V, I_S=1A, T_J=25^\circ C$	---	---	1.2	V
t_{rr}	Reverse Recovery Time	$V_{GS}=50V, I_S=1A, dI/dt=100A/\mu s$	---	3.4	---	ns
Q_{rr}	Reverse Recovery Charge	$T_J=25^\circ C$	---	0.7	---	nC

Note :

- 1.Repetitive Rating : Pulsed width limited by maximum junction temperature.
2. The data tested by pulsed , pulse width $\leq 300\mu s$, duty cycle $\leq 2\%$.
3. Essentially independent of operating temperature.

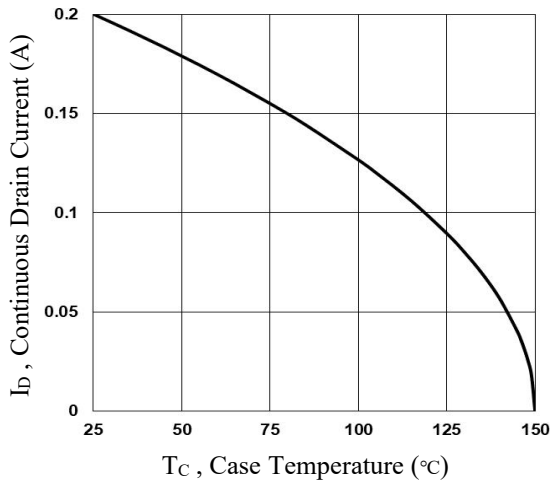

Fig.1 Continuous Drain Current vs. T_c

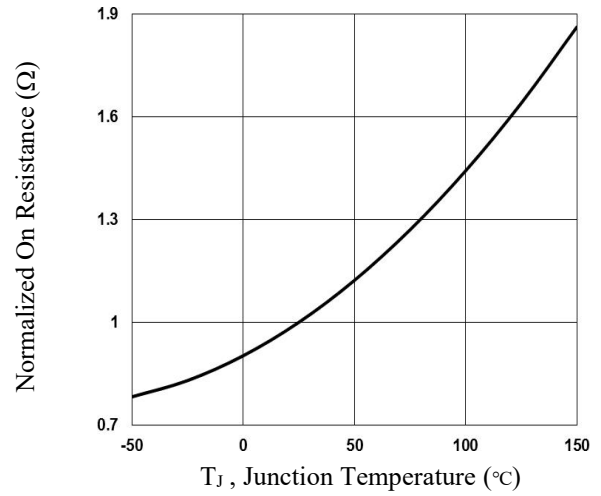

Fig.2 Normalized $R_{DS(on)}$ vs. T_j

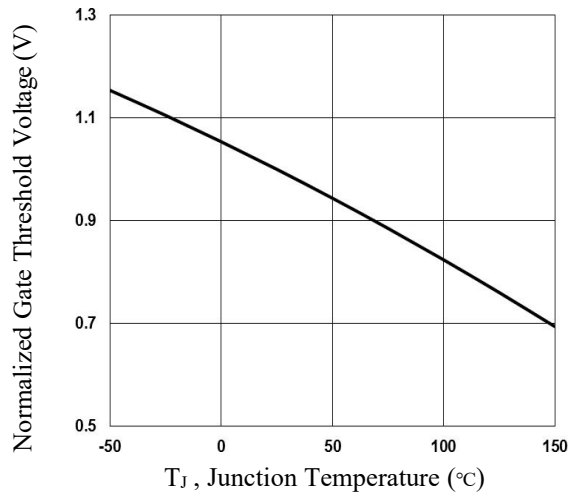

Fig.3 Normalized V_{th} vs. T_j

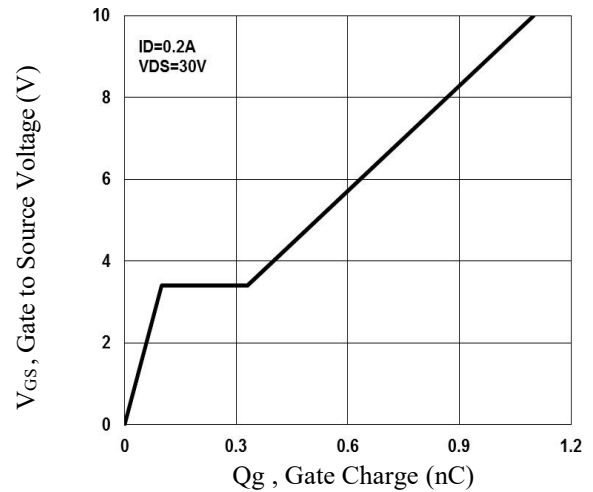

Fig.4 Gate Charge Waveform

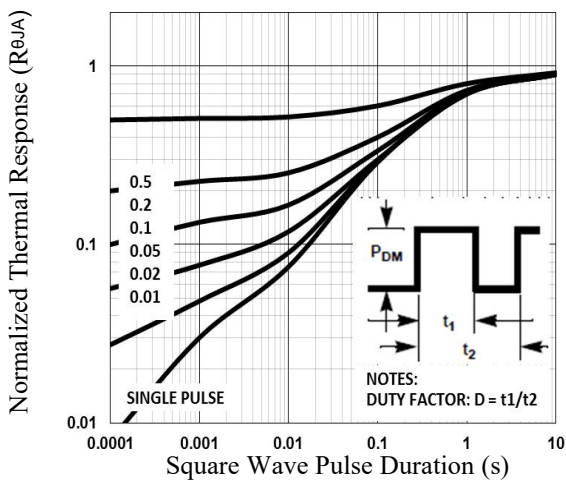

Fig.5 Normalized Transient Impedance

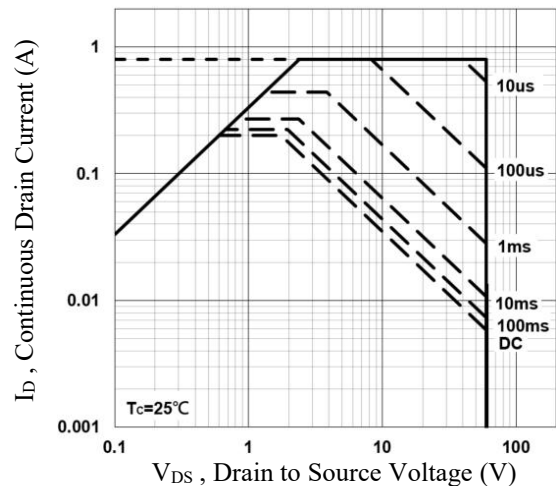
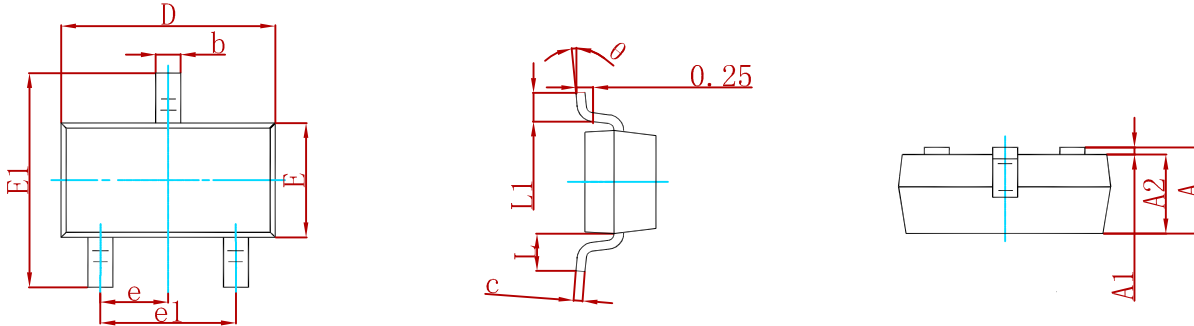

Fig.6 Maximum Safe Operation Area

PACKAGE MECHANICAL DATA



Symbol	Dimensions In Millimeters		Dimensions In Inches	
	Min	Max	Min	Max
A	0.900	1.150	0.035	0.045
A1	0.000	0.100	0.000	0.004
A2	0.900	1.050	0.035	0.041
b	0.300	0.500	0.012	0.020
c	0.080	0.150	0.003	0.006
D	2.800	3.000	0.110	0.118
E	1.200	1.400	0.047	0.055
E1	2.250	2.550	0.089	0.100
e	0.950 TYP		0.037 TYP	
e1	1.800	2.000	0.071	0.079
L	0.550 REF		0.022 REF	
L1	0.300	0.500	0.012	0.020
θ	0°	8°	0°	8°

Suggested Pad Layout

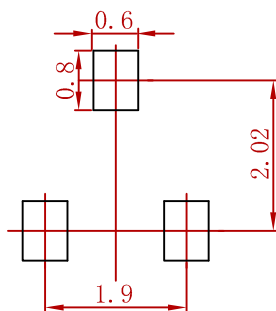

Note:
 1. Controlling dimension: in millimeters.
 2. General tolerance: ± 0.05mm.
 3. The pad layout is for reference purposes only.

REEL SPECIFICATION

P/N	PKG	QTY
2N7002K-7-MS	SOT-23	3000

Attention

- Any and all MSKSEMI Semiconductor products described or contained herein do not have specifications that can handle applications that require extremely high levels of reliability, such as life-support systems, aircraft's control systems, or other applications whose failure can be reasonably expected to result in serious physical and/or material damage. Consult with your MSKSEMI Semiconductor representative nearest you before using any MSKSEMI Semiconductor products described or contained herein in such applications.
- MSKSEMI Semiconductor assumes no responsibility for equipment failures that result from using products at values that exceed, even momentarily, rated values (such as maximum ratings, operating condition ranges, or other parameters) listed in products specifications of any and all MSKSEMI Semiconductor products described or contained herein.
- Specifications of any and all MSKSEMI Semiconductor products described or contained herein stipulate the performance, characteristics, and functions of the described products in the independent state, and are not guarantees of the performance, characteristics, and functions of the described products as mounted in the customer's products or equipment. To verify symptoms and states that cannot be evaluated in an independent device, the customer should always evaluate and test devices mounted in the customer's products or equipment.
- MSKSEMI Semiconductor strives to supply high-quality high-reliability products. However, any and all semiconductor products fail with some probability. It is possible that these probabilistic failures could give rise to accidents or events that could endanger human lives, that could give rise to smoke or fire, or that could cause damage to other property. When designing equipment, adopt safety measures so that these kinds of accidents or events cannot occur. Such measures include but are not limited to protective circuits and error prevention circuits for safe design, redundant design, and structural design.
- In the event that any or all MSKSEMI Semiconductor products (including technical data, services) described or contained herein are controlled under any of applicable local export control laws and regulations, such products must not be exported without obtaining the export license from the authorities concerned in accordance with the above law.
- No part of this publication may be reproduced or transmitted in any form or by any means, electronic or mechanical, including photocopying and recording, or any information storage or retrieval system, or otherwise, without the prior written permission of MSKSEMI Semiconductor.
- Information (including circuit diagrams and circuit parameters) herein is for example only ; it is not guaranteed for volume production. MSKSEMI Semiconductor believes information herein is accurate and reliable, but no guarantees are made or implied regarding its use or any infringements of intellectual property rights or other rights of third parties.
- Any and all information described or contained herein are subject to change without notice due to product/technology improvement, etc. When designing equipment, refer to the "Delivery Specification" for the MSKSEMI Semiconductor product that you intend to use.

单击下面可查看定价，库存，交付和生命周期等信息

[>>MSKSEMI\(美森科\)](#)