

MSKSEMI 美森科

SEMICONDUCTOR



ESD



TVS



TSS



MOV



GDT



PLED

MURSXXXT3G-MS

Product specification



SURFACE MOUNT ULTRAFAST POWER RECTIFIERS DIODES**VOLTAGE RANGE: 50 - 600V****CURRENT: 3.0A****Features**

- Glass Passivated Die Construction
- Ideally Suited for Automatic Assembly
- Low Forward Voltage Drop, High Efficiency
- Low Power Loss
- Super-Fast Recovery Time
- Plastic Case Material has UL Flammability Classification Rating 94V-O

Mechanical Data

- Case: SMA/DO-214AA, Molded Plastic
- Terminals: Solder Plated, Solderable
- per MIL-STD-750, Method 2026
- Polarity: Cathode Band or Cathode Notch
- Weight: 0.21 grams (approx.)

Reference News

PACKAGE OUTLINE	Marking
	
SMC(DO-214AB)	*** Representative VRRM

Maximum Ratings and Electrical Characteristics $T_A = 25^\circ\text{C}$ unless otherwise specified Single phase, half wave, 60Hz, resistive or inductive load. For capacitive load, derate current by 20%.

Characteristic	Symbol	MURS305 T3G-MS	MURS310 T3G-MS	MURS315 T3G-MS	MURS320 T3G-MS	MURS330 T3G-MS	MURS340 T3G-MS	MURS360 T3G-MS	Unit
Peak Repetitive Reverse Voltage	V_{RRM}								
Working Peak Reverse Voltage	V_{RWM}	50	100	150	200	300	400	600	V
DC Blocking Voltage	V_R								
RMS Reverse Voltage	$V_{R(RMS)}$	35	70	105	140	210	280	420	V
Average Rectified Output Current @ $T_L = 75^\circ\text{C}$	I_o	3.0							A
Non-Repetitive Peak Forward Surge Current 8.3ms Single half sine-wave superimposed on rated load (JEDEC Method)	I_{FSM}	100							A
Forward Voltage @ $I_F = 3.0\text{A}$	V_{FM}	0.95				1.25		1.7	V
Peak Reverse Current At Rated DC Blocking Voltage	I_{RM}					5.0			μA
						500			
Reverse Recovery Time (Note 1)	t_{rr}	35							nS
Typical Junction Capacitance (Note 2)	C_j	45							pF
Typical Thermal Resistance (Note 3)	$R_{\theta JL}$	16							$^\circ\text{C/W}$
Operating and Storage Temperature Range	T_j, T_{STG}	-65 to +150							$^\circ\text{C}$

- Note: 1. Measured with $I_F = 0.5\text{A}$, $I_R = 1.0\text{A}$, $I_{rr} = 0.25\text{A}$. See figure 5.
 2. Measured at 1.0 MHz and applied reverse voltage of 4.0 V DC.
 3. Mounted on P.C. Board with 8.0mm² land area.

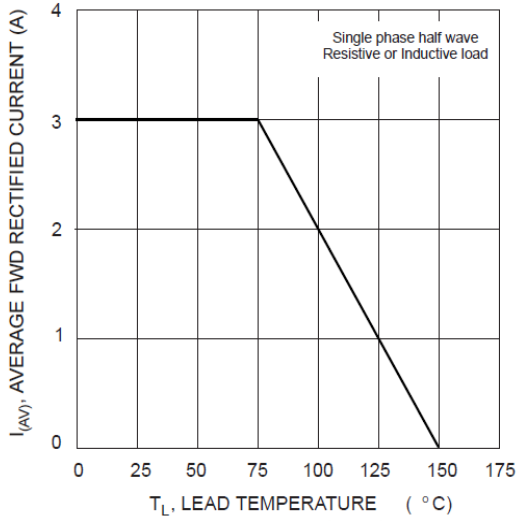

Fig. 1 Forward Current Derating Curve

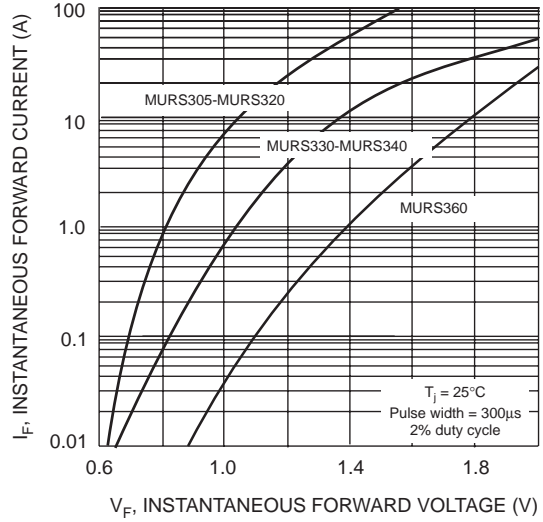

Fig. 2 Typical Forward Characteristics

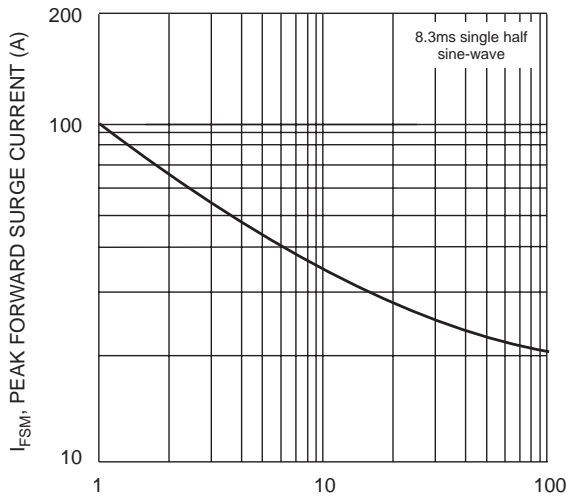

Fig. 3 Peak Forward Surge Current

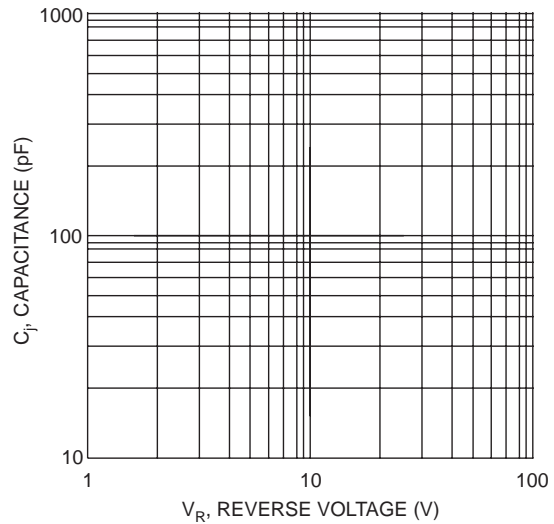
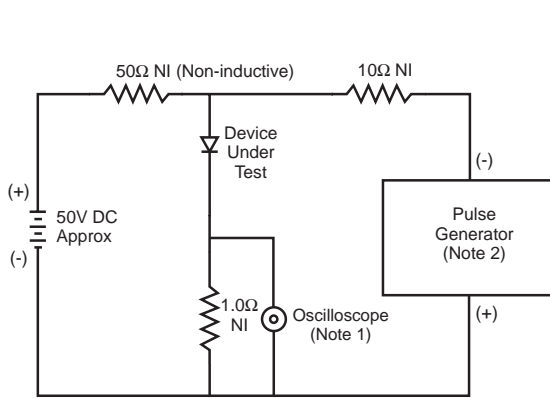
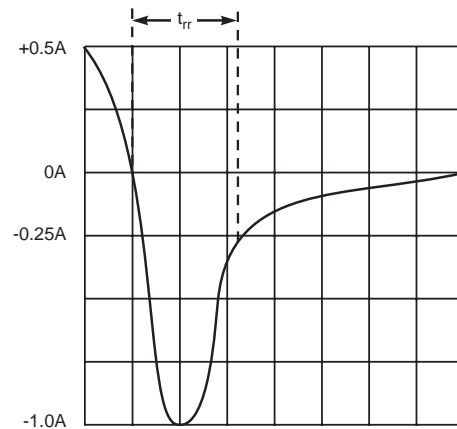

Fig. 4 Typical Junction Capacitance



- Notes:
 1. Rise Time = 7.0ns max. Input Impedance = 1.0MΩ, 22pF.
 2. Rise Time = 10ns max. Input Impedance = 50Ω.



Set time base for 5/10ns/cm

Fig. 5 Reverse Recovery Time Characteristic and Test Circuit

PACKAGE MECHANICAL DATA

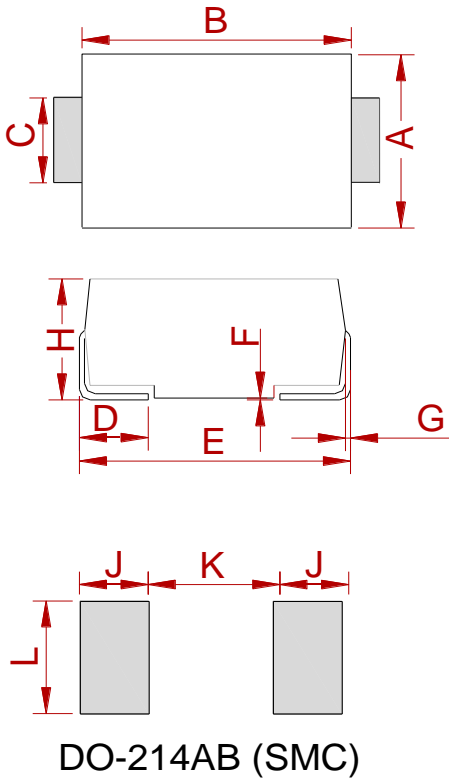

Ref.	Dimensions			
	Millimeters		Inches	
	Min.	Max.	Min.	Max.
A	5.75	6.25	0.226	0.246
B	6.90	7.40	0.272	0.291
C	2.75	3.25	0.108	0.128
D	0.95	1.52	0.037	0.060
E	7.70	8.20	0.303	0.323
F	0.051	0.203	0.002	0.008
G	0.15	0.31	0.006	0.012
H	2.15	2.62	0.085	0.103
J	2.40		0.094	
K		4.20		0.165
L	3.30		0.130	

REEL SPECIFICATION

P/N	PKG	QTY
MURSXXXT3G-MS	SMC	2500

Attention

- Any and all MSKSEMI Semiconductor products described or contained herein do not have specifications that can handle applications that require extremely high levels of reliability, such as life-support systems, aircraft's control systems, or other applications whose failure can be reasonably expected to result in serious physical and/or material damage. Consult with your MSKSEMI Semiconductor representative nearest you before using any MSKSEMI Semiconductor products described or contained herein in such applications.
- MSKSEMI Semiconductor assumes no responsibility for equipment failures that result from using products at values that exceed, even momentarily, rated values (such as maximum ratings, operating condition ranges, or other parameters) listed in products specifications of any and all MSKSEMI Semiconductor products described or contained herein.
- Specifications of any and all MSKSEMI Semiconductor products described or contained herein stipulate the performance, characteristics, and functions of the described products in the independent state, and are not guarantees of the performance, characteristics, and functions of the described products as mounted in the customer's products or equipment. To verify symptoms and states that cannot be evaluated in an independent device, the customer should always evaluate and test devices mounted in the customer's products or equipment.
- MSKSEMI Semiconductor strives to supply high-quality high-reliability products. However, any and all semiconductor products fail with some probability. It is possible that these probabilistic failures could give rise to accidents or events that could endanger human lives, that could give rise to smoke or fire, or that could cause damage to other property. When designing equipment, adopt safety measures so that these kinds of accidents or events cannot occur. Such measures include but are not limited to protective circuits and error prevention circuits for safe design, redundant design, and structural design.
- In the event that any or all MSKSEMI Semiconductor products (including technical data, services) described or contained herein are controlled under any of applicable local export control laws and regulations, such products must not be exported without obtaining the export license from the authorities concerned in accordance with the above law.
- No part of this publication may be reproduced or transmitted in any form or by any means, electronic or mechanical, including photocopying and recording, or any information storage or retrieval system, or otherwise, without the prior written permission of MSKSEMI Semiconductor.
- Information (including circuit diagrams and circuit parameters) herein is for example only ; it is not guaranteed for volume production. MSKSEMI Semiconductor believes information herein is accurate and reliable, but no guarantees are made or implied regarding its use or any infringements of intellectual property rights or other rights of third parties.
- Any and all information described or contained herein are subject to change without notice due to product/technology improvement, etc. When designing equipment, refer to the "Delivery Specification" for the MSKSEMI Semiconductor product that you intend to use.

单击下面可查看定价，库存，交付和生命周期等信息

[>>MSKSEMI\(美森科\)](#)