

SF2244A

**225 MHz
SAW Filter**

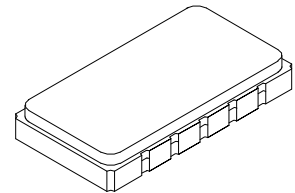

SMP-53-S

- **Low Insertion Loss**
- **Excellent Size-to-performance Ratio**
- **Hermetic 13.3 x 6.5 mm Surface-mount Case**
- **Single-ended Input and Output**
- **Complies with Directive 2002/95/EC (RoHS)**



Absolute Maximum Ratings

Rating	Value	Units
Maximum Incident Power in Passband	+18	dBm
Maximum DC Voltage on any Non-ground Terminal	10	VDC
Storage Temperature Range in Tape and Reel	-40 to +85	°C
Suitable for Lead-free Soldering - Maximum Soldering Profile	260 °C for 30 s	

Electrical Specifications

Characteristic	Sym	Notes	Min	Typ	Max	Units
Center Frequency	f_C	1	225.0			MHz
Maximum Insertion Loss	IL_{MAX}		10.0	12.0	dB	
Passband Ripple, 223.0 to 227.0 MHz			0.6	1.0	dB _{P-P}	
1 dB Bandwidth	BW_1	1, 2	4.0	5.1	-	MHz
3 dB Bandwidth	BW_3		-	5.7	-	MHz
45 dB Bandwidth	BW_{45}		-	9.4	10.0	MHz
Rejection Referenced to IL_{MIN} :		1, 2, 3				dB
1 to 210 MHz			45	53		
238 to 400 MHz			45	51		
Operating Temperature Range	T_A	1	-20		+70	°C
Frequency Temperature Coefficient				-23		ppm/°C
Wafer Material			LiTaO ₃			

Impedance Matching to 50 Ω Single-ended Source and Load	External L-C
Case Style	SMP-53-S 13.3 x 6.5 mm Nominal Footprint
Lid Symbolization (YY = year, WW = week)	RFM/SF2244A/YYWW



CAUTION: Electrostatic Sensitive Device. Observe precautions for handling.

NOTES:

1. Unless noted otherwise, all specifications apply over the operating temperature range with filter soldered to the specified demonstration board with impedance matching to 50 Ω and measured with 50 Ω network analyzer.
2. Unless noted otherwise, all frequency specifications are referenced to the nominal center frequency, f_C .
3. Rejection is measured as attenuation below the minimum IL point in the passband. Rejection in final user application is dependent on PCB layout and external impedance matching design. See Application Note No. 42 for details.
4. The turnover temperature, T_O , is the temperature of maximum (or turnover) frequency, f_o . The nominal frequency at any case temperature, T_C , may be calculated from: $f=f_o[1-FTC(T_o-T_c)]^2$.
5. The design, manufacturing process, and specifications of this filter are subject to change.
6. Either Port 1 or Port 2 may be used for either input or output in the design. However, impedances and impedance matching may vary between Port 1 and Port 2, so that the filter must always be installed in one direction per the circuit design.
7. US and international patents may apply.

Frequency Response Plots

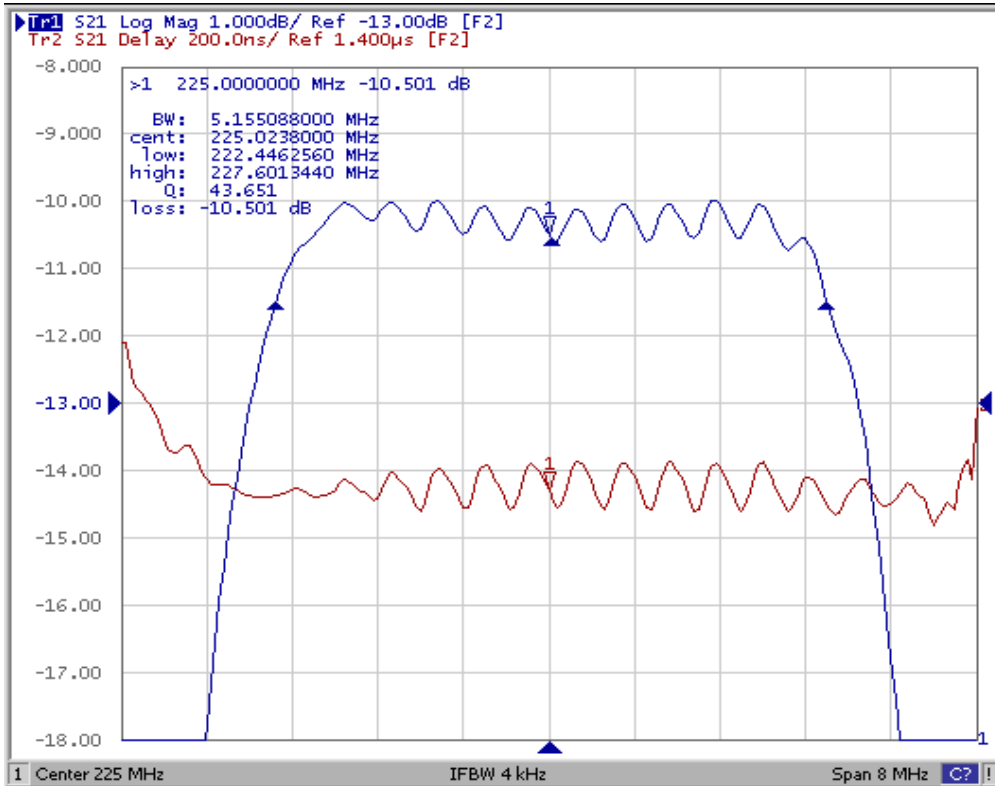
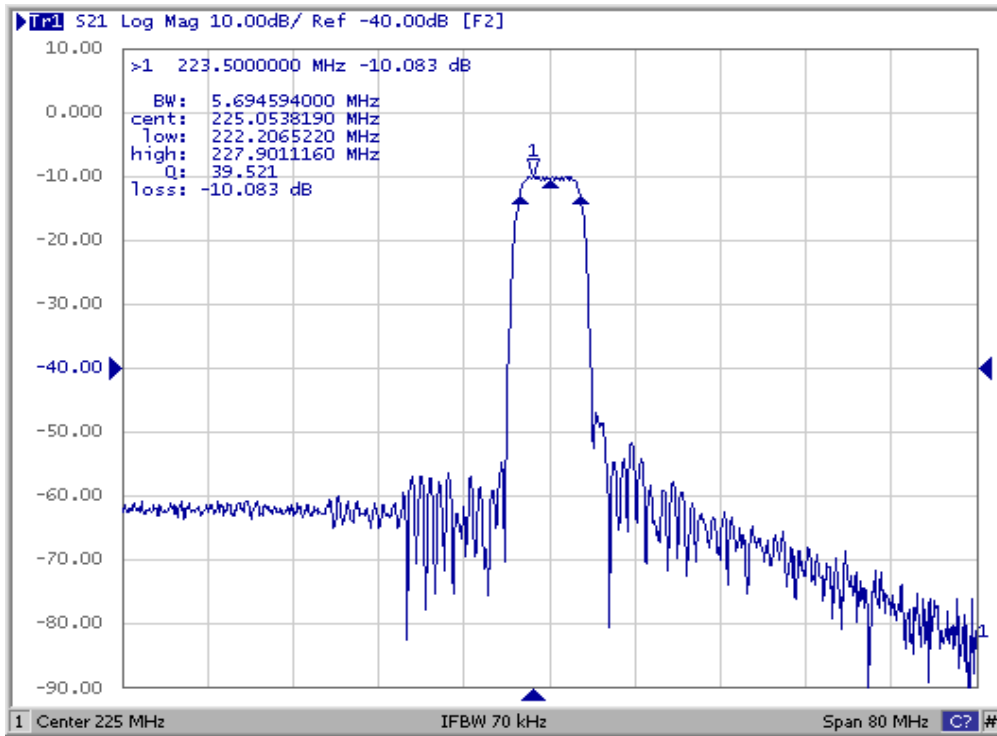

Input/Output Impedance Plots

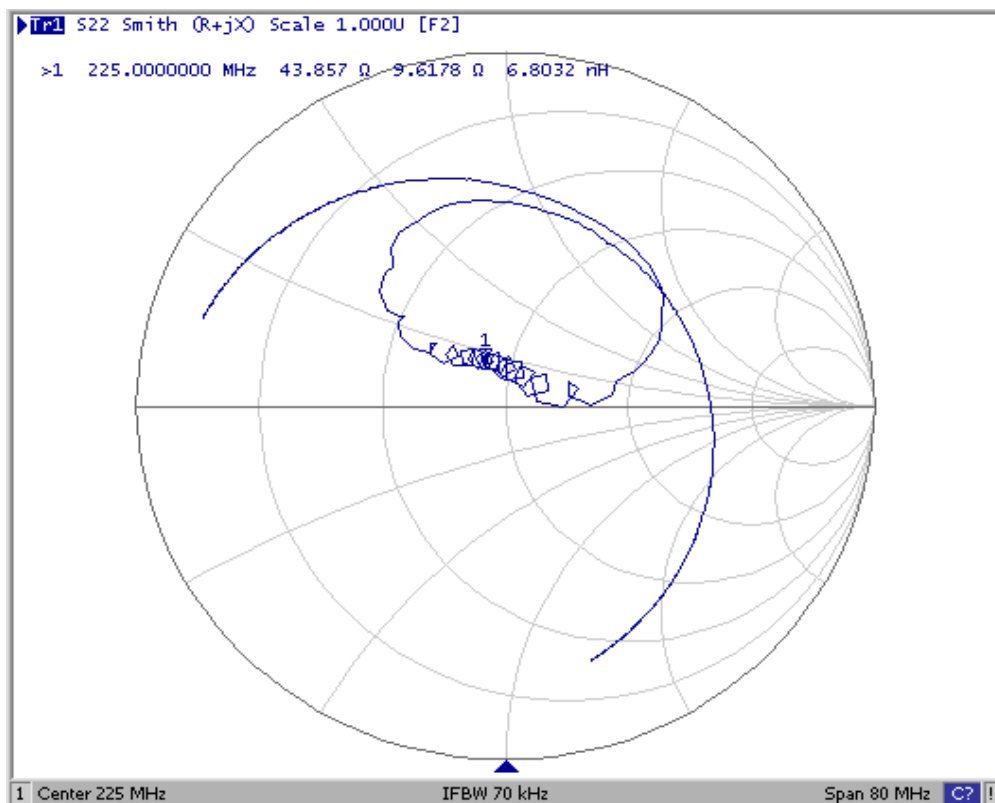
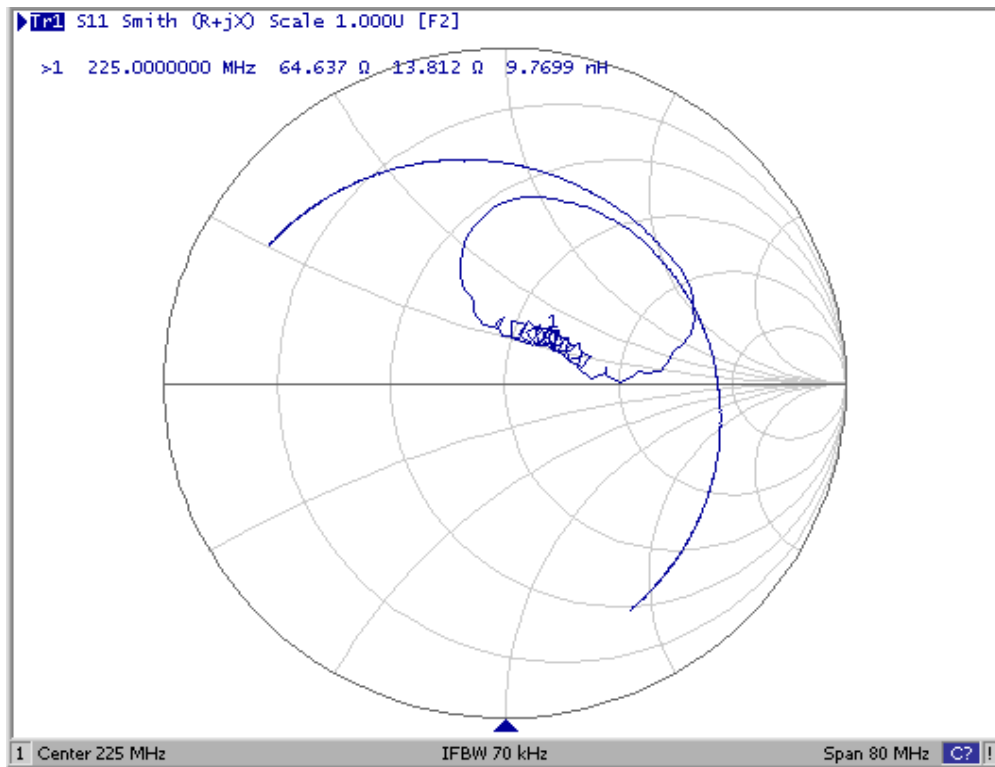

SMP-53-S Ceramic Surface-mount 10-terminal Case

13.3 x 6.5 mm Nominal Footprint

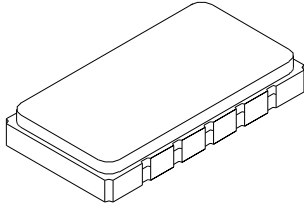

Electrical Connections

Connection	Terminals
Input	10
Output	5
Case Ground	All others

Case Dimensions

Dimension	mm			Inches		
	Min	Nom	Max	Min	Nom	Max
A		13.3			.524	
B		6.5			.256	
C			2.00			.078
D		2.3			.091	
E		1.91			.075	
F		1.02			.040	
G		1.0			0.039	

Case Material

Materials	
Solder Pad Plating	0.3 to 1.0 μm Gold over 1.27 to 8.89 μm Nickel
Lid Plating	2.0 to 3.0 μm Nickel
Body	Al_2O_3 Ceramic
Pb Free	

Typical Matching Network

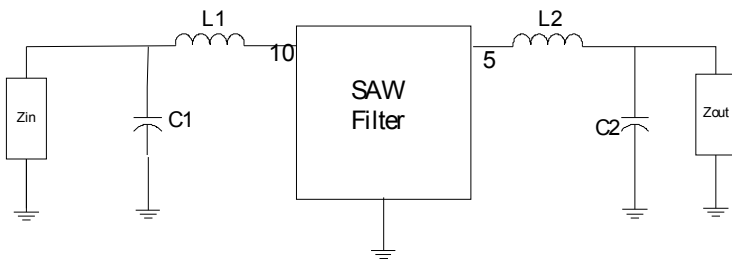

$L1 = 33 \text{ nH}$, $C1 = 20 \text{ pF}$, $L2 = 33 \text{ nH}$, $C2 = 24 \text{ pF}$

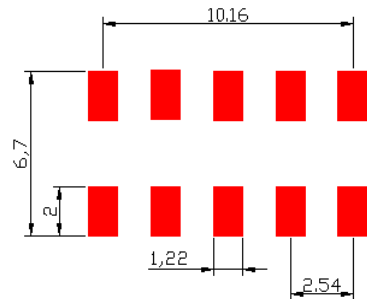

PCB Footprint (mm)

Case Outline Drawing

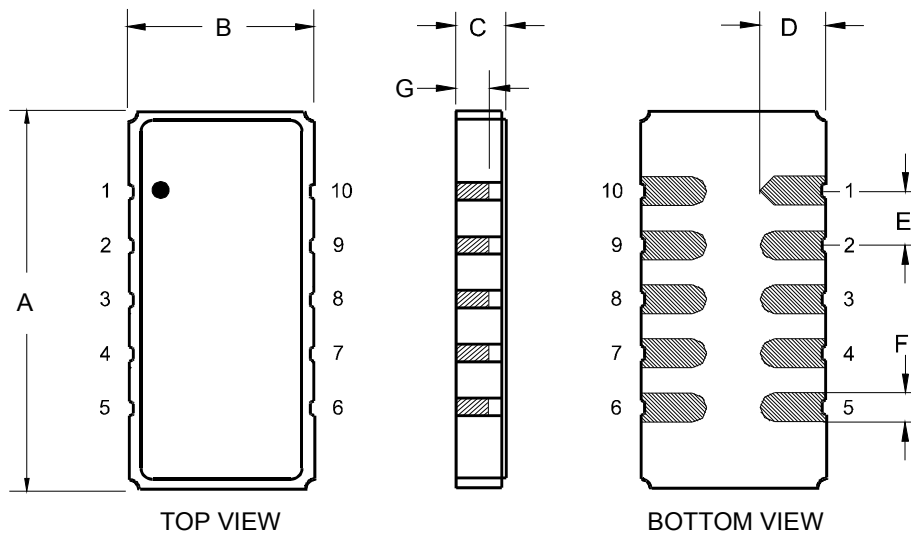

Reel Dimensions

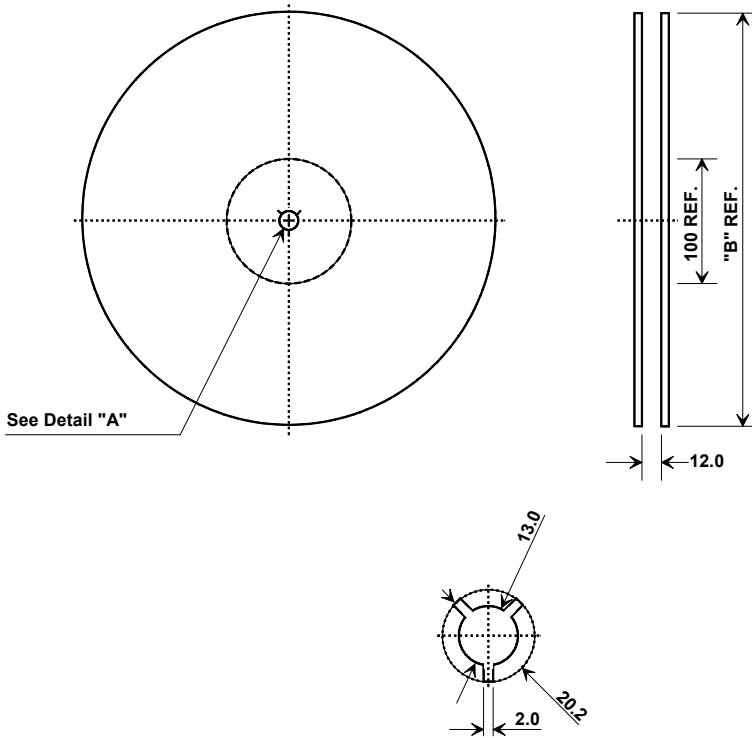

"B"		Quantity Per Reel
Nominal Size		
Inches	millimeters	
7	178	500
13	330	2000

Tape Dimensions

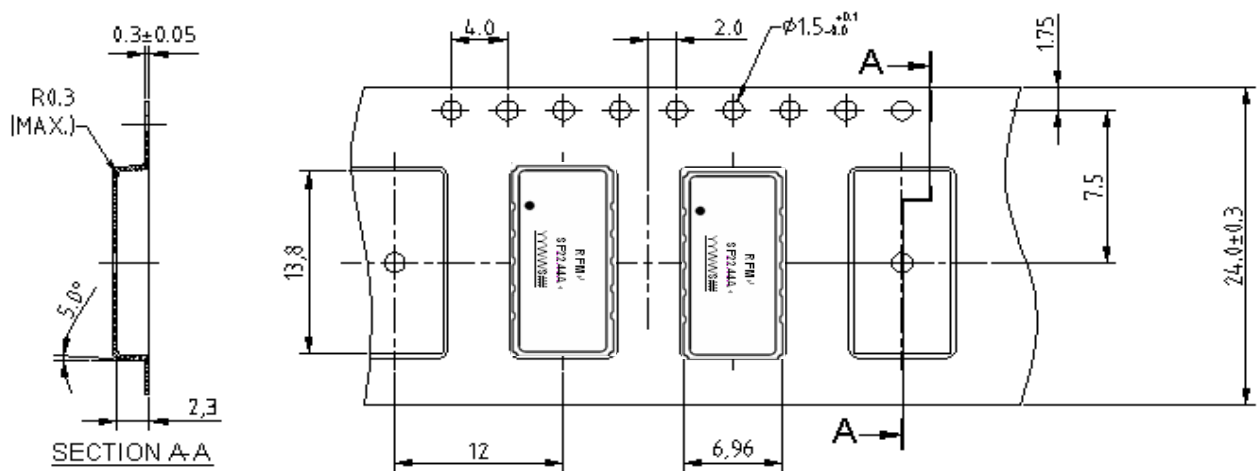

单击下面可查看定价，库存，交付和生命周期等信息

[>>Murata\(村田\)](#)