

CHIP EMIFIL®CHIP 3-TERMINAL CAPACITOR FOR LARGE CURRENT FOR GENERAL NFM18CC Series

Reference Sheet

1.Scope

This product specification is applied to Chip EMIFIL®Chip 3-terminal Capacitor used for General Electronic equipment.

2.Reference PART No. List

	Customer PART NO.	MURATA PART NO.
1		NFM18CC101R1C3D
2		NFM18CC102R1C3D
3		NFM18CC220U1C3D
4		NFM18CC221R1C3D
5		NFM18CC222R1C3D
6		NFM18CC223R1C3D
7		NFM18CC470U1C3D
8		NFM18CC471R1C3D

3.MURATA Part NO. System

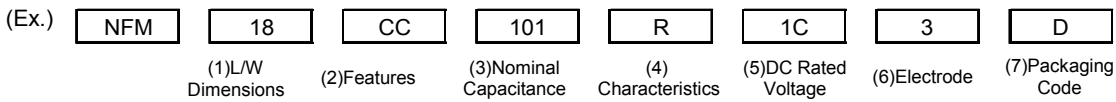

4. Type & Dimensions

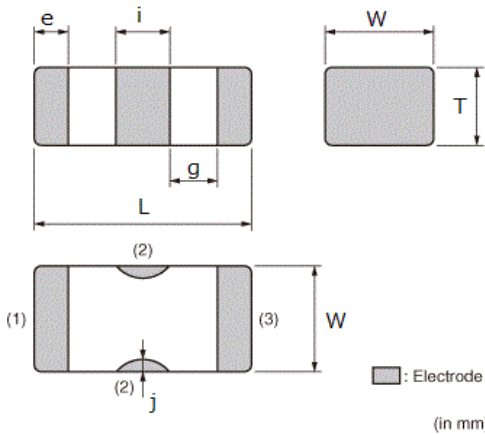

(Unit:mm)

	MURATA PART NO.	(1)-1 L	(1)-2 W	T	e	g
		i	j			
1	NFM18CC101R1C3D	1.6±0.1	0.8±0.1	0.6±0.1	0.25±0.1	0.2 min.
		0.4±0.1	0.2±0.1			
2	NFM18CC102R1C3D	1.6±0.1	0.8±0.1	0.6±0.1	0.25±0.1	0.2 min.
		0.4±0.1	0.2±0.1			
3	NFM18CC220U1C3D	1.6±0.1	0.8±0.1	0.6±0.1	0.25±0.1	0.2 min.
		0.4±0.1	0.2±0.1			
4	NFM18CC221R1C3D	1.6±0.1	0.8±0.1	0.6±0.1	0.25±0.1	0.2 min.
		0.4±0.1	0.2±0.1			
5	NFM18CC222R1C3D	1.6±0.1	0.8±0.1	0.6±0.1	0.25±0.1	0.2 min.
		0.4±0.1	0.2±0.1			
6	NFM18CC223R1C3D	1.6±0.1	0.8±0.1	0.6±0.1	0.25±0.1	0.2 min.
		0.4±0.1	0.2±0.1			
7	NFM18CC470U1C3D	1.6±0.1	0.8±0.1	0.6±0.1	0.25±0.1	0.2 min.
		0.4±0.1	0.2±0.1			
8	NFM18CC471R1C3D	1.6±0.1	0.8±0.1	0.6±0.1	0.25±0.1	0.2 min.
		0.4±0.1	0.2±0.1			

a)Equivalent Circuit

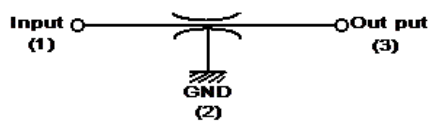

⊗No Polarity

5. Rated value

	MURATA PART NO.	(3) Nominal Capacitance	Capacitance Tolerance	(5) Rated Voltage	Rated Current (mA)	DC Resistance	Insulation Resistance	Specifications and Test Methods (Operating / Storage Temp. Range)
1	NFM18CC101R1C3D	100 pF	±20 %	DC 16 V	500mA(DC)	0.3Ωmax.	1000MΩmin.	Section 7.1 (-55 to 125 °C / -55 to 125 °C)
2	NFM18CC102R1C3D	1000 pF	±20 %	DC 16 V	600mA(DC)	0.3Ωmax.	1000MΩmin.	Section 7.1 (-55 to 125 °C / -55 to 125 °C)
3	NFM18CC220U1C3D	22 pF	±20 %	DC 16 V	400mA(DC)	0.3Ωmax.	1000MΩmin.	Section 7.1 (-55 to 125 °C / -55 to 125 °C)
4	NFM18CC221R1C3D	220 pF	±20 %	DC 16 V	500mA(DC)	0.3Ωmax.	1000MΩmin.	Section 7.1 (-55 to 125 °C / -55 to 125 °C)
5	NFM18CC222R1C3D	2200 pF	±20 %	DC 16 V	700mA(DC)	0.3Ωmax.	1000MΩmin.	Section 7.1 (-55 to 125 °C / -55 to 125 °C)
6	NFM18CC223R1C3D	22000 pF	±20 %	DC 16 V	1A(DC)	0.05Ωmax.	1000MΩmin.	Section 7.1 (-55 to 125 °C / -55 to 125 °C)
7	NFM18CC470U1C3D	47 pF	±20 %	DC 16 V	400mA(DC)	0.3Ωmax.	1000MΩmin.	Section 7.1 (-55 to 125 °C / -55 to 125 °C)
8	NFM18CC471R1C3D	470 pF	±20 %	DC 16 V	500mA(DC)	0.3Ωmax.	1000MΩmin.	Section 7.1 (-55 to 125 °C / -55 to 125 °C)

6. Package

	MURATA PART NO.	(7) Packaging	Packaging Unit
1	NFM18CC101R1C3D	φ180mm Reel PAPER	4000 pcs./Reel
2	NFM18CC102R1C3D	φ180mm Reel PAPER	4000 pcs./Reel
3	NFM18CC220U1C3D	φ180mm Reel PAPER	4000 pcs./Reel
4	NFM18CC221R1C3D	φ180mm Reel PAPER	4000 pcs./Reel
5	NFM18CC222R1C3D	φ180mm Reel PAPER	4000 pcs./Reel
6	NFM18CC223R1C3D	φ180mm Reel PAPER	4000 pcs./Reel
7	NFM18CC470U1C3D	φ180mm Reel PAPER	4000 pcs./Reel
8	NFM18CC471R1C3D	φ180mm Reel PAPER	4000 pcs./Reel

Product specifications in this catalog are as of Dec.15,2014,and are subject to change or obsolescence without notice.
Please consult the approval sheet before ordering.
Please read rating and !Cautions first.

■ SPECIFICATIONS AND TEST METHODS
Electrical Performance

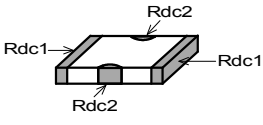
No	Item	Specification	Test Method
1	Capacitance (Cap.)	Meet item 5.	Frequency 22 to 47pF : 1±0.1MHz 100 to 22000pF : 1±0.1kHz Voltage : 1±0.2V(rms)
2	Insulation Resistance(I.R.)		Voltage : Rated Voltage Time : 2 minutes max.
3	DC Resistance (Rdc1,2)		Measured with 100mA max. Rdc1 : between signal terminals Rdc2 : between ground terminals 
4	Withstanding Voltage	Products shall not be damaged.	Test Voltage : Rated Voltage x 300% Time : 1 to 5 s Charge Current : 50 mA max.
5	Operating Temperature	Shown in item 5.	Includes self-heating
6	Storage Temperature		

Standard Testing Condition

< Unless otherwise specified >

Temperature : Ordinary Temp. / 15 °C to 35 °C

Humidity: Ordinary Humidity / 25 %(RH) to 85 %(RH)

< In case of doubt >

Temperature: 20 °C ± 2 °C

Humidity: 60 %(RH) to 70 %(RH)

Atmospheric pressure: 86 kPa to 106 kPa

SPECIFICATIONS AND TEST METHODS

Mechanical Performance

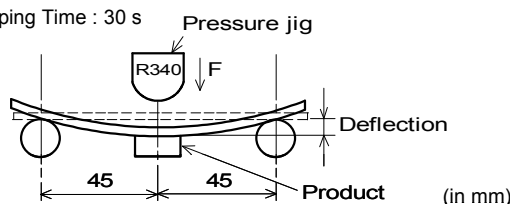
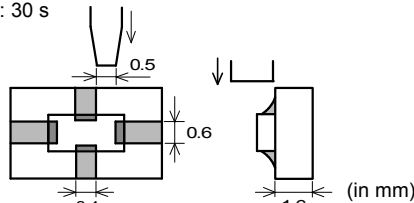
No	Item	Specification	Test Method										
1	Appearance and Dimensions	Meet item 4.	Visual Inspection and measured with Slide Calipers or Micrometer.										
2	Solderability	Electrodes shall be at least 90% covered with new solder coating.	Flux : Ethanol solution of rosin, 25(wt)% Pre-heat : 150±10°C, 60 to 90s Solder : Sn-3.0Ag-0.5Cu Solder Temperature : 240 ± 3°C Immersion Time : 3±1 s Immersion and emersion rates : 25mm / s										
3	Resistance to soldering heat	Meet Table 1. <table border="1"> <thead> <tr> <th colspan="2">Table 1</th> </tr> </thead> <tbody> <tr> <td>Appearance</td> <td>No damaged</td> </tr> <tr> <td>Cap. Change</td> <td>Within ±7.5%</td> </tr> <tr> <td>I.R.</td> <td>Meet the initial rated value.</td> </tr> <tr> <td>Rdc 1,2</td> <td>22 to 2200pF 0.5 Ωmax. 22000pF 0.05 Ωmax.</td> </tr> </tbody> </table>	Table 1		Appearance	No damaged	Cap. Change	Within ±7.5%	I.R.	Meet the initial rated value.	Rdc 1,2	22 to 2200pF 0.5 Ωmax. 22000pF 0.05 Ωmax.	Flux : Ethanol solution of rosin, 25(wt)% Pre-heat : 150±10°C, 60 to 90s Solder : Sn-3.0Ag-0.5Cu Solder Temperature : 270 ± 5°C Immersion Time : 10 ± 1 s Immersion and emersion rates : 25mm / s Initial values : About 100 to 22000pF, measured after heat treatment (150+0 / -10 °C, 1hour) and exposure in the room condition for 48±4 hours. Then measured after exposure in the room condition for following hours. 22 to 47pF : 24±2 hours 100 to 22000pF : 48±4 hours
Table 1													
Appearance	No damaged												
Cap. Change	Within ±7.5%												
I.R.	Meet the initial rated value.												
Rdc 1,2	22 to 2200pF 0.5 Ωmax. 22000pF 0.05 Ωmax.												
4	Bending Strength	Meet Table 2. <table border="1"> <thead> <tr> <th colspan="2">Table 2</th> </tr> </thead> <tbody> <tr> <td>Appearance</td> <td>No damaged</td> </tr> <tr> <td>Cap. Change</td> <td>Within ±7.5%</td> </tr> <tr> <td>Rdc 1,2</td> <td>22 to 2200pF 0.5 Ωmax. 22000pF 0.05 Ωmax.</td> </tr> </tbody> </table>	Table 2		Appearance	No damaged	Cap. Change	Within ±7.5%	Rdc 1,2	22 to 2200pF 0.5 Ωmax. 22000pF 0.05 Ωmax.	It shall be soldered on the glass-epoxy substrate(t = 1.0mm). Deflection : 2 mm Keeping Time : 30 s 		
Table 2													
Appearance	No damaged												
Cap. Change	Within ±7.5%												
Rdc 1,2	22 to 2200pF 0.5 Ωmax. 22000pF 0.05 Ωmax.												
5	Drop	Products shall be no failure after tested.	It shall be dropped on concrete or steel board. Method : Free fall Height : 1 m Attitude from which the product is dropped : 3 directions The Number of Time : 3 times for each direction (Total 9 times)										
6	Bonding Strength	The electrodes shall be no failure after tested.	It shall be soldered on the glass-epoxy substrate. Applying Force (F) : 9.8 N Applying Time : 30 s 										
7	Vibration	Meet Table 3. <table border="1"> <thead> <tr> <th colspan="2">Table 3</th> </tr> </thead> <tbody> <tr> <td>Appearance</td> <td>No damaged</td> </tr> <tr> <td>Capacitance</td> <td>Meet the initial rated value.</td> </tr> <tr> <td>Rdc 1,2</td> <td>22 to 2200pF 0.5 Ωmax. 22000pF 0.05 Ωmax.</td> </tr> </tbody> </table>	Table 3		Appearance	No damaged	Capacitance	Meet the initial rated value.	Rdc 1,2	22 to 2200pF 0.5 Ωmax. 22000pF 0.05 Ωmax.	It shall be soldered on the glass-epoxy substrate. Oscillation Frequency : 10 to 2000 to 10Hz for 20 minutes. Total amplitude 1.5 mm or Acceleration amplitude 196m/s ² whichever is smaller. Time : A period of 2 hours in each of 3 mutually perpendicular directions. (Total 6 hours) Initial values : About 100 to 22000pF, measured after heat treatment (150+0 / -10 °C, 1hour) and exposure in the room condition for 48±4 hours. Then measured after exposure in the room condition for following hours. 22 to 47pF : 24±2 hours 100 to 22000pF : 48±4 hours		
Table 3													
Appearance	No damaged												
Capacitance	Meet the initial rated value.												
Rdc 1,2	22 to 2200pF 0.5 Ωmax. 22000pF 0.05 Ωmax.												

■ SPECIFICATIONS AND TEST METHODS

Environment Performance

It shall be soldered on the glass-epoxy substrate.

No	Item	Specification	Test Method														
1	Temperature Cycling	Meet Table 1.	<p>1 Cycle</p> <p>1 step : -55+0 / -3°C / 30+3 / -0 min</p> <p>2 step : Room Temperature / within 3 min</p> <p>3 step : +125+3 / -0°C / 30+3 / -0 min</p> <p>4 step : Room Temperature / within 3 min</p> <p>Total of 10 cycles</p> <p>Initial values : About 100 to 22000pF, measured after heat treatment(150+0 / -10°C,1hour) and exposure in the room condition for 48±4 hours.</p> <p>Then measured after exposure in the room condition for following hours.</p> <p style="padding-left: 40px;">22 to 47pF : 24±2 hours</p> <p style="padding-left: 40px;">100 to 22000pF : 48±4 hours</p> <p>About 100 to 22000pF, If it's doubt, measured after heat treatment (150+0 / -10 °C,1hour) and exposure in the room condition for 48±4 hours.</p>														
2	Humidity	<p>Meet Table 4.</p> <p><u>Table 4</u></p> <table border="1" style="width: 100%;"> <tr> <td>Appearance</td> <td colspan="2">No damaged</td> </tr> <tr> <td>Cap. Change</td> <td colspan="2">Within ±12.5%</td> </tr> <tr> <td>I.R.</td> <td colspan="2">Meet the initial rated value.</td> </tr> <tr> <td rowspan="2">Rdc 1,2</td> <td>22 to 2200pF</td> <td>0.5 Ωmax.</td> </tr> <tr> <td>22000pF</td> <td>0.05 Ωmax.</td> </tr> </table>	Appearance	No damaged		Cap. Change	Within ±12.5%		I.R.	Meet the initial rated value.		Rdc 1,2	22 to 2200pF	0.5 Ωmax.	22000pF	0.05 Ωmax.	<p>Temperature : 40±2°C</p> <p>Humidity : 90 to 95%(RH)</p> <p>Time : 500+24 / -0 hours</p> <p>Initial values : About 100 to 22000pF,measured after heat treatment (150+0 / -10 °C,1hour), and exposure in the room condition for 48±4 hours.</p> <p>Then measured after exposure in the room condition for following hours.</p> <p style="padding-left: 40px;">22 to 47pF : 24±2 hours</p> <p style="padding-left: 40px;">100 to 22000pF : 48±4 hours</p> <p>About 100~22000pF, If it's doubt, measured after heat treatment (150+0 / -10 °C,1hour) and exposure in the room condition for 48±4 hours.</p>
Appearance	No damaged																
Cap. Change	Within ±12.5%																
I.R.	Meet the initial rated value.																
Rdc 1,2	22 to 2200pF	0.5 Ωmax.															
	22000pF	0.05 Ωmax.															
3	Heat Life		<p>Temperature : 125±2°C</p> <p>Test Voltage : Rated Voltage x 200%</p> <p>Charge Current : 50 mA max.</p> <p>Time : 1000+48 / -0 hours</p> <p>Initial values : About 100 to 22000pF,measured after voltage treatment (Maximum Operating Temperature±2°C, Rated Voltage x 200%, 1hour) and exposure in the room condition for 48±4 hours.</p> <p>Then measured after exposure in the room condition for following hours.</p> <p style="padding-left: 40px;">22 to 47pF : 24±2 hours</p> <p style="padding-left: 40px;">100 to 22000pF : 48±4 hours</p>														
4	Cold Resistance		<p>Temperature : -55±2°C</p> <p>Time : 500+24 / -0 hours</p> <p>Initial values : About 100 to 22000pF,measured after heat treatment (150+0 / -10 °C,1hour), and exposure in the room condition for 48±4 hours.</p> <p>Then measured after exposure in the room condition for following hours.</p> <p style="padding-left: 40px;">22 to 47pF : 24±2 hours</p> <p style="padding-left: 40px;">100 to 22000pF : 48±4 hours</p> <p>About 100 to 22000pF, If it's doubt, measured after heat treatment (150+0 / -10 °C,1hour) and exposure in the room condition for 48±4 hours.</p>														

1. Appearance and Dimensions (8mm-wide paper tape)

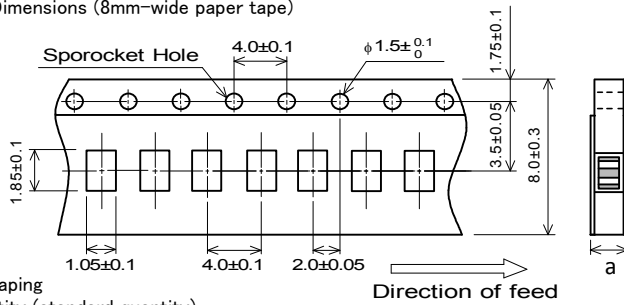

Chip thickness (T)	Dimension (a)
0.8	1.1max
0.6	0.9max

(in mm)

2. Specification of Taping

- (1) Packing quantity (standard quantity)
4000 pcs. / reel
- (2) Packing Method
Products shall be packaged in the cavity of the base tape and sealed by top tape and bottom tape.
- (3) Sprocket Hole
The sprocket holes are to the right as the tape is pulled toward the user.
- (4) Base tape and Top tape
The base tape and top tape have no spliced point.
- (5) Cavity
There shall not be burr in the cavity.
- (6) Missing components number
Missing components number within 0.1% of the number per reel or 1 pc., whichever is greater, and are not continuous.
The specified quantity per reel is kept.

3. Pull Strength of Top Tape

5Nmin.(※Only for NFM18PS, 8Nmin.)

4. Peeling off force of top tape

0.1N to 0.6N (minimum value is typical) 165 to 180 degree
Speed of Peeling off : 300 mm / min

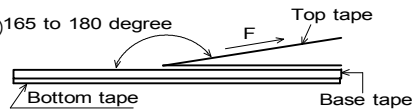

5. Dimensions of Leader-tape, Trailer and Reel

There shall be leader-tape (top tape and empty tape) and trailer-tape (empty tape) as follows.

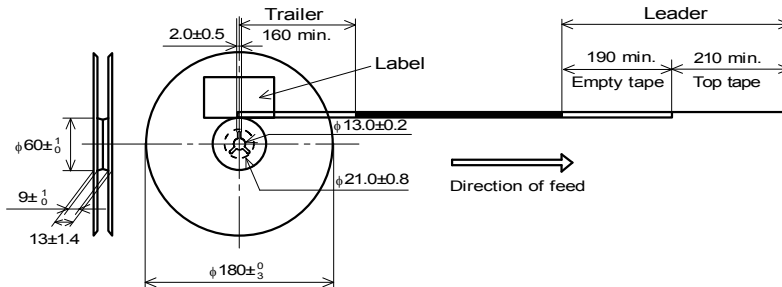

(in mm)

1. Mounting density

Add special attention to radiating heat of products when mounting this product near the products with heating. The excessive heat by other products may cause deterioration of insulation resistance and excessive heat at this product, resulting in a fire.

2. Limitation of Applications

Please contact us before using our products for the applications listed below which require especially high reliability for the prevention of defects which might directly cause damage to the third party's life, body or property.

- (1)Aircraft equipment (2)Aerospace equipment (3)Undersea equipment (4)Power plant control equipment
- (5)Medical equipment (6)Transportation equipment(automobiles, trains, ships, etc.) (7)Traffic signal equipment
- (8)Disaster prevention / crime prevention equipment (9)Data-processing equipment
- (10)Applications of similar complexity or with reliability requirements comparable to the applications listed in the above

Products can only be soldered with reflow.
 This product is designed for solder mounting.
 Please consult us in advance for applying other mounting method such as conductive adhesive.

1. Flux and Solder

Flux	Use rosin-based flux, Do not use highly acidic flux (with chlorine content exceeding 0.2(wt)%). Do not use water-soluble flux. Other flux (except above) Please contact us for details, then use.
Solder	Use Sn-3.0Ag-0.5Cu solder Use of Sn-Zn based solder will deteriorate performance of products. In case of using Sn-Zn based solder, please contact Murata in advance.

2. Note for Assembling

< Thermal Shock >

Pre-heating should be in such a way that the temperature difference between solder and products surface is limited to 100°C max. Also cooling into solvent after soldering should be in such a way that the temperature difference is limited to 100°C max.

3. Attention Regarding P.C.B. Bending

The following shall be considered when designing P.C.B.'s and laying out products.

(1) P.C.B. shall be designed so that products are not subject to the mechanical stress for board warpage.
 [Products direction]

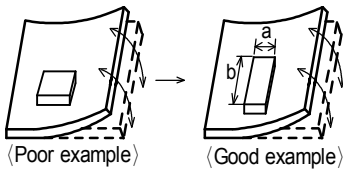

Products shall be located in the sideways direction (Length:a<b) to the mechanical stress.

(2) Products location on P.C.B. near seam for separation.

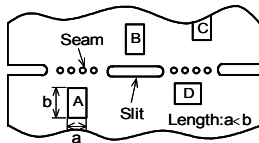

Products (A,B,C,D) shall be located carefully so that products are not subject to the mechanical stress due to warping the board. Because they may be subjected the mechanical stress in order of $A > C > B \approx D$.

4.Pre-heating Temperature

Soldering shall be handled so that the difference between pre-heating temperature and solder temperature shall be limited to 100°C max. to avoid the heat stress for the products.

5.Reflow Soldering

1) Soldering paste printing for reflow

- Standard thickness of solder paste: 100µm to 150µm.
- Use the solder paste printing pattern of the right pattern.
- For the resist and copper foil pattern, use standard land dimensions.

• Standard printing pattern of solder paste.

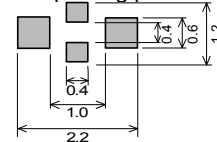

(in mm)

2) Soldering Conditions

Standard soldering profile and the limit soldering profile is as follows.

The excessive limit soldering conditions may cause leaching of the electrode and / or resulting in the deterioration of product quality.

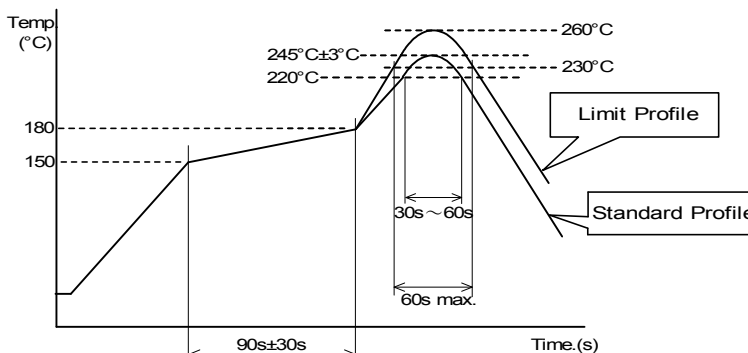

	Standard Profile	Limit Profile
Pre-heating	150°C ~ 180°C , 90s ± 30s	
Heating	above 220°C , 30s ~ 60s	above 230°C , 60s max.
Peak temperature	245°C ± 3°C	260°C , 10s
Cycle of reflow	2 times	2 times

6. Reworking with Soldering iron

The following conditions shall be strictly followed when using a soldering iron.

- Pre-heating : 150°C, 1 min
- Soldering iron output : 30W max.
- Tip temperature : 350°C max.
- Tip diameter : φ3mm max.
- Soldering time : 3(+1,-0) s
- Times : 2times max.

Note: Do not directly touch the products with the tip of the soldering iron in order to prevent the crack on the ceramic material due to the thermal shock.

7. Solder Volume

Solder shall be used not to be exceeded as shown below.

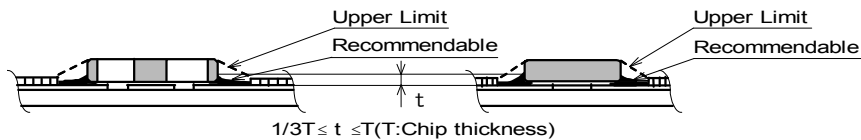

Accordingly increasing the solder volume, the mechanical stress to product is also increased. Excessive solder volume may cause the failure of mechanical or electrical performance.

8. Cleaning Conditions

Products shall be cleaned on the following conditions.

- (1) Cleaning temperature shall be limited to 60°C max. (40°C max. for Isopropyl alcohol (IPA))
- (2) Ultrasonic cleaning shall comply with the following conditions, with avoiding the resonance phenomenon at the mounted products and P.C.B.

- Power : 20W / l max.
- Frequency : 28kHz to 40kHz
- Time : 5 minutes max.

(3) Cleaner

1. Cleaner
Isopropyl alcohol (IPA)
2. Aqueous agent
PINE ALPHA ST-100S

(4) There shall be no residual flux and residual cleaner after cleaning.

In the case of using aqueous agent, products shall be dried completely after rinse with de-ionized water in order to remove the cleaner.

(5) Other cleaning
Please contact us.

9. Operating Environment

Do not use this product under the following environmental conditions, on deterioration of the performance, such as insulation resistance may result from the use.

- (1) in the corrodible atmosphere (acidic gases, alkaline gases, chlorine, sulfur gases, organic gases and etc.)
- (2) in the atmosphere where liquid such as organic solvent, may splash on the products.
- (3) in the atmosphere where the temperature / humidity changes rapidly and it is easy to dew.

10. Resin coating

The capacitance value may change and/or it may affect on the product's performance due to high cure-stress of resin to be used for coating / molding products. So please pay your careful attention when you select resin. In prior to use, please make the reliability evaluation with the product mounted in your application set.

11. Handling of a substrate

After mounting products on a substrate, do not apply any stress to the product caused by bending or twisting to the substrate when cropping the substrate, inserting and removing a connector from the substrate or tightening screw to the substrate. Excessive mechanical stress may cause cracking in the product.

Bending

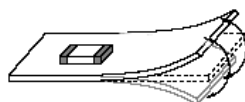

Twisting

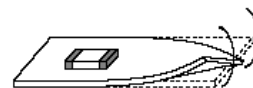

12. Standard Land Dimensions

The chip EMI filter suppresses noise by conducting the high-frequency noise element to ground. Therefore, to get enough noise reduction, feed through holes which is connected to ground-plane should be arranged according to the figure to reinforce the ground-pattern.

- < Standard land dimensions for reflow >
 ·Side on which chips are mounted

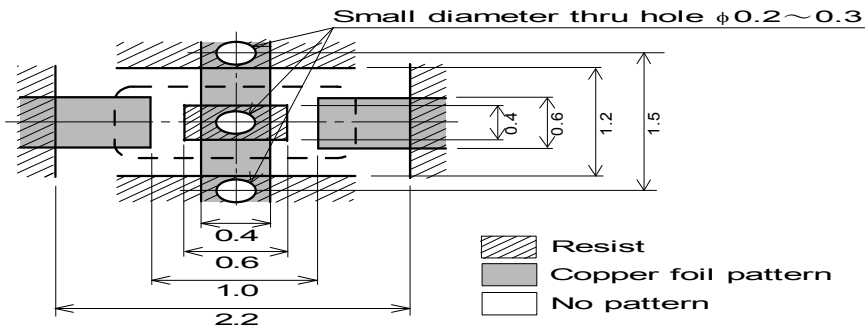

(in mm)

13. Storage condition

(1) Storage period

Use the products within 12 months after delivered.
 Solderability should be checked if this period is exceeded.

(2) Storage environment condition

- Products should be stored in the warehouse on the following conditions.
 - Temperature: -10 to $+40^{\circ}\text{C}$
 - Humidity: 15 to 85% relative humidity
 - No rapid change on temperature and humidity
- Don't keep products in corrosive gases such as sulfur, chlorine gas or acid, or it may cause oxidization of electrode, resulting in poor solderability.
- Products should be stored on the palette for the prevention of the influence from humidity, dust and so on.
- Products should be stored in the warehouse without heat shock, vibration, direct sunlight and so on.
- Products should be stored under the airtight packaged condition.

(3) Delivery

Care should be taken when transporting or handling product to avoid excessive vibration or mechanical shock.

- (1) Please make sure that your product has been evaluated in view of your specifications with our product being mounted to your product.
- (2) You are requested not to use our product deviating from the agreed specifications.
- (3) We consider it not appropriate to include any terms and conditions with regard to the business transaction in the product specifications, drawings or other technical documents. Therefore, if your technical documents as above include such terms and conditions such as warranty clause, product liability clause, or intellectual property infringement liability clause, they will be deemed to be invalid.

单击下面可查看定价，库存，交付和生命周期等信息

[>>Murata\(村田\)](#)