



FEATURES

- Large (0.4"/10.2mm), enhanced-contrast, LCD display
- Single +5V supply or 9V battery
- Power as low as 3.2mW
- Miniature size:
2.17" x 0.92" x 0.43" (55mm x 23mm x 11mm)
- Epoxy-encapsulated, 12-pin DIP
- Backlit displays optional
- 4 differential input voltage ranges
- High accuracy, ±1 count (±0.05%)
- Autopolarity changeover and overrange indication
- User-selectable decimal point placement
- Numerous "plug-on" application boards
- 0 to +60°C temperature range

Offering all the outstanding features and benefits of Murata Power Solutions' industry leading DMS-20LCD Series of 3½ Digit LCD Panel Meters, DMS-30LCD meters offer larger, more easily readable displays at slightly higher power consumptions. Like all DMS Series LCD meters, these miniature (2.17" x 0.92" x 0.43"), epoxy-encapsulated devices offer component-like ease-of-use, outstanding reliability and easy installation in either panels or pc-cards.

DMS-30LCD devices operate from a single +5V supply or a 9V battery. Battery-operated units typically draw 350µA and consume a mere 3.2mW. Backlit models are available for low-light applications; though we have found many designers prefer Murata Power Solutions' unique low-power LED meters in those circumstances.

Offering 4 optional input voltage ranges (±200mV, ±2V, ±20V or ±200V), DMS-30LCD meters have an extremely user-friendly input structure. They can be used in differential or single-ended modes. Input impedance is a minimum 800kΩ. CMRR is typically 86dB. CMV is ±2V, and inputs are overvoltage protected to ±100V.

Each meter incorporates an extremely stable, double regulated reference and is fully calibrated at our factory prior to encapsulation. We guarantee outstanding initial accuracy (±1 count) and excellent stability over temperature (±0.15 counts/°C). These extremely rugged meters are moisture and vibration proof and never require adjustment or recalibration.

For popular applications (4-to-20mA, rms-to-dc conversion, ac line power, J and K thermocouples, etc.), the DMS-30LCD Series includes a complete line of "plug-on" application boards that conveniently convert your meter into an application-specific instrument.

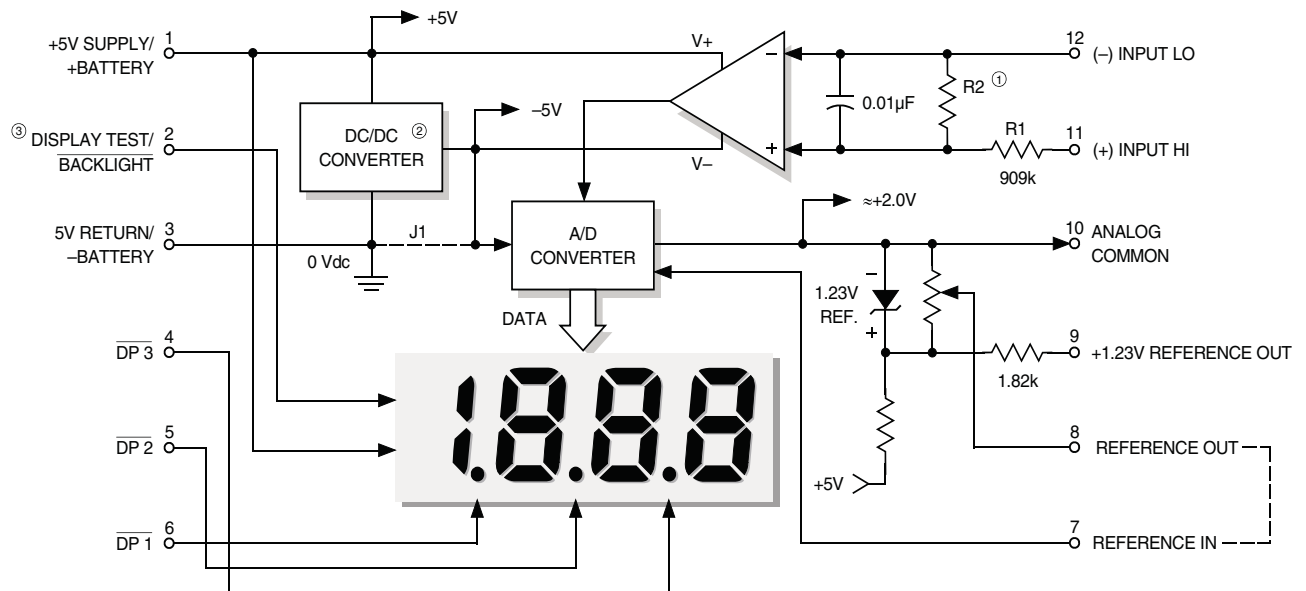

For full details go to www.murata-ps.com/rohs

① R2 is not used on ±200mV (-0) models or ±2V (-1) models. R2 = 100k on ±20V (-2) models and 9.1k on ±200V (-3) models.

② DC/DC converter is not used on 9V-powered models, J1 is connected.

③ Display Test function is not available on backlit models.

Performance/Functional Specifications

Typical at T_A = +25°C and supply voltage = +5V (using the single-ended input circuit) or +9V (using the differential input circuit), unless otherwise noted.

Analog Inputs	Min.	Typ.	Max.	Units
Full Scale Input Range:				
DMS-30LCD-0	–	±200	–	mV
DMS-30LCD-1	–	±2	–	Volts
DMS-30LCD-2	–	±20	–	Volts
DMS-30LCD-3	–	±200	–	Volts
Input Impedence:				
DMS-30LCD-0, -1	100	1000	–	MΩ
DMS-30LCD-2, -3	0.8	1	–	MΩ
Overvoltage Protection ①				
DMS-30LCD-0, -1, -2	–	–	±100	Volts
DMS-30LCD -3	–	–	±250	Volts
Common Mode Voltage Range ②				
	–	–	±2	Volts
CMRR (dc to 60Hz)				
	–	86	–	dB
Control Inputs ③				
Decimal Pt. Placement (Pins 4-6): Functionality Logic Compatibility	Tie to pin 3 to activate TTL (on 5V-powered models)			
Display Test (Pin 2)	Tie to pin 1 to activate			
Backlight (Pin 2)	Tie to pin 3 to turn on backlight			
Performance				
Sampling Rate	2.5 reading per second			
Accuracy (1 minute warm-up):				
DMS-30LCD-0 (Vin = +0.19V)	–	±1	±2	Counts
DMS-30LCD-1 (Vin = +1.9V)	–	±1	±2	Counts
DMS-30LCD-2 (Vin = +19V)	–	±2	±3	Counts
DMS-30LCD-3 (Vin = +190V)	–	±2	±3	Counts
Zero Reading (Vin = 0 Volts)	"–001"	"000"	"001"	
Temperature Drift (0 = +60°C)	–	±0.2	±0.4	Cnts/°C
+1.23V Reference Out (Pin 9)	+1.20	+1.23	+1.25	Volts
Power Supply Requirements (5V Models)				
Supply Voltage	+4.75	+5.00	+5.25	Volts
Supply Current:				
Standard Models	–	800	1200	µA
Backlit Models	–	45	60	mA
Power Supply Requirements (9V Models)				
Supply Voltage	+7.5	+9.00	+14.0	Volts
Supply Current:				
Standard Models	–	350	600	µA
Backlit Models	–	45	60	mA
Display				
Display Type and Size	3½ digit, 0.4"/10.2mm high LCD			
Polarity Indication	Autopolarity ("–" for negative Vin)			
Overrange Indication	"–1 ___" for negative inputs "1 ___" for positive inputs			

Physical/Environmental				
Operating Temperature	0	–	+60	°C
Storage Temperature	–20	–	+75	°C
Humidity (non-condensing)	0	–	95	%
Case Material	Polycarbonate			
Weight	0.75 ounces (21 grams)			

- ① Applies for transient or continuous overvoltages applied to (+) INPUT HI (pin 11) with (–) INPUT LO (pin 12) properly connected. Pin 12 is not overvoltage protected (see Figure 1). Voltages applied to pin 12 should not exceed the supply voltage.
- ② Listed spec applies to 5V-powered models only. For 9V-powered models, both (–) INPUT LO (pin 12) and (+) INPUT HIGH (pin 11) must always be at least 1.5V above –BATTERY (pin 3) and at least 1.5V below +BATTERY (pin 1).
- ③ See Technical Notes.

Ordering Information

DMS-30LCD - 1 - 5 - C

Input Range:

- 0 = ±200mV
- 1 = ±2V
- 2 = ±20V
- 3 = ±200V

Power Source:

- 5 = +5V
- 9 = +9V

Add -C for RoHS

Leave blank for standard models.

Add B for backlit models.

See www.murata-ps.com/dpm-availability for model-specific availability.

Accessories:

- DMS-30-CP Panel cutout punch
- DMS-BZL1-C DMS-30 bezel assembly
- DMS-BZL2-C DMS-30 bezel assembly with sealing gasket

Add-On Application Boards:

- DMS-EB-C Multi-purpose (gain/offset, 4-20mA, etc.)
- DMS-EB-DC/DC-C Provides isolated +5V power
- DMS-EB-RMS-C For true rms measurements of ac voltages
- DMS-EB-AC/DC-C For ac line-powered applications

A panel-mount retaining clip is supplied with each model.

TECHNICAL NOTES

1. **+1.23V REFERENCE OUTPUT (Pin 9):** This pin is the output of the meter's precision +1.23V internal reference, and it is referenced to ANALOG COMMON (pin 10) which sits at a potential of approximately +2V. This output should be buffered if used to drive external loads since sourcing more than 15µA from pin 9 can affect both the initial accuracy and temperature drift of the meter.
2. **ANALOG COMMON (Pin 10):** This pin is connected to an internal, low-noise, "relative" ground. It is used in certain differential and "floating" measurements as described in the Applications section of this data sheet and Ap Note DMS-AN3 at <http://www.murata-ps.com/data/meters/dms-an3.pdf>. **Pin 10 should not be connected to pin 3 (5V RETURN/–BATTERY) or to your system's analog ground.**

- Decimal Point Placement:** The location of the decimal point is user-selectable, and the decimal point control pins (DP1-DP3) are active low functions. Select the appropriate decimal point by tying the appropriate pin (pin 4, 5 or 6) to pin 3 (5V RETURN/–BATTERY). Unused decimal point location pins should be left open. For 5V-powered models, the decimal location pins are TTL compatible and may be hard wired as described above or driven with 5V TTL logic gates.
- REFERENCE OUTPUT (Pin 8) and INPUT (Pin 7):** Pin 8 is a precision reference actively trimmed at the factory. In normal operation, pin 8 must be tied to pin 7 to achieve all listed accuracy and drift specifications.
- DISPLAY TEST (Pin 2):** (Not available on backlit models) Connect DISPLAY TEST (pin 2) to +5V SUPPLY/+BATTERY (pin 1) to activate. All LCD segments, exclusive of the decimal points, will be momentarily enabled. **Do not leave the unit in the TEST mode for more than 10 seconds as this will damage the LCD segments.**
- BACKLIGHT (Pin 2) Function:** For backlit models, grounding pin 2 (i.e. connecting it to pin 3) turns on the backlighting LED's. 9V-powered backlit models function with supply voltages up to +14V, however, activating the backlight with voltages greater than 9.2V can damage the meter. Therefore, a 1/4 Watt series resistor must be installed between pins 3 and 2 in these situations. The value of the series resistor is determined using the following formula:

$$R_{\text{Series}} = \frac{+BATTERY - 9.2V}{0.035} \text{ Ohms}$$

Example: If +BATTERY (pin 1 with respect to pin 3) is +12.6V,

$$R_{\text{Series}} = \frac{+12.6 - 9.2V}{0.035} \text{ Ohms}$$

$$R_{\text{Series}} = 97 \text{ Ohms}$$

In any backlit application, including those with supply voltages < 9.2V, the current drawn by the backlight (and therefore the current drawn by the meter) can be reduced by installing a 1/4 Watt resistor between pins 3 and 2. The brightness of the backlight will be reduced proportionately.

- Gain Adjust:** There is a gain-adjust potentiometer on the back of each meter. It has approximately ±50 counts (±2.5%) of adjustment range. Since these devices essentially have no zero/offset errors, a gain adjustment is effectively an overall accuracy adjustment. Though they may be performed at any point (except zero), accuracy adjustments are most effective when performed with higher level input signals. Refer to Figure 9 for applications requiring greater (±10%) gain adjustments.

- Soldering Methods:** All models in the DMS-30LCD Series easily withstand most common wave soldering operations. We recommend, however, you evaluate the effects your particular soldering techniques may have on the meter's plastic case and high-precision electrical performance. We recommend the use of no-clean lead-free solders.

9. Suggested Mating Connectors:

Panel mounted:

Connector housing	Murata Power Solutions P/N 4320-01069-0
Terminal type	Murata Power Solutions P/N 4400-01032-0
Wire size	22 to 26 AWG
Insulation diameter	0.062" (1.57mm) maximum
Stripping length	0.100 to 0.125" (2.54 to 3.17mm)

Board mounted:

Socket	Murata Power Solutions P/N 4320-01074-0
--------	---

APPLICATIONS

DMS-30LCD meters are available in either 5V-powered or 9V-powered models. 9V devices operate directly from 7.5V to 14V supplies (usually batteries) without the need for external voltage regulators. 9V devices, however, can not be used to measure voltages referenced to the negative battery terminal (pin 3) because the minus input to the meter (pin 12, (–) INPUT LO) must always be at least 1.5V above pin 3. 9V-powered meters can only be used to make differential and not single-ended measurements. 5V-powered devices operate from any well-regulated +5V supply and will accurately measure voltages both above and below pin 3 (5V RETURN) in either single-ended or differential configurations.

- Single-Ended Input Configurations:** True single-ended measurements can only be made with 5V-powered meters. The circuit of Figure 2 avoids problems normally associated with ground-loop currents. Separate ground runs should be used for 5V RETURN (pin 3) and (–) INPUT LO (pin 12).

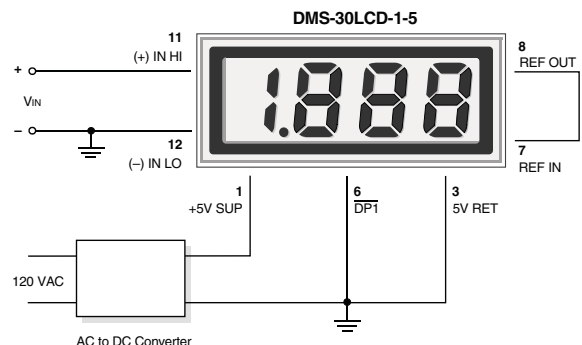

Figure 2. Single-Ended Input Configuration (5V-Powered Models)

APPLICATIONS

2. Differential Input Configurations: Differential measurements can be made with either 5V-powered or 9V-powered meters. Figure 3, though not a practical real-world application, uses a voltage divider to demonstrate the concept of a differential input signal. Be careful not to exceed the ±2V common mode voltage limitation for 5V-powered meters.

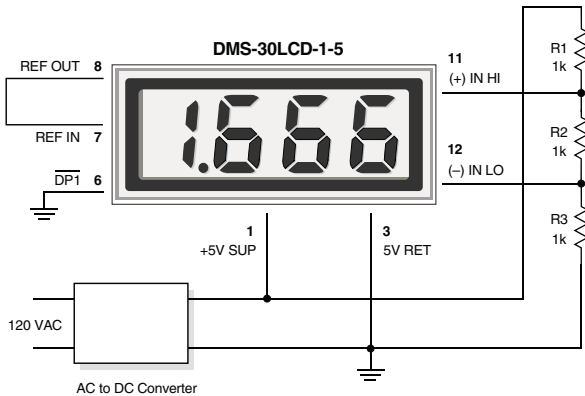

Figure 3. Differential Input Configuration (5V-Powered Models)

3. Engineering Scaling: For measuring voltages greater than the full scale input range of a given meter, the input signal must be attenuated. A simple voltage divider (similar to that shown in Figure 4) will scale the input to within the range of the selected meter. R1 and R2 should be precision, ±1%, metal-film resistors with absolute TCR's less than 50ppm/°C. See Ap Note 4 for more information on engineering scaling.

$$50k\Omega < R1 + R2 < 10M\Omega$$

$$\frac{R2}{R1 + R2} \times V_{IN} = \text{Reading}$$

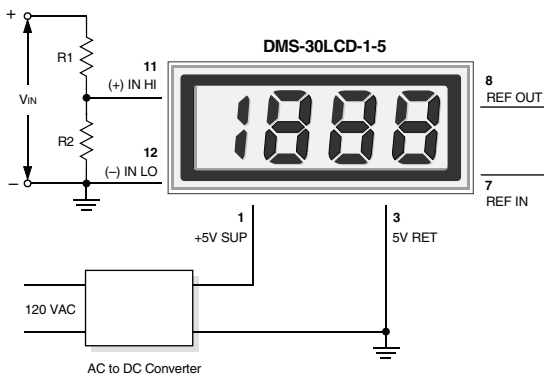

Figure 4. Input Attenuation Circuit

4. Floating Signal Source Measurements: Floating signals can be measured using the circuits shown in Figures 5 and 6. Figure 5 uses a 5V-powered meter. Figure 6 uses a 9V-powered meter. Connecting pin 10 (ANALOG COMMON) to (-) INPUT LO (pin 12) provides the reference point for the meter's input.

A "floating" input is a signal that has no galvanic connection to the meter's power supply. In the figures below, the 1.5V battery illustrates a true floating input.

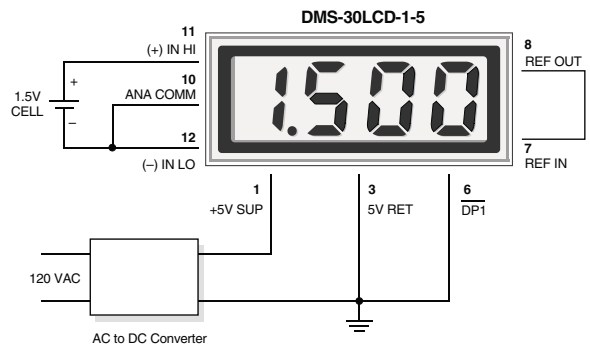

Figure 5. Floating Input Measurements (5V-Powered Models)

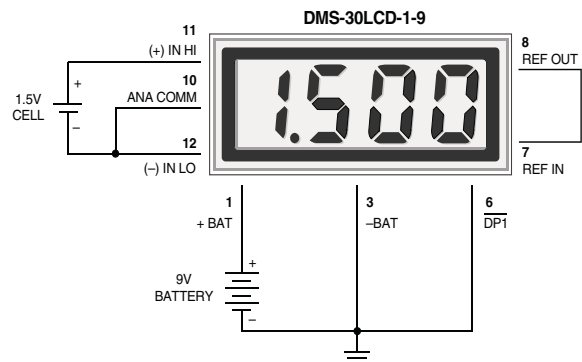

Figure 6. Floating Input Measurements (9V-Powered Models)

5. Process Control (4-to-20mA) Measurements: In many common process-control applications, a 4-to-20mA current loop is used to transmit information. Because DMS-30LCD meters have such high input impedance, a simple shunt resistor across the meter's input can be used to convert the loop current to a voltage. See Figure 7. The value of the shunt resistor is a function of the scaling requirements of the particular application and can be calculated using the following equation:

MECHANICAL DIMENSIONS: Inches (mm)

TOLERANCES: 2 PL DEC ±0.02 (±0.51)
3 PL DEC ±0.010 (±0.254)

LEAD DIMENSIONS: 0.025 (0.635) x 0.025 (0.635) NOMINAL

RECOMMENDED PC BOARD FINISHED HOLE DIAMETER:
0.042 ±0.003 (1.067 ±0.076)

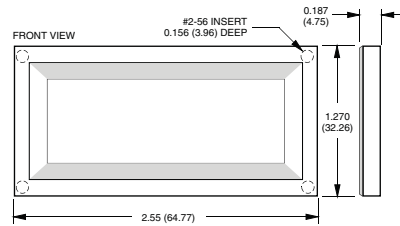
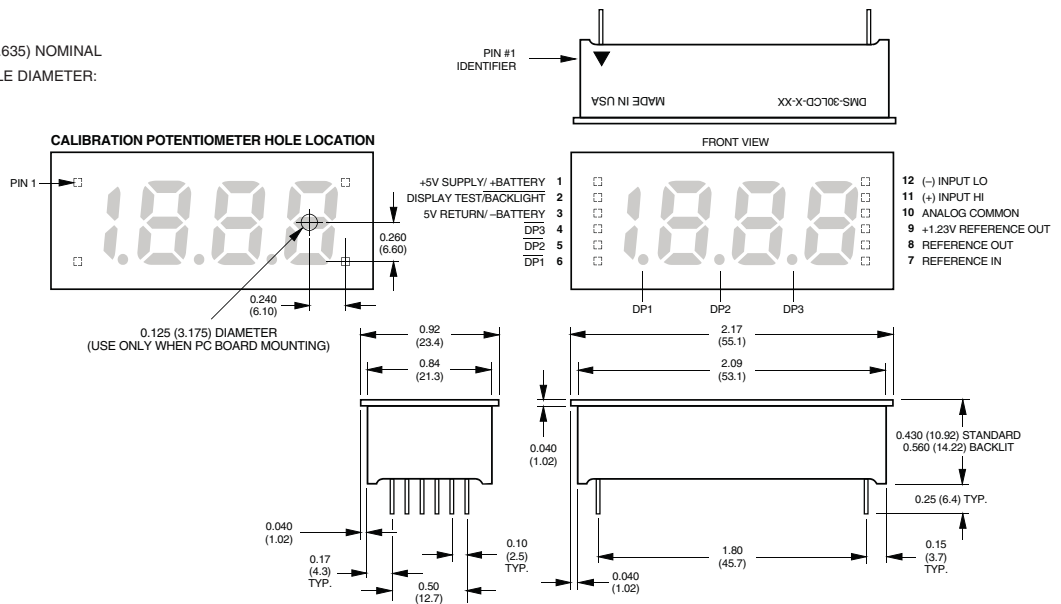

RECOMMENDED DRILL AND PANEL CUTOUT DIMENSIONS

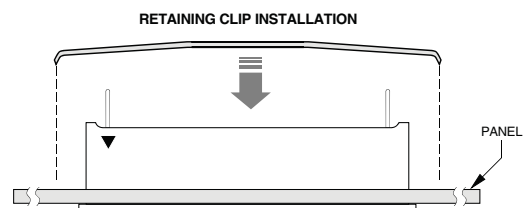
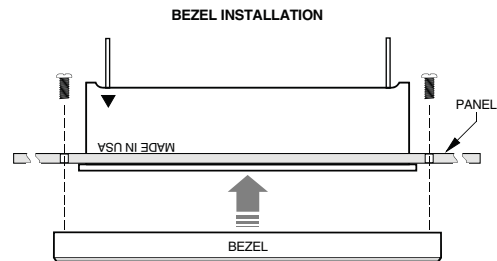
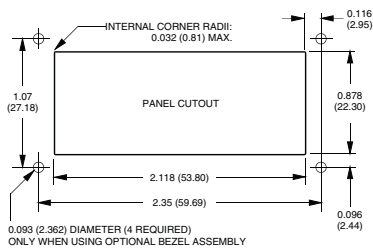

Murata Power Solutions, Inc.
11 Cabot Boulevard, Mansfield, MA 02048-1151 U.S.A.
ISO 9001 and 14001 REGISTERED



This product is subject to the following operating requirements and the Life and Safety Critical Application Sales Policy:
Refer to: <http://www.murata-ps.com/requirements/>

Murata Power Solutions, Inc. makes no representation that the use of its products in the circuits described herein, or the use of other technical information contained herein, will not infringe upon existing or future patent rights. The descriptions contained herein do not imply the granting of licenses to make, use, or sell equipment constructed in accordance therewith. Specifications are subject to change without notice. © 2015 Murata Power Solutions, Inc.

单击下面可查看定价，库存，交付和生命周期等信息

[>>Murata\(村田\)](#)