



FEATURES

- Loop-powered, no power supply required!
- 2.9V typical loop-drop; 190-Ohm (max.) loop impedance
- Dip-switch-selectable range, offset, and decimal points
- Hundreds of different input/readout combinations
- Non-interacting gain (span) and offset (zero) 20-turn potentiometers
- Large, 0.40" (10.0mm) high, sunlight-viewable LCD digits
- Miniature size: 2.17" x 0.92" x 0.90" (55mm x 23mm x 23mm)
- Vibration-resistant package; reliable screw-terminal connections
- 100% soldered connections

The DMS-40LCD-4/20S's ultra-low 2.9V typical loop-drop (190-Ohm burden) makes it ideal for use in 4-20mA process monitoring applications which have two or more series-connected loop-monitoring devices. The low loop-burden means it can be used in current loops that are powered from supply voltages as low as +8Vdc! The DMS-40LCD-4/20S is self-powered; all required operating power is derived directly from the current loop itself. It requires no separate dc power supply or special grounding considerations and can be connected ANYWHERE in the loop!

The DMS-40LCD-4/20S's input, span, and offset circuits all employ super-stable, $\pm 0.5\%$ thin-film chip resistors. Long-term stability and accuracy are assured by driving these tight-tolerance resistors with an ultra-stable, $\pm 0.2\%$ band-gap voltage reference. Unlike many competitor's designs, the two precision 20-turn span and zero adjust potentiometers do not interact with one another. Its full-size, 0.40" (10.0mm) high-contrast 4½ digit LCD display offers 19,999 counts of resolution and can be read in virtually any lighting condition—including full sunlight!

All range-change and decimal point selections are made by configuring two gold-plated, vibration-resistant, six-position DIP switches. The two connections to the current loop are made via a reliable, screw-type terminal block. To further enhance reliability, the design features 100% soldered connections—no troublesome zebra/elastomeric connectors are used. All these outstanding features make the DMS-40LCD-4/20S the highest quality, most rugged, 4½ digit, LCD-display process monitor available.

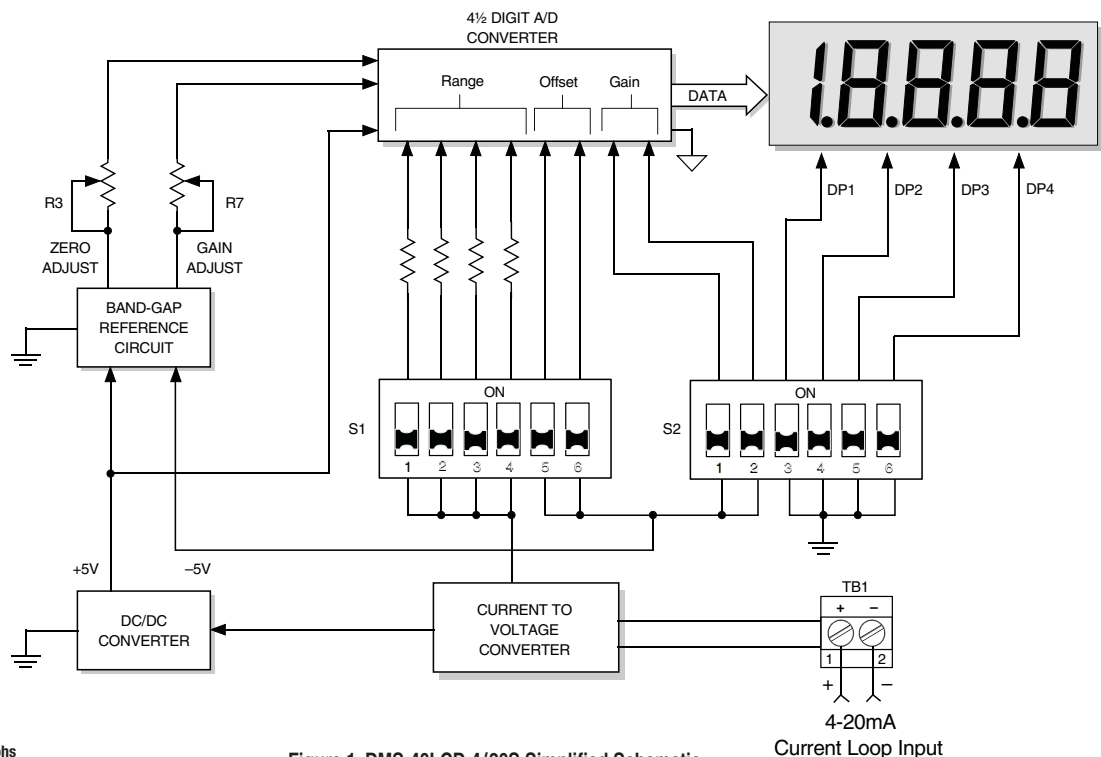

Figure 1. DMS-40LCD-4/20S Simplified Schematic



Performance/Functional Specifications

Typical at TA = +25°C, unless otherwise noted.

Current Loop Input	Min.	Typ.	Max.	Units
Full Scale Input Range (1)	+3.8	–	+20.4	mA
Loop Burden(2)	–	–	190	Ohms
Voltage Drop (2)	–	2.9	3.8	Volts
Overcurrent Protection	–	–	±40	mA
Performance				
Sampling Rate	2.5 reading per second			
Accuracy (1 minute warm-up)	±0.05%FS ±1 Count			
Temperature Drift of Span(3)	–	±0.3	±0.6	Cnts/°C
Temperature Drift of Zero(3)	–	±0.2	±0.5	Cnts/°C
Display				
Display Type and Size	4½ digit, 0.4"/10.2mm high LCD			
Polarity Indication	"–" for negative readings			
Overrange Indication	"–1 ___" for negative inputs "1 ___" for positive inputs			
Physical/Environmental				
Operating Temperature	0	–	+50	°C
Storage Temperature	–20	–	+75	°C
Humidity (non-condensing)	0	–	95	°C
Case Material	Polycarbonate			
Weight	0.1 ounces (28 grams)			

Ordering Information

DMS-40LCD-4/20S-C	4½ digit, LCD, loop-powered meter
DMS-BZL1-C	Panel-mount bezel assembly
DMS-BZL2-C	Panel-mount bezel assembly with sealing gasket
DMS-30-CP	Panel cutout punch

A panel-mount retaining clip is supplied with each meter.

TECHNICAL NOTES

(1) Full Scale Input: The Display readings shown in Table 1 can typically be obtained with transmitters having a low-level output of 3.8 to 4.3mA and a full-scale output of 19.4 to 20.4mA. When using a transmitter whose output falls outside these ranges and the desired display readings are close to the upper or lower adjustment limits of the selected DIP-switch setting #, try using the next highest DIP-switch setting # if, after adjusting R7, the display reading is still too low, or the next lowest setting # if the display reading is still too high (see example number 2). Please keep in mind that the DMS-40LCD meter from which the DMS-40LCD-4/20S is derived has an accuracy specification of ±3 counts (max.); thus, it may not always be possible to obtain the exact desired display readings. A change of ±1 count is defined as the right-hand most digit going up or down by one.

Display readings other than those shown in Table 1 are obtainable. For example, some negative readings with a 4mA input are possible.

Consult Murata Power Solutions for more information regarding display readings not shown in the table.

- (2) Max. Loop-Voltage Drop/Max. Loop impedance:** The maximum loop voltage-drop and maximum loop impedance (burden) are both specified with the meter configured for DIP-Switch setting #20 and an input loop current of 20.0mA.
- (3) Temperature Drift:** Temperature drift of zero and temperature drift of gain are both specified with the meter configured for range #20 with a 4mA input adjusted (using R3) to read "0000" ±1 count, and a 20mA input adjusted (using R7) to read "19000" ±2 counts at an initial ambient temperature of 25°C.

The temperature drift of gain is proportional to the selected full-scale range. It is typically less pronounced at the lower range settings, that is, if the observed gain drift of a particular meter is +12 counts when reading "19000" on range #20 at 40°C, the same meter will most likely have a drift of only +6 counts when reading "9000" on range #12 at 40°C.

The normally very accurate, temperature-insensitive autozero feature of the DMS-40LCD-4/20S's built-in analog-to-digital converter (A/D) is not a significant factor in determining the meter's overall zero-reading stability over its rated operating temperature because an offset voltage is applied to the A/D's LO input. This offset is used to null the signal voltage developed with a 4mA input. In order for the A/D to display a steady "0000" ±1 digit, the autozero circuitry requires both A/D inputs to always be at exactly zero volts.

The meter's zero-reading stability over its specified operating temperature is affected by the drift of three terms: the voltage developed by the meter's offset circuitry; the voltage developed across the meter's input resistors with a 4mA input; and the stability of the applied 4mA input signal itself. In the lower DIP-switch settings (ranges #1-4), the meter's parasitic etch and switch impedances also contribute a small error voltage.

The meter's performance with regards to span stability over temperature is affected by the drift of the meter's gain circuitry and loop input-resistors. To minimize these drifts in applications requiring the utmost in temperature stability, where possible, the meter should be calibrated at its anticipated operating temperature.

Since the DMS-40LCD-4/20S uses extremely-stable thin-film chip resistors, periodic re-calibration is typically required only in environmentally demanding applications where shock, vibration, and/or temperature extremes may have a detrimental effect on the 20-turn potentiometers.

DECIMAL POINT SETTINGS

Using the chart below as a guide, the DMS-40LCD-4/20S's decimal points can be configured to suit the user's particular readout requirements. To enable a desired decimal point place its DIP switch to the ON position (up). Please note that the decimal points are merely placeholders, that is, they can all be on or all off; they do not affect the meter's operation and/or display readings.

Switch S2			
SW3	SW4	SW5	SW6
DP1	DP2	DP3	DP4

OPERATING AND SETUP INSTRUCTIONS

The following procedure must be performed as the first re-calibration step every time DIP-switches S1 and S2 are reconfigured to select a new display range. The following procedure assumes the DMS-40LCD-4/20S is initially completely mis-adjusted, i.e., both potentiometers and DIP-switches S1 and S2 are randomly set. Make sure that all DIP-switch actuators are pushed as far as they will go to their designated ON (closed) or OFF (open) positions.

1. Set R7 (gain/span adjust) and R3 (zero/offset adjust) fully clockwise, roughly 20 turns, then using the settings found in the selected range, place the DIP-switches on S1 and S2 to the appropriate positions for the desired display reading.
2. Apply a precision 4mA input with proper polarity and adjust R3 (top 20-turn potentiometer) until the meter's display reads "0000."
3. Apply a precision 20mA input and adjust R7 (bottom 20-turn potentiometer) until the display reads the maximum desired reading. Repeat steps 2 and 3 to make sure the adjustments did not affect one another.
4. If necessary, select the appropriate decimal point by setting either SW3, SW4, SW5, or SW6 of S2 to ON (DP1, DP2, DP3, or DP4, respectively).

NOTE: Please keep in mind the transmitter's 4mA and 20mA output accuracy may affect display readings which are at, or very close to, the high and low limits of the selected range. See Example #2 below and Technical Note 1 for more information).

Examples

The examples below illustrate how to configure the meter to perform some typical measurements. Recall that R3 and R7 must be set to their full clockwise position before calibrating the meter.

1. Desired display readings are:

S1	S2
4mA = "0.000"	20mA = "3.000"
	

Use DIP-switch setting #3 in Table 1 and enable decimal point DP2 by placing SW4 of switch S2 to ON. Apply 4mA and adjust R3 so the display reads "0.000." Apply 20mA and adjust R7 so the display reads "3.000."

2. Desired display readings are:

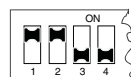
S1	S2
4mA = "0000"	20mA = "8600"
	

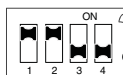

Use DIP-switch setting #11. Apply 4mA and adjust R3 so the display reads "0000." Apply 20mA and adjust R7 so the display reads "8600." If the transmitter's full-scale output is less than 20.0mA, it may not be possible to adjust R7 for a reading of "8600" with setting #11. If this occurs, select setting #12 and re-calibrate both R3 and R7 to obtain "0000" and "8600." Note that for these display readings no decimal points are used. Set SW3, SW4, SW5 and SW6 of switch S2 to OFF.

3. Desired display readings are:

S1	S2
4mA = "0000"	20mA = "10000"
	

Use DIP-switch setting #13. Apply 4mA and adjust R3 so the display reads "0000." Apply 20mA and adjust R7 so the display reads "10000." For these display readings no decimal points are used. Set SW3, SW4, SW5 and SW6 of switch S2 to OFF.

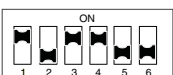
4. Desired display readings are:

S1	S2
4mA = ".0000"	12mA = ".2500"
	

This example is not as straightforward as the previous three. Notice that 12mA is exactly halfway between 4mA and 20mA. If we assume the input could go up to 20mA, the display reading would then be 2 x .2500 or ".5000." From Table 1, select DIP-switch setting #7 and enable DP1 via SW3 of switch S2. Apply 4mA and adjust R3 so the display reads ".0000." Apply 12mA and adjust R7 so the display reads ".2500."

Table 1. DIP-Switch Settings

Display Reading	Switch S1						Switch S2	
	SW1	SW2	SW3	SW4	SW5	SW6	SW1	SW2
4mA 20mA								
01. 0000 2250-2450	OFF	ON	ON	ON	OFF	OFF	ON	ON
02. 0000 2450-2800	OFF	ON	ON	ON	OFF	OFF	OFF	ON
03. 0000 2800-3200	OFF	ON	ON	ON	OFF	OFF	ON	OFF
04. 0000 3200-3850	OFF	ON	ON	ON	OFF	OFF	OFF	OFF
05. 0000 3850-4250	ON	OFF	ON	ON	OFF	OFF	ON	ON
06. 0000 4250-4800	ON	OFF	ON	ON	OFF	OFF	OFF	ON
07. 0000 4800-5500	ON	OFF	ON	ON	OFF	OFF	ON	OFF
08. 0000 5500-6200	ON	OFF	ON	ON	OFF	OFF	OFF	OFF
09. 0000 6200-6750	OFF	OFF	ON	ON	ON	OFF	ON	ON
10. 0000 6750-7700	OFF	OFF	ON	ON	ON	OFF	OFF	ON
11. 0000 7700-8600	ON	ON	OFF	ON	ON	OFF	ON	ON
12. 0000 8600-9800	ON	ON	OFF	ON	ON	OFF	OFF	ON
13. 0000 9800-10900	ON	ON	ON	OFF	OFF	ON	ON	ON
14. 0000 10900-12000	ON	ON	ON	OFF	OFF	ON	OFF	ON
15. 0000 12000-12800	ON	OFF	OFF	ON	OFF	ON	ON	ON
16. 0000 12800-14000	ON	OFF	OFF	ON	OFF	ON	OFF	ON
17. 0000 14000-15300	ON	OFF	ON	OFF	ON	ON	ON	ON
18. 0000 15300-16300	ON	OFF	ON	OFF	ON	ON	OFF	ON
19. 0000 16300-17600	OFF	OFF	ON	OFF	ON	ON	ON	ON
20. 0000 17600-19999	OFF	OFF	ON	OFF	ON	ON	OFF	ON

APPLICATIONS

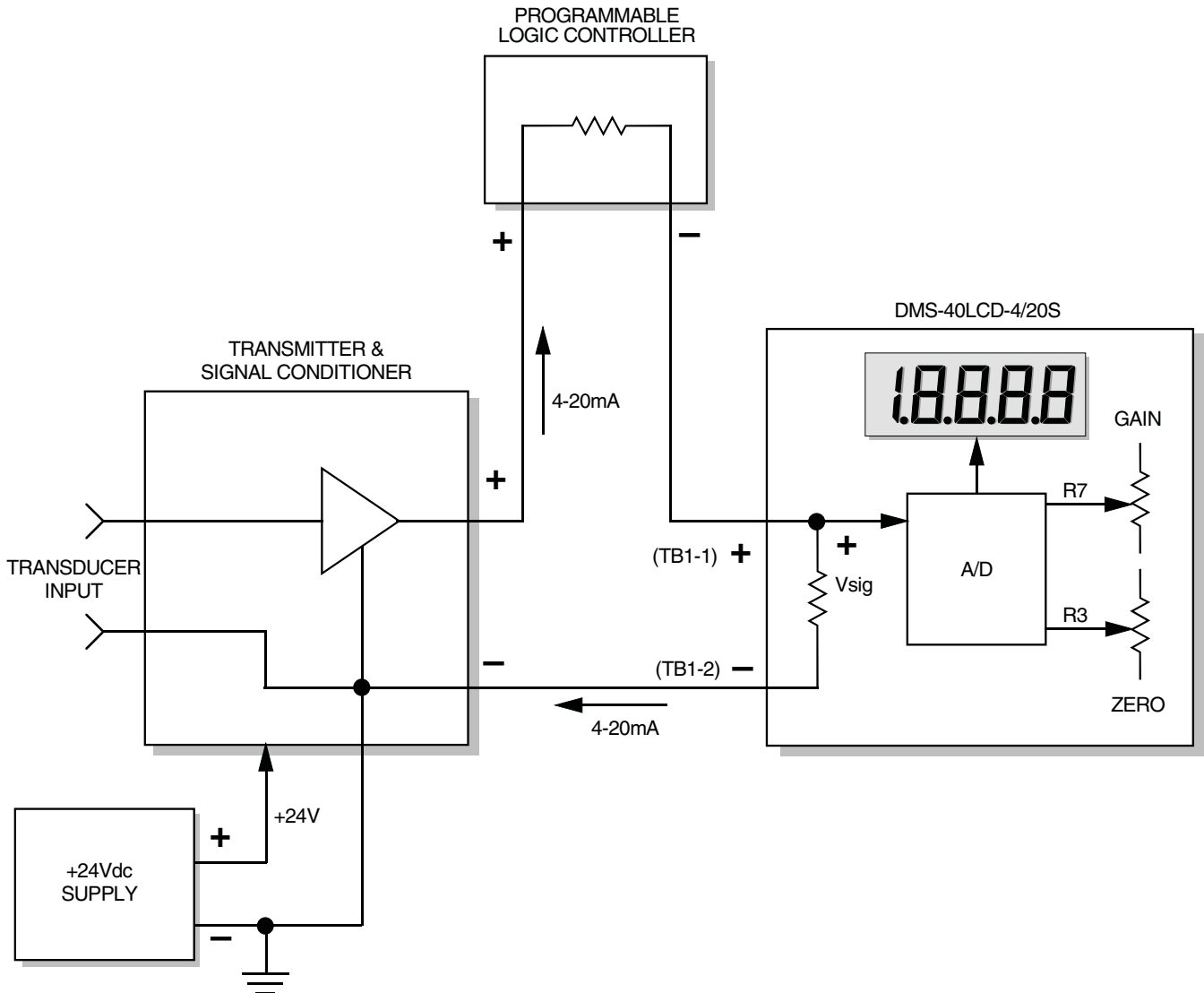

Figure 2. Typical DMS-40LCD-4/20S Connections

MECHANICAL SPECIFICATIONS

MECHANICAL DIMENSIONS: Inches (mm)

TOLERANCES: 2 PL DEC ±0.02 (±0.51)
3 PL DEC ±0.010 (±0.254)

WIRE SIZE: 18 to 26 AWG (Solid or stranded)

STRIPPING LENGTH: 0.20" (5.08mm)

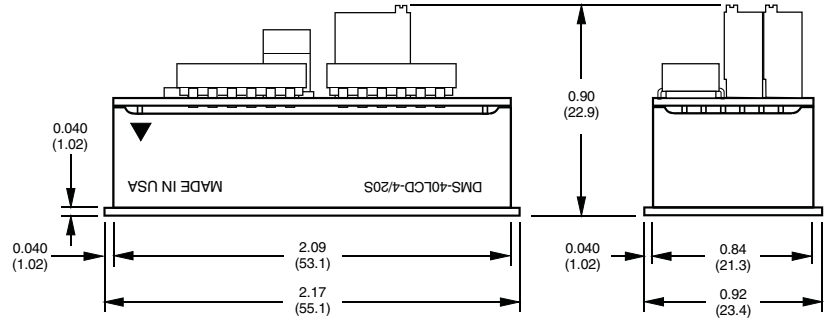

BACK VIEW

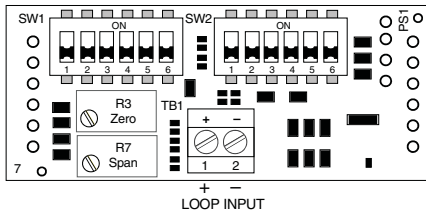

FRONT VIEW

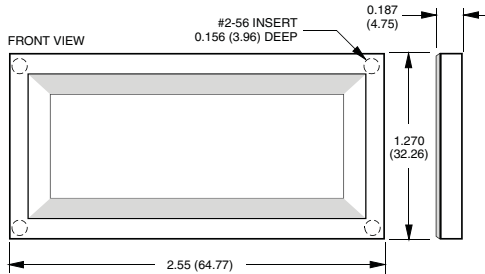
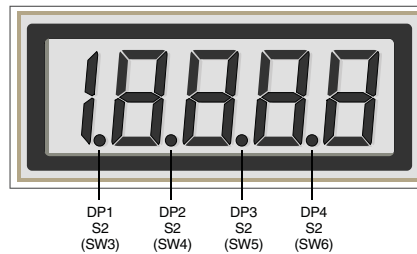

RECOMMENDED DRILL AND PANEL CUTOUT DIMENSIONS

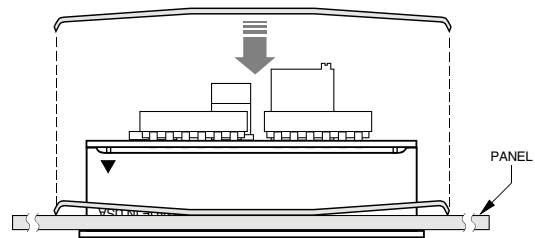
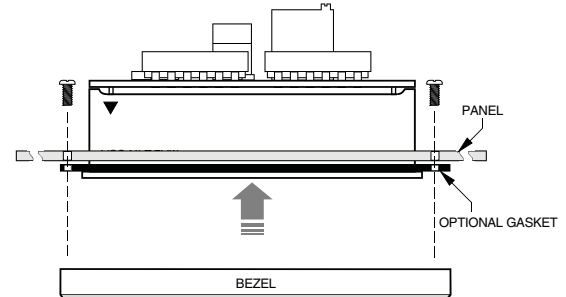
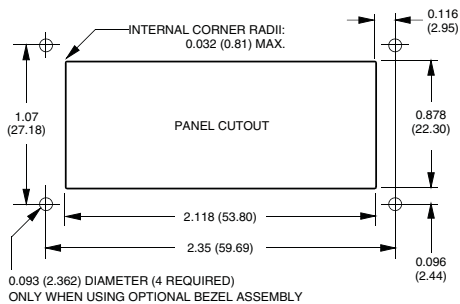

A panel-mount retaining clip is supplied with all models.

Murata Power Solutions, Inc.
11 Cabot Boulevard, Mansfield, MA 02048-1151 U.S.A.
ISO 9001 and 14001 REGISTERED



This product is subject to the following operating requirements and the Life and Safety Critical Application Sales Policy:
Refer to: <http://www.murata-ps.com/requirements/>

Murata Power Solutions, Inc. makes no representation that the use of its products in the circuits described herein, or the use of other technical information contained herein, will not infringe upon existing or future patent rights. The descriptions contained herein do not imply the granting of licenses to make, use, or sell equipment constructed in accordance therewith. Specifications are subject to change without notice. © 2015 Murata Power Solutions, Inc.

单击下面可查看定价，库存，交付和生命周期等信息

[>>Murata\(村田\)](#)