

Datasheet of SAW Device

SAW Duplexer

for Band8 / Unbalanced / LR /1814

Murata PN: SAYEY897MBG0F0A

■ Feature

- Band8 LTE
- Low Insertion Loss
- High Attenuation

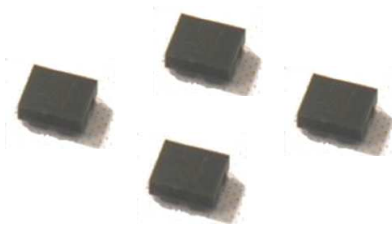

Note : Murata SAW Component is applicable for Cellular /Cordless phone (Terminal) relevant market only.
Please also read caution at the end of this document.

SAYEY897MBG0F0A (Band8 / Unbalanced / LR / 1814)

Revision Number	Date	Description
SAYEY897MBG0F0A_rev. A	Aug-20-2015	■ Initial Release
SAYEY897MBG0F0A_rev. B	Aug-21-2015	■ Updated for MP
SAYEY897MBG0F0A_rev. C	Aug-26-2016	■ Updated General Information
SAYEY897MBG0F0A_rev. D	Jun-22-2017	■ Updated General Information

- Operating temperature : -20 to +85 deg.C
- Storage temperature : -40 to +85 deg.C
- Input Power : +29 dBm 5000 h +55 deg.C
- D.C. Volatage between the terminals : 3V (25+/-2 deg.C)
- Minimum Resistance between the terminals : 10M ohm
- RoHS compliance : Yes
- ESD (ElectroStatic Discharge) sensitive device

SAYEY897MBG0F0A (Band8 / Unbalanced / LR / 1814)

Package Dimensions & Recommended Land Pattern

unit: mm

Dimensions

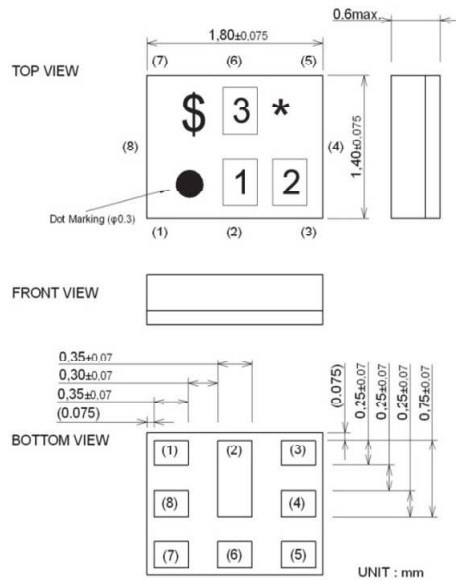

Marking : Laser Printing

* : Month code(Refer to the table A)

\$: Date code(Refer to the table B)

1 : 8

2 : G

3 : A

Terminal Number

(6) : Ant

(3) : TX

(1) : RX

Others : GND

Notice) Please refer to Measurement Circuit for Port information in detail.

Land Pattern

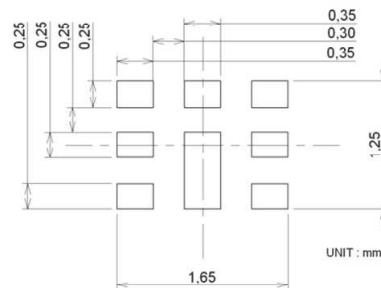

Measurement Circuit (Top Thru View)

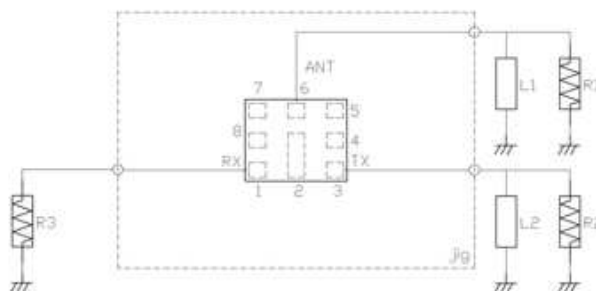

R1 : 50 ohm	L1 : 7.2nH(Ideal inductor)
	: 8.1nH(LQP03TN8N1)
	<Reference>
R2 : 50 ohm	L2 : 45nH(Ideal inductor)
R3 : 50 ohm	

SAYEY897MBG0F0A (Band8 / Unbalanced / LR / 1814)

Electrical Characteristic < TX→ANT. >

TX → ANT.		Characteristics (-20 to +85 deg.C)			Unit	Note
		min.	typ.*	max.		
Center Frequency			897.5		MHz	
Insertion Loss	882.5 to 912.5 MHz		1.7	2.5	dB _{INT}	Any 4.5MHz
Ripple Deviation	880. to 915. MHz		0.7	2.0	dB	Any 5MHz
VSWR	880. to 915. MHz		1.5	2.2		Ant
			1.5	2.2		Tx
Absolute Attenuation	10. to 716. MHz	30	35		dB	
	716. to 728. MHz	30	35		dB	
	728. to 793. MHz	30	35		dB	
	832. to 862. MHz	30	40		dB	B20 Tx
	927.5 to 957.5 MHz	35	54		dB _{INT}	Any 4.5MHz
	1559. to 1563. MHz	42	46		dB	Compass
	1565.42 to 1573.37 MHz	42	46		dB	Wideband GPS, lower side lobe
	1573.37 to 1577.47 MHz	42	46		dB	Regular GPS, main lobe
	1577.47 to 1585.42 MHz	42	46		dB	Wideband GPS, upper side lobe
	1597.55 to 1605.89 MHz	42	46		dB	GLONASS
	1710. to 1785. MHz	30	46		dB	B3Tx
	1760. to 1840. MHz	35	45		dB	2f
	1840. to 1880. MHz	35	44		dB	
	1920. to 1980. MHz	30	42		dB	B1 Tx
	2110. to 2170. MHz	30	40		dB	
	2400. to 2500. MHz	32	37		dB	2.4GHz ISM
	2434. to 2494. MHz	30	37		dB	
	2620. to 2745. MHz	30	37		dB	3f
	3520. to 3660. MHz	15	28		dB	4f
	4400. to 4575. MHz	3.0	8.9		dB	5f
	4900. to 5950. MHz	3.0	10.0		dB	5GHz ISM, 6f
	6160. to 6405. MHz	12	21		dB	7f
	7040. to 7320. MHz	12	20		dB	8f
	7920. to 8235. MHz	7.0	12.0		dB	9f
	8800. to 9150. MHz	5.0	11.0		dB	10f
	9680. to 10065. MHz	2.0	10.0		dB	11f
10560. to 10980. MHz	2.0	6.4		dB	12f	
11440. to 11895. MHz	2.0	4.1		dB	13f	
12320. to 12750. MHz	2.0	4.9		dB	14f	

* Typical value at 25±2deg.C

SAYEY897MBG0F0A (Band8 / Unbalanced / LR / 1814)

Electrical Characteristic < ANT.→RX >

ANT. → RX	Characteristics (-20 to +85 deg.C)			Unit	Note
	min.	typ.*	max.		
	Center Frequency		942.5		
Insertion Loss	927.5 to 957.5 MHz	2.0	2.5	dB _{INT}	Any 4.5MHz
Ripple Deviation	925. to 960. MHz	0.5	2.3	dB	Any 5MHz
VSWR	925. to 960. MHz	1.8	2.1		Ant
	925. to 960. MHz	1.7	2.1		Rx
Absolute Attenuation	0.2 to 880. MHz	45	54	dB	
	45. to 45. MHz	50	96	dB	Rx-Tx
	835. to 870. MHz	40	55	dB	2Tx-Rx
	882.5 to 912.5 MHz	45	56	dB _{INT}	Any 4.5MHz
	902.5 to 910. MHz	30	58	dB	(Rx+Tx)/2
	980. to 1045. MHz	12	17	dB	
	1045. to 6000. MHz	25	34	dB	
	1427. to 1448. MHz	40	59	dB	B11Tx
	1710. to 1785. MHz	40	66	dB	B3Tx
	1805. to 1920. MHz	40	66	dB	Rx+Tx and 2x
	1920. to 1980. MHz	40	65	dB	B1Tx
	1980. to 13025. MHz	8.0	15.0	dB	
	2400. to 2500. MHz	40	57	dB	2.4Ghz ISM
	2500. to 2570. MHz	40	57	dB	B7Tx
	2685. to 2790. MHz	40	56	dB	Rx+2Tx
	2775. to 2880. MHz	40	56	dB	3f
	2880. to 3700. MHz	35	50	dB	
	3700. to 3840. MHz	30	47	dB	4f
	4625. to 4800. MHz	28	36	dB	5f
	4900. to 5950. MHz	25	34	dB	5GHz ISM, 6f
	6475. to 6720. MHz	20	41	dB	7f
	7400. to 7680. MHz	20	32	dB	8f
	8325. to 8640. MHz	15	23	dB	9f
	9250. to 9600. MHz	8.0	16.0	dB	10f
10175. to 10560. MHz	8.0	16.0	dB	11f	
11100. to 11520. MHz	15	29	dB	12f	
12025. to 12480. MHz	15	23	dB	13f	

* Typical value at 25±2deg.C

SAYEY897MBG0F0A (Band8 / Unbalanced / LR / 1814)

Electrical Characteristic

< TX→ANT. >

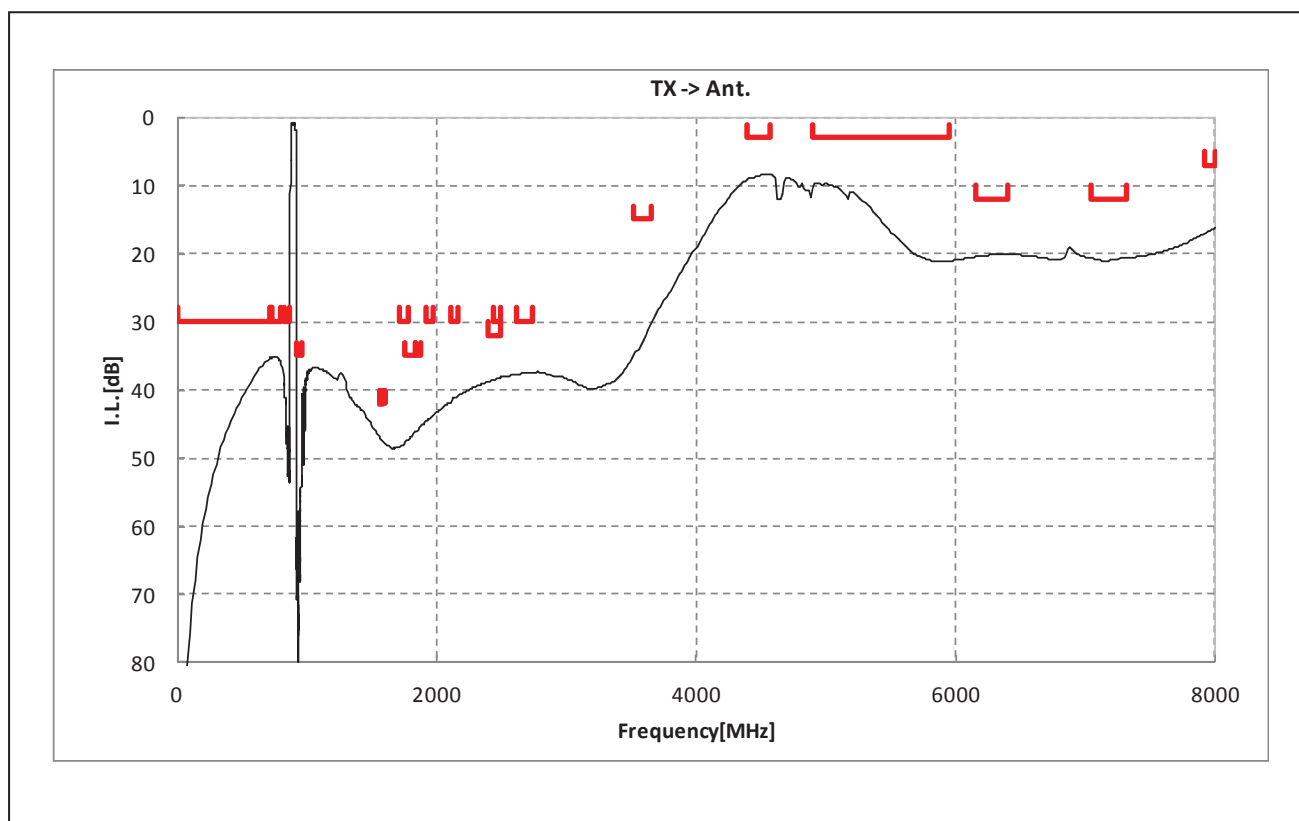
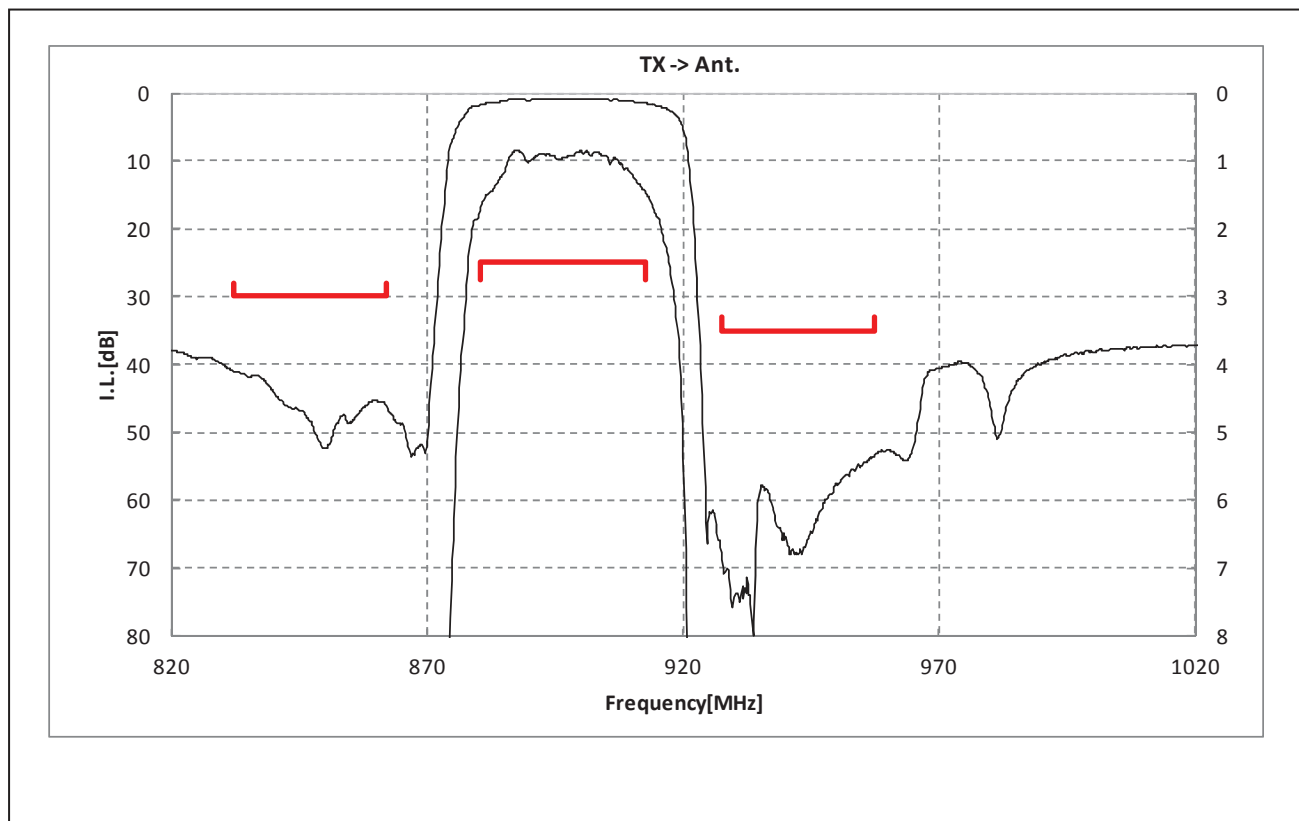

SAYEY897MBG0F0A (Band8 / Unbalanced / LR / 1814)

Electrical Characteristic

< ANT. → RX >

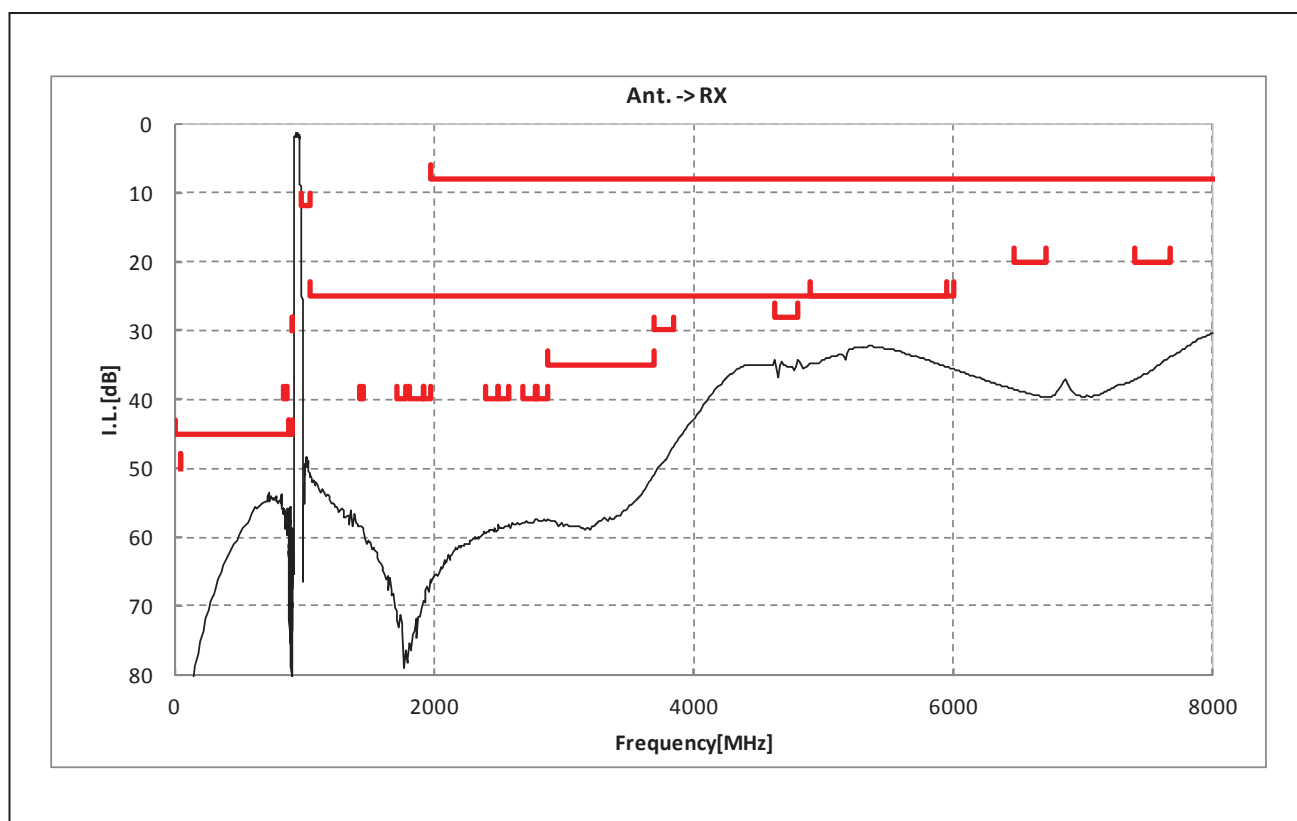
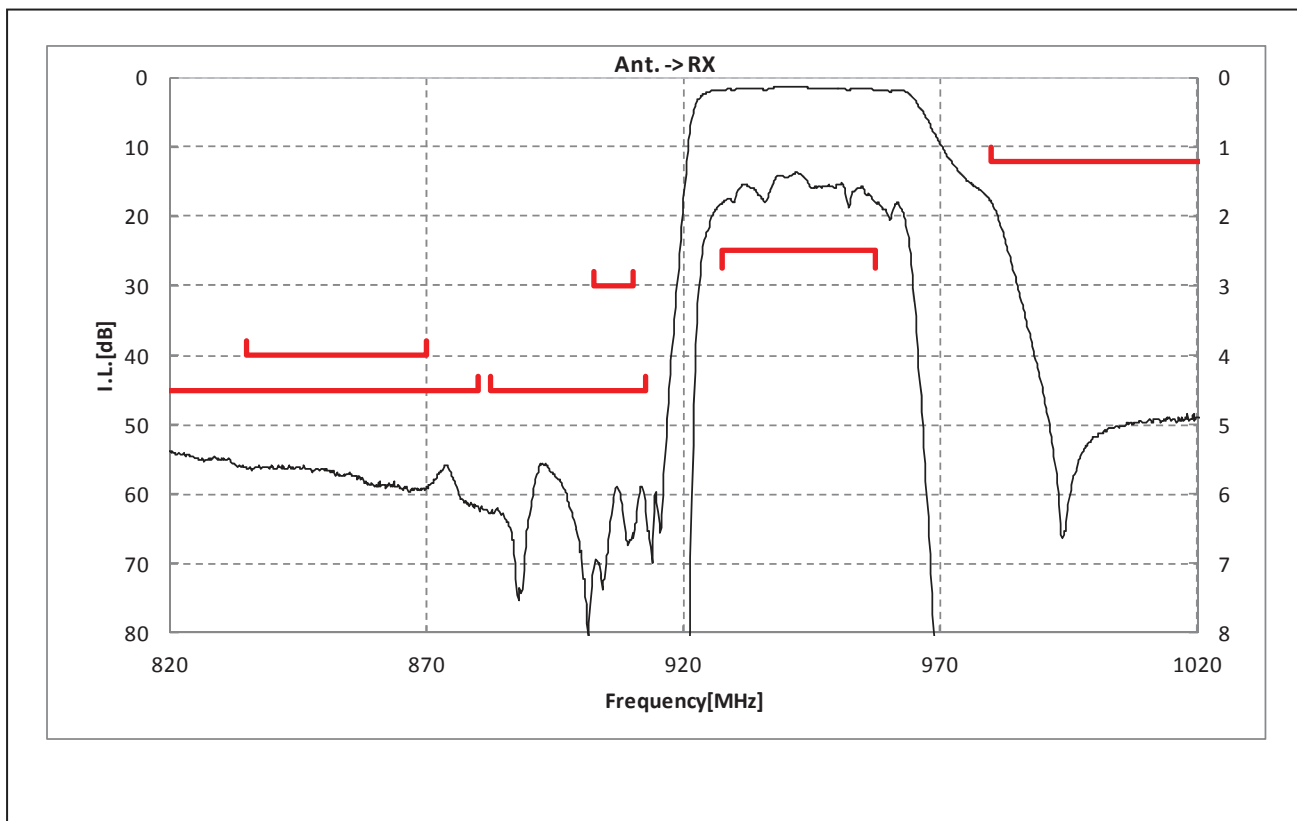

SAYEY897MBG0F0A (Band8 / Unbalanced / LR / 1814)

Electrical Characteristic

< TX→RX. >

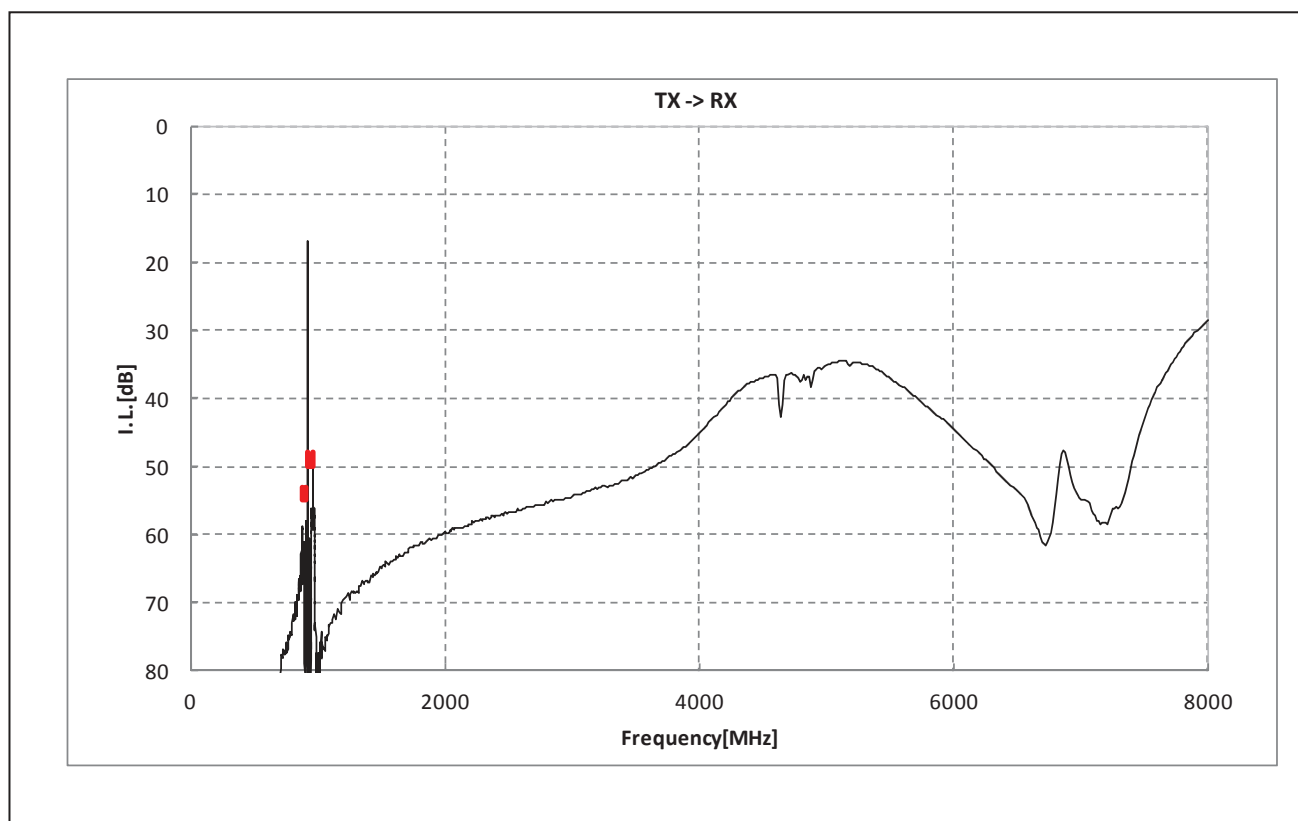
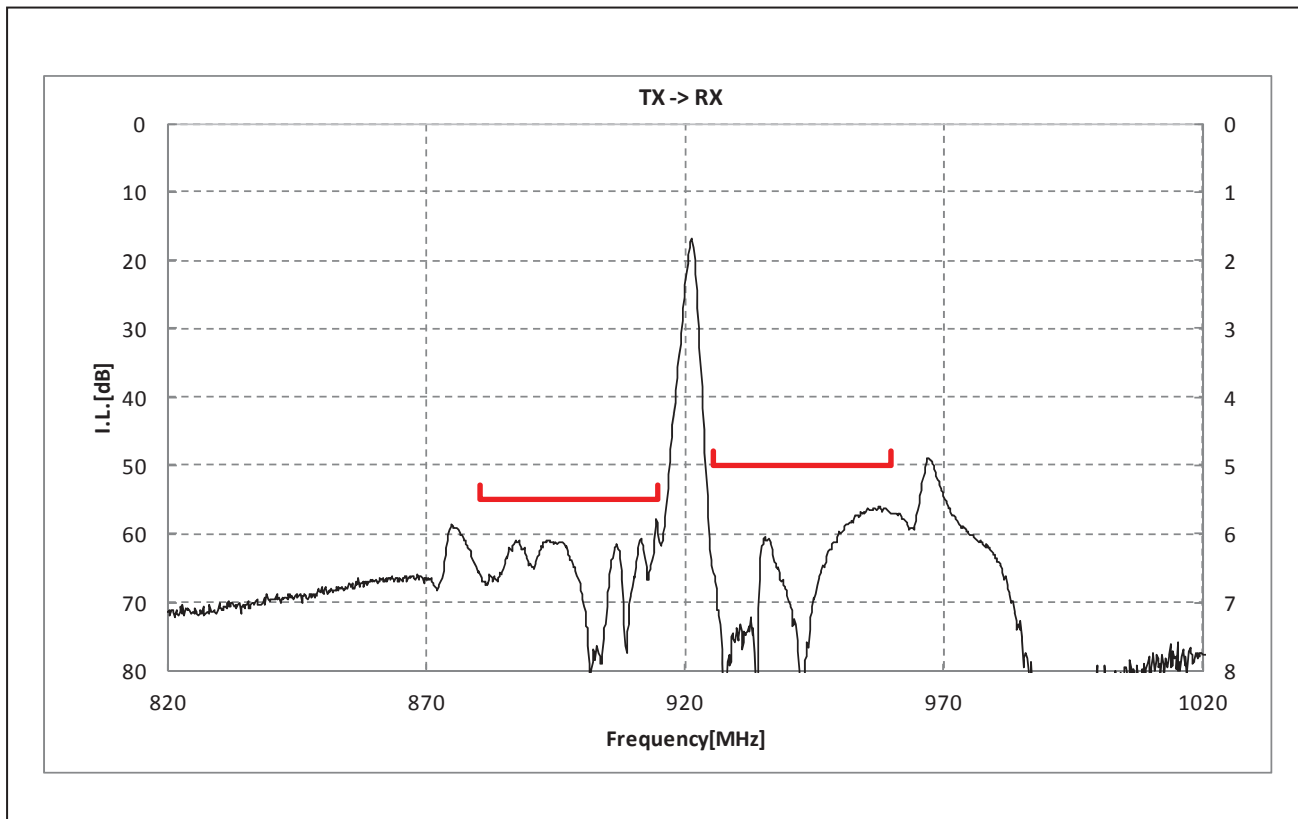

SAYEY897MBG0F0A (Band8 / Unbalanced / LR / 1814)

Dimensions of Tape & Reel unit: mm

Carrier Tape

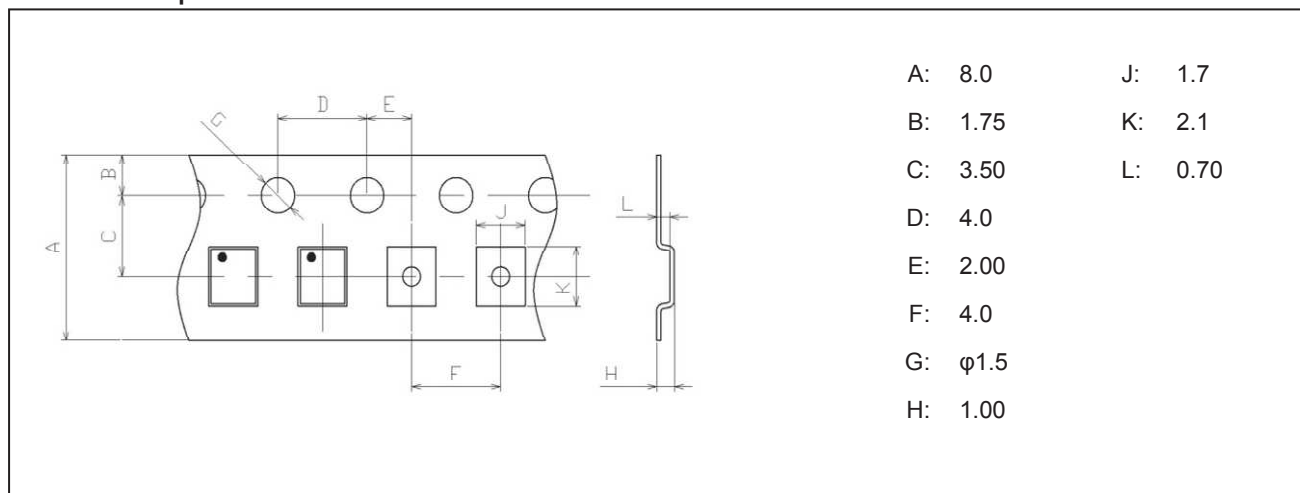

Tape

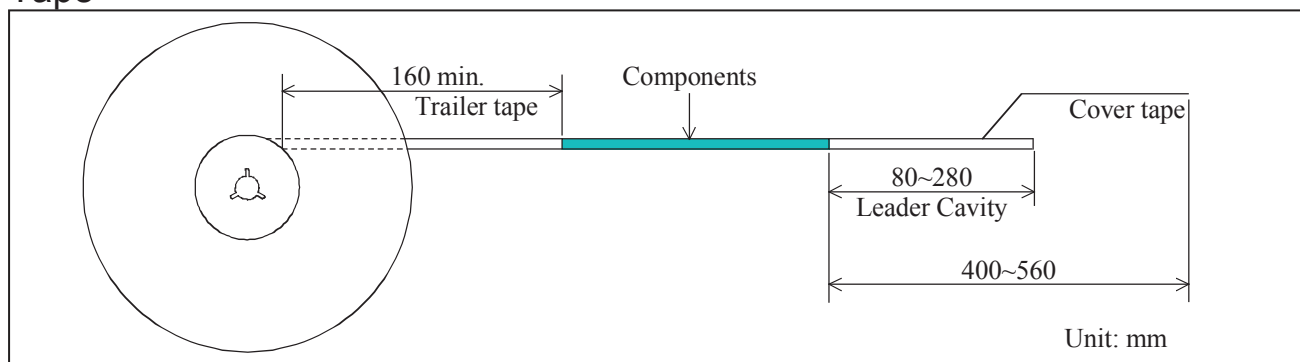

Reel

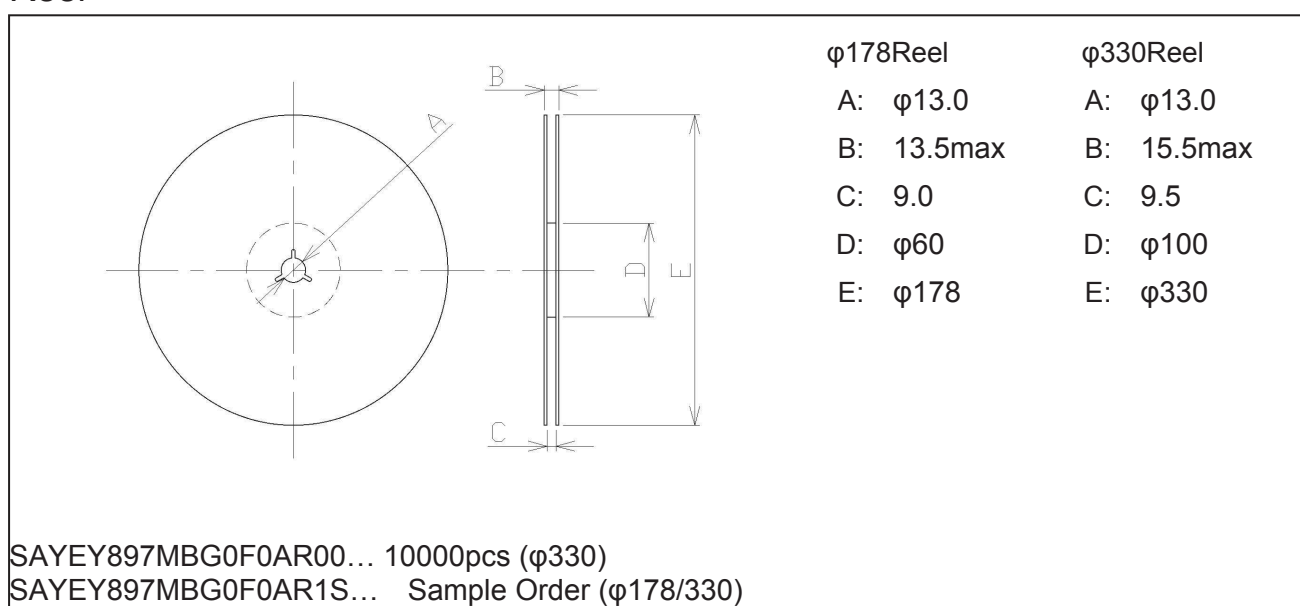

Marking Code

Table A: Month Code

2013 2017 2021	Jan.	Feb.	Mar.	Apr.	May.	Jun.	Jul.	Aug.	Sep.	Oct.	Nov.	Dec.
	A	B	C	D	E	F	G	H	J	K	L	M
2014 2018 2022	Jan.	Feb.	Mar.	Apr.	May.	Jun.	Jul.	Aug.	Sep.	Oct.	Nov.	Dec.
	N	P	Q	R	S	T	U	V	W	X	Y	Z
2015 2019 2023	Jan.	Feb.	Mar.	Apr.	May.	Jun.	Jul.	Aug.	Sep.	Oct.	Nov.	Dec.
	a	b	c̄	d	e	f	g	h	j	k	l	m
2016 2020 2024	Jan.	Feb.	Mar.	Apr.	May.	Jun.	Jul.	Aug.	Sep.	Oct.	Nov.	Dec.
	n	p	q	r	s	t	u	v	w	x	y	z

Table B: Date Code

date	1st	2nd	3rd	4th	5th	6th	7th	8th	9th	10th	
code	A	B	C	D	E	F	G	H	J	K	
date	11th	12th	13th	14th	15th	16th	17th	18th	19th	20th	
code	L	M	N	P	Q	R	S	T	U	V	
date	21st	22nd	23rd	24th	25th	26th	27th	28th	29th	30th	31st
code	W	X	Y	Z	a	b	c̄	d	e	f	g

Important Notice (1/2)

PLEASE READ THIS NOTICE BEFORE USING OUR PRODUCTS.

Please make sure that your product has been evaluated and confirmed from the aspect of the fitness for the specifications of our product when our product is mounted to your product. All the items and parameters in this product specification/datasheet/catalog have been prescribed on the premise that our product is used for the purpose, under the condition and in the environment specified in this specification. You are requested not to use our product deviating from the condition and the environment specified in this specification.

Please note that the only warranty that we provide regarding the products is its conformance to the specifications provided herein. Accordingly, we shall not be responsible for any defects in products or equipment incorporating such products, which are caused under the conditions other than those specified in this specification.

WE HEREBY DISCLAIMS ALL OTHER WARRANTIES REGARDING THE PRODUCTS, EXPRESS OR IMPLIED, INCLUDING WITHOUT LIMITATION ANY WARRANTY OF FITNESS FOR A PARTICULAR PURPOSE, THAT THEY ARE DEFECT-FREE, OR AGAINST INFRINGEMENT OF INTELLECTUAL PROPERTY RIGHTS.

The product shall not be used in any application listed below which requires especially high reliability for the prevention of such defect as may directly cause damage to the third party's life, body or property. You acknowledge and agree that, if you use our products in such applications, we will not be responsible for any failure to meet such requirements.

Furthermore, YOU AGREE TO INDEMNIFY AND DEFEND US AND OUR AFFILIATES AGAINST ALL CLAIMS, DAMAGES, COSTS, AND EXPENSES THAT MAY BE INCURRED, INCLUDING WITHOUT LIMITATION, ATTORNEY FEES AND COSTS, DUE TO THE USE OF OUR PRODUCTS IN SUCH APPLICATIONS.

Important Notice (2/2)

- Aircraft equipment.
- Aerospace equipment
- Undersea equipment.
- Power plant control equipment - Medical equipment.
- Transportation equipment (vehicles, trains, ships, elevator, etc.).
- Traffic signal equipment.
- Disaster prevention / crime prevention equipment.
- Burning / explosion control equipment
- Application of similar complexity and/ or reliability requirements to the applications listed in the above.

We expressly prohibit you from analyzing, breaking, Reverse-Engineering, remodeling altering, and reproducing our product. Our product cannot be used for the product which is prohibited from being manufactured, used, and sold by the regulations and laws in the world.

Please do not use the product in molding condition.

This product is ESD (ElectroStatic Discharge) sensitive device.

When you install or measure this, you should be careful not to add antistatic electricity or high voltage. Please be advised that you had better check anti surge voltage.

We do not warrant or represent that any license, either express or implied, is granted under any our patent right, copyright, mask work right, or our other intellectual property right relating to any combination, machine, or process in which our products or services are used. Information provided by us regarding third-party products or services does not constitute a license from us to use such products or services or a warranty or endorsement thereof. Use of such information may require a license from a third party under the patents or other intellectual property of the third party, or a license from us under our patents or other intellectual property.

Please do not use our products, our technical information and other data provided by us for the purpose of developing of mass-destruction weapons and the purpose of military use.

Moreover, you must comply with "foreign exchange and foreign trade law", the "U.S. export administration regulations", etc.

Please note that we may discontinue the manufacture of our products, due to reasons such as end of supply of materials and/or components from our suppliers.

Customer acknowledges that Murata will, if requested by you, conduct a failure analysis for defect or alleged defect of Products only at the level required for consumer grade Products, and thus such analysis may not always be available or be in accordance with your request (for example, in cases where the defect was caused by components in Products supplied to Murata from a third party).

The product shall not be used in any other application/model than that of claimed to Murata.

Customer acknowledges that engineering samples may deviate from specifications and may contain defects due to their development status.

We reject any liability or product warranty for engineering samples.

In particular we disclaim liability for damages caused by

- the use of the engineering sample other than for evaluation purposes, particularly the installation or integration in the product to be sold by you,
- deviation or lapse in function of engineering sample,
- improper use of engineering samples.

We disclaim any liability for consequential and incidental damages.

If you can't agree the above contents, you should inquire our sales.

单击下面可查看定价，库存，交付和生命周期等信息

[>>Murata\(村田\)](#)