

PLY10AS9012R0R2B

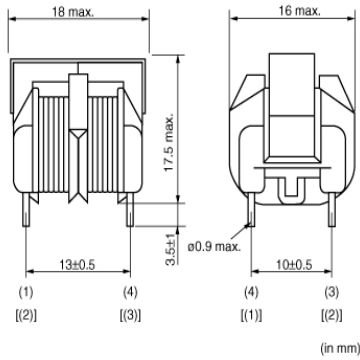

Appearance & Shape



Packaging Information

Packaging	Specifications	Standard Packing Quantity
-	Box	1200

Attention

1.This datasheet is downloaded from the website of Murata Manufacturing Co., Ltd. Therefore, it's specifications are subject to change or our products in it may be discontinued without advance notice. Please check with our sales representatives or product engineers before ordering.

2.This datasheet has only typical specifications because there is no space for detailed specifications.

Therefore, please review our product specifications or consult the approval sheet for product specifications before ordering.

PLY10AS9012R0R2B

Product Data

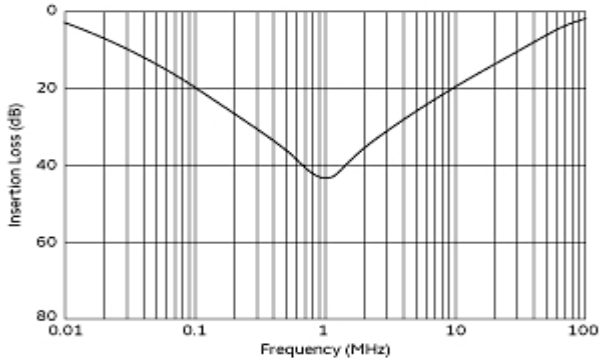

Common Mode Insertion Loss (Typ.)

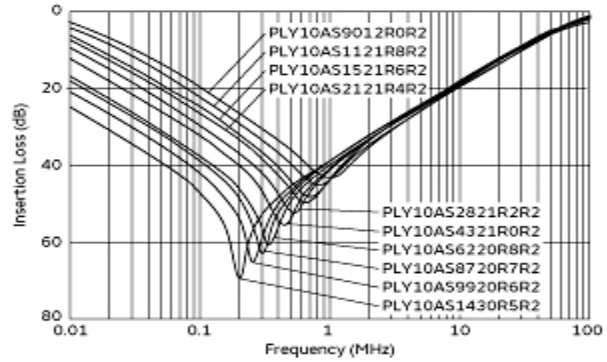

Common Mode Insertion Loss-Frequency Characteristics

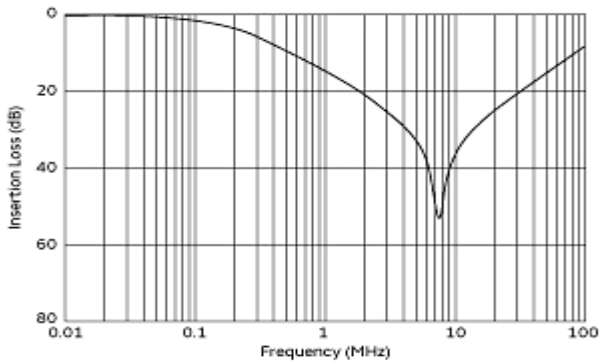

Differential Mode Insertion Loss (Typ.)

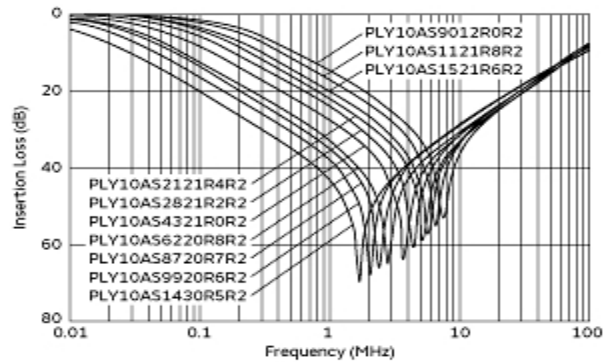

Differential Mode Insertion Loss-Frequency Characteristics

Attention

- 1.This datasheet is downloaded from the website of Murata Manufacturing Co., Ltd. Therefore, it's specifications are subject to change or our products in it may be discontinued without advance notice. Please check with our sales representatives or product engineers before ordering.
- 2.This datasheet has only typical specifications because there is no space for detailed specifications. Therefore, please review our product specifications or consult the approval sheet for product specifications before ordering.

单击下面可查看定价，库存，交付和生命周期等信息

[>>Murata\(村田\)](#)