

### FEATURES

- UL60950 recognised
- Operation to zero load
- Single isolated output
- 1kVDC isolation 'Hi Pot Test'
- Efficiency up to 87% typical
- Wide temperature performance at full 1 watt load, -40°C to 85°C
- Industry standard pinout
- 3.3V, 5V, 12V, 15V & 24V inputs
- 3.3V, 5V, 9V, 12V & 15V outputs
- Custom solutions available
- Pin compatible with CME, CRE1, CRL2, LME, NME, NKE & NML series
- PCB mounting

### DESCRIPTION

The MEE1 series is the new high performance version of our 1W NME series. The MEE1 series is more efficient and offers improved regulation performance for applications where a wide output voltage variation can not be tolerated. They are ideally suited for providing local supplies on control system boards with the added benefit of 1kVDC galvanic isolation to reduce switching noise.

### SELECTION GUIDE

Order Code	Nominal Input Voltage	Output Voltage	Output Current	Load Regulation (Typ)	Load Regulation (Max)	Ripple & Noise (Typ)	Ripple & Noise (Max)	Input Current at Rated Load	Efficiency (Min)	Efficiency (Typ)	Isolation Capacitance (Typ)	MTTF <sup>1</sup>	Package Style	Recommended Alternative
	V	V	mA	%	%	mVp-p	mVp-p	mA	%	%	pF	kHrs		
	<span style="border: 1px solid green; border-radius: 5px; padding: 2px;">Recommended</span> <span style="border: 1px solid blue; border-radius: 5px; padding: 2px; margin-left: 10px;">In Production</span>													
MEE1S0303SC	3.3	3.3	303	10	12	26	50	377	76	78.5	42	3852	SIP	
MEE1S0305SC	3.3	5	200	9.2	11	23	50	360	79	81.5	44	4008		
MEE1S0312SC	3.3	12	83	8.7	11	14	40	352	81	84	48	4040		
MEE1S0315SC	3.3	15	67	7.8	10	12	35	350	82	84.5	50	3792		
MEE1S0503SC	5	3.3	303	8	10	22	45	246	76	80	39	3213		
MEE1S0505SC	5	5	200	5.6	7	19	40	237	80	83	46	3990		
MEE1S0509SC	5	9	111	6.8	9	13	35	238	80	83.5	53	4526		
MEE1S0512SC	5	12	83	6.5	8	11	35	233	81	85	49	3756		
MEE1S0515SC	5	15	67	5.7	8	9	30	230	83	85.5	46	3240		
MEE1S1205SC	12	5	200	5	7	16	40	97	79	83.5	47	3857		
MEE1S1209SC	12	9	111	5.8	8	12	35	97	79	84	77	4370		
MEE1S1212SC	12	12	83	4.8	6	10	35	97	82	85	79	3774		
MEE1S1215SC	12	15	67	4.2	7	9	35	95	81	86.5	81	3779		
MEE1S1505SC	15	5	200	4.2	6	15	40	79	77	83.5	41	3312		
MEE1S1509SC	15	9	111	5.1	7	12	35	79	77	83	65	3451		
MEE1S1512SC	15	12	83	4.3	5	11	35	77	78	85	77	3940		
MEE1S1515SC	15	15	67	3.8	5	8	30	76	83	86.5	100	3420		
MEE1S2405SC	24	5	200	3.6	5	19	50	49	75	83	51	3983		
MEE1S2409SC	24	9	111	4	6	17	40	50	74	83	70	4255		
MEE1S2412SC	24	12	83	3.4	5	11	35	49	79	85.5	89	3991		
MEE1S2415SC	24	15	67	3	5	9	35	49	78	86	101	3532		
MEE1S0303DC	3.3	3.3	303	10	12	26	50	377	76	78.5	42	3852	DIP	
MEE1S0312DC	3.3	12	83	8.7	11	14	40	352	81	84	48	4040		
MEE1S0503DC	5	3.3	303	8	10	22	45	246	76	80	39	3213		
MEE1S0505DC	5	5	200	5.6	7	19	40	237	80	83	46	3990		
MEE1S0509DC	5	9	111	6.8	9	13	35	238	80	83.5	53	4526		
MEE1S0512DC	5	12	83	6.5	8	11	35	233	81	85	49	3756		
MEE1S1205DC	12	5	200	5	7	16	40	97	79	83.5	47	3857		
MEE1S1209DC	12	9	111	5.8	8	12	35	97	79	84	77	4370		
MEE1S1212DC	12	12	83	4.8	6	10	35	97	82	85	79	3774		
MEE1S1215DC	12	15	67	4.2	7	9	35	95	81	86.5	81	3779		
MEE1S1505DC	15	5	200	4.2	6	15	40	79	77	83.5	41	3312		
MEE1S1509DC	15	9	111	5.1	7	12	35	79	77	83	65	3451		
MEE1S2405DC	24	5	200	3.6	5	19	50	49	75	83	51	3983		
MEE1S2409DC	24	9	111	4	6	17	40	50	74	83	70	4255		



For full details go to [www.murata-ps.com/rohs](http://www.murata-ps.com/rohs)



1. Calculated using MIL-HDBK-217F FN2 with nominal input voltage at full load.

All specifications typical at T<sub>A</sub>=25°C, nominal input voltage and rated output current unless otherwise specified.

**SELECTION GUIDE (Continued)**

Order Code	Nominal Input Voltage	Output Voltage	Output Current	Load Regulation (Typ)	Load Regulation (Max)	Ripple & Noise (Typ)	Ripple & Noise (Max)	Input Current at Rated Load	Efficiency (Min)	Efficiency (Typ)	Isolation Capacitance (Typ)	MTTF <sup>1</sup>	Package Style	Recommended Alternative
	V	V	mA	%	%	mVp-p	mVp-p	mA	%	%	pF	kHrs		
	<b>To be discontinued</b>													
<b>MEE1S0309SC</b>	3.3	9	111	10	12	15	40	361	79	81.5	47	4930	SIP	NKE0309SC
<b>MEE1S0305DC</b>	3.3	5	200	9.2	11	23	50	360	79	81.5	44	4008	DIP	NKE0305DC
<b>MEE1S0309DC</b>	3.3	9	111	10	12	15	40	361	79	81.5	47	4930		NKE0309DC
<b>MEE1S0315DC</b>	3.3	15	67	7.8	10	12	35	350	82	84.5	50	3792		MEE1S0315SC
<b>MEE1S0515DC</b>	5	15	67	5.7	8	9	30	230	83	85.5	46	3240		NME0515DC
<b>MEE1S1512DC</b>	15	12	83	4.3	5	11	35	77	78	85	77	3940		MEE1S1512SC
<b>MEE1S1515DC</b>	15	15	67	3.8	5	8	30	76	83	86.5	100	3420		NME1515SC
<b>MEE1S2412DC</b>	24	12	83	3.4	5	11	35	49	79	85.5	89	3991		NME2412DC
<b>MEE1S2415DC</b>	24	15	67	3	5	9	35	49	78	86	101	3532		NME2415DC

**INPUT CHARACTERISTICS**

Parameter	Conditions	Min.	Typ.	Max.	Units
Voltage range	Continuous operation, 3.3V input types	2.97	3.3	3.63	V
	Continuous operation, 5V input types	4.5	5.0	5.5	
	Continuous operation, 12V input types	10.8	12.0	13.2	
	Continuous operation, 15V input types	13.5	15	16.5	
	Continuous operation, 24V input types	21.6	24	26.4	
Reflected ripple current	3.3V, 5V & 12V Input types		5	20	mA p-p
	15V Input types		3	10	
	24V Input types		4	10	

**OUTPUT CHARACTERISTICS**

Parameter	Conditions	Min.	Typ.	Max.	Units
Rated Power	T <sub>A</sub> =-40°C to 85°C			1.0	W
Voltage Set Point Accuracy	See tolerance envelope				
Line regulation	High V <sub>IN</sub> to low V <sub>IN</sub>	3.3V Input	1.0	1.15	%/%
		All other inputs	1.0	1.1	

**ISOLATION CHARACTERISTICS**

Parameter	Conditions	Min.	Typ.	Max.	Units
Isolation test voltage	Flash tested for 1 second	1000			VDC
Resistance	Viso= 1000VDC	10			GΩ

**GENERAL CHARACTERISTICS**

Parameter	Conditions	Min.	Typ.	Max.	Units
Switching frequency	3.3V input types		47		kHz
	5V input types		60		
	12V input types		70		
	15V input types		77		
	24V input types		80		

1. Calculated using MIL-HDBK-217F FN2 with nominal input voltage at full load.

All specifications typical at T<sub>A</sub>=25°C, nominal input voltage and rated output current unless otherwise specified

TEMPERATURE CHARACTERISTICS					
Parameter	Conditions	Min.	Typ.	Max.	Units
Specification	All output types	-40		85	°C
Storage		-50		125	
Case Temperature above ambient	MEE1S0303XC			30	
	All other types			25	
Cooling	Free air convection				

ABSOLUTE MAXIMUM RATINGS	
Lead temperature 1.5mm from case for 10 seconds	260°C
Internal power dissipation	450mW
Wave Solder	Wave Solder profile not to exceed the profile recommended in IEC 61760-1 Section 6.1.3. Please refer to <a href="#">application notes</a> for further information.
Input voltage $V_{IN}$ , MEE1S03 types	5.5V
Input voltage $V_{IN}$ , MEE1S05 types	7V
Input voltage $V_{IN}$ , MEE1S12 types	15V
Input voltage $V_{IN}$ , MEE1S15 types	18V
Input voltage $V_{IN}$ , MEE1S24 types	28V

**TECHNICAL NOTES**

**ISOLATION VOLTAGE**

'Hi Pot Test', 'Flash Tested', 'Withstand Voltage', 'Proof Voltage', 'Dielectric Withstand Voltage' & 'Isolation Test Voltage' are all terms that relate to the same thing, a test voltage, applied for a specified time, across a component designed to provide electrical isolation, to verify the integrity of that isolation.

Murata Power Solutions MEE1 series of DC-DC converters are all 100% production tested at their stated isolation voltage. This is 1kVDC for 1 second.

A question commonly asked is, "What is the continuous voltage that can be applied across the part in normal operation?"

The MEE1 has been recognised by Underwriters Laboratory for functional insulation, both input and output should normally be maintained within SELV limits i.e. less than 42.4V peak, or 60VDC. The isolation test voltage represents a measure of immunity to transient voltages and the part should never be used as an element of a safety isolation system. The part could be expected to function correctly with several hundred volts offset applied continuously across the isolation barrier; but then the circuitry on both sides of the barrier must be regarded as operating at an unsafe voltage and further isolation/insulation systems must form a barrier between these circuits and any user-accessible circuitry according to safety standard requirements.

**REPEATED HIGH-VOLTAGE ISOLATION TESTING**

It is well known that repeated high-voltage isolation testing of a barrier component can actually degrade isolation capability, to a lesser or greater degree depending on materials, construction and environment. The MEE1 series has toroidal isolation transformers, with no additional insulation between primary and secondary windings of enamelled wire. While parts can be expected to withstand several times the stated test voltage, the isolation capability does depend on the wire insulation. Any material, including this enamel (typically polyurethane) is susceptible to eventual chemical degradation when subject to very high applied voltages thus implying that the number of tests should be strictly limited. We therefore strongly advise against repeated high voltage isolation testing, but if it is absolutely required, that the voltage be reduced by 20% from specified test voltage. This consideration equally applies to agency recognised parts rated for better than functional isolation where the wire enamel insulation is always supplemented by a further insulation system of physical spacing or barriers.

**SAFETY APPROVAL**

The MEE1 series has been recognised by Underwriters Laboratory (UL) to UL 60950 for functional insulation in a maximum ambient temperature for 3.3V and 5V input models of 60°C and for 12V, 15V and 24V models of 85°C. File number E151252 applies. The MEE1 Series of converters are not internally fused so to meet the requirements of UL 60950 an anti-surge input line fuse should always be used with ratings as defined below.

- MEE1S03xxxC: 1A
- MEE1S05xxxC: 0.7A
- MEE1S12xxxC: 0.2A
- MEE1S15xxxC: 0.2A
- MEE1S24xxxC: 0.16A

All fuses should be UL approved and rated to at least the maximum allowable DC input voltage. UL file number E151252 applies.

**RoHS COMPLIANCE INFORMATION**



This series is compatible with RoHS soldering systems with a peak wave solder temperature of 260°C for 10 seconds. Please refer to [application notes](#) for further information. The pin termination finish on the SIP package type is Tin Plate, Hot Dipped over Matte Tin with Nickel Preplate. The DIP types are Matte Tin over Nickel Preplate. Both types in this series are backward compatible with Sn/Pb soldering systems. For further information, please visit [www.murata-ps.com/rohs](http://www.murata-ps.com/rohs)

**PART NUMBER STRUCTURE**

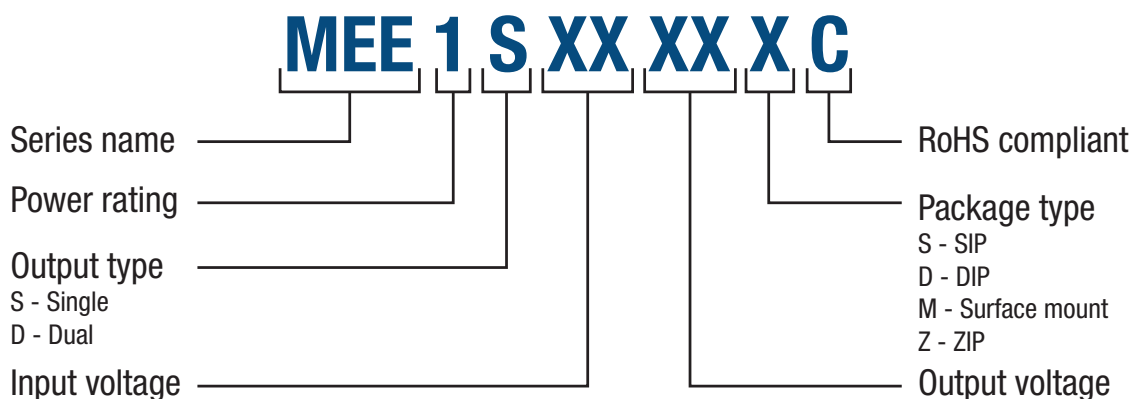

**CHARACTERISATION TEST METHODS**

**Ripple & Noise Characterisation Method**

Ripple and noise measurements are performed with the following test configuration.

C1	1µF X7R multilayer ceramic capacitor, voltage rating to be a minimum of 3 times the output voltage of the DC-DC converter
C2	10µF tantalum capacitor, voltage rating to be a minimum of 1.5 times the output voltage of the DC-DC converter with an ESR of less than 100mΩ at 100 kHz
C3	100nF multilayer ceramic capacitor, general purpose
R1	450Ω resistor, carbon film, ±1% tolerance
R2	50Ω BNC termination
T1	3T of the coax cable through a ferrite toroid
RLOAD	Resistive load to the maximum power rating of the DC-DC converter. Connections should be made via twisted wires

Measured values are multiplied by 10 to obtain the specified values.

**Differential Mode Noise Test Schematic**

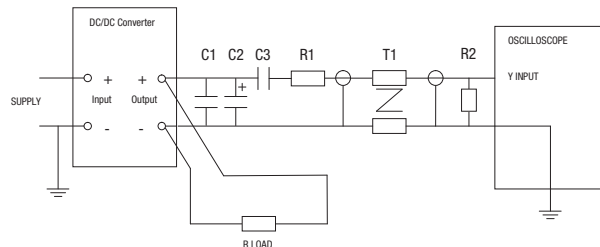

**APPLICATION NOTES**

**Minimum Load**

The minimum load to meet datasheet specification is 10% of the full rated load across the specified input voltage range. Lower than 10% minimum loading will result in an increase in output voltage, which may rise to typically 1.5 times the specified output voltage if the output load falls to less than 5%.

**Capacitive loading and start up**

Typical start up times for this series, with a typical input voltage rise time of 2.2µs and output capacitance of 10µF, are shown in the table below. The product series will start into a capacitance of 47µF with an increased start time, however, the maximum recommended output capacitance is 10µF.

	Start-up time		Start-up time
	µs		µs
MEE1S0303XC	355	MEE1S1209XC	818
MEE1S0305XC	622	MEE1S1212XC	1285
MEE1S0309XC	1542	MEE1S1215XC	2052
MEE1S0312XC	2410	MEE1S1505XC	260
MEE1S0315XC	3346	MEE1S1509XC	642
MEE1S0503XC	334	MEE1S1512XC	993
MEE1S0505XC	402	MEE1S1515XC	1574
MEE1S0509XC	1316	MEE1S2405XC	221
MEE1S0512XC	1776	MEE1S2409XC	541
MEE1S0515XC	2232	MEE1S2412XC	860
MEE1S1205XC	285	MEE1S2415XC	1049

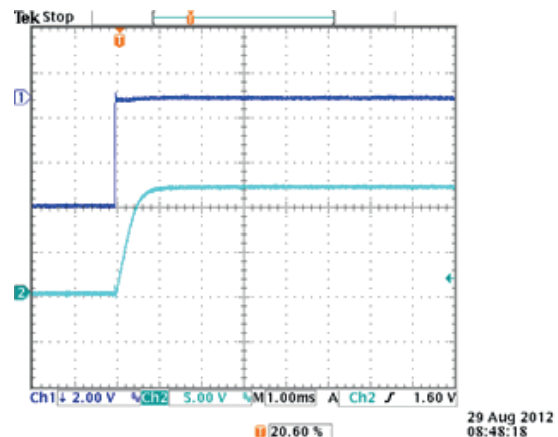

**APPLICATION NOTES (Continued)**

**Output Ripple Reduction**

By using the values of inductance and capacitance stated, the output ripple at the rated load is lowered to 5mV p-p max.

**Component selection**

**Capacitor:** It is required that the ESR (Equivalent Series Resistance) should be as low as possible, ceramic types are recommended. The voltage rating should be at least twice (except for 15V output), the rated output voltage of the DC-DC converter.

**Inductor:** The rated current of the inductor should not be less than that of the output of the DC-DC converter. At the rated current, the DC resistance of the inductor should be such that the voltage drop across the inductor is <2% of the rated voltage of the DC-DC converter. The SRF (Self Resonant Frequency) should be >20MHz.

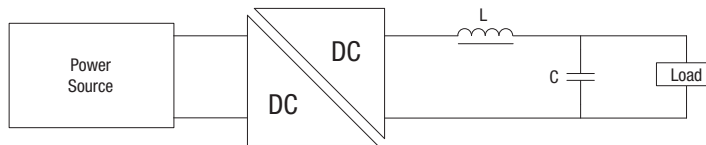

	Inductor			Capacitor
	L, $\mu$ H	SMD	Through Hole	C, $\mu$ F
MEE1S0303XC	4.7	82472C	11R472C	10
MEE1S0305XC	10	82103C	11R103C	4.7
MEE1S0309XC	22	82223C	11R223C	2.2
MEE1S0312XC	47	82473C	11R473C	1
MEE1S0315XC	47	82473C	11R473C	1
MEE1S0503XC	4.7	82472C	11R472C	10
MEE1S0505XC	10	82103C	11R103C	4.7
MEE1S0509XC	22	82223C	11R223C	2.2
MEE1S0512XC	47	82473C	11R473C	1
MEE1S0515XC	47	82473C	11R473C	1
MEE1S1205XC	10	82103C	11R103C	4.7
MEE1S1209XC	22	82223C	11R223C	2.2
MEE1S1212XC	47	82473C	11R473C	1
MEE1S1215XC	47	82473C	11R473C	1
MEE1S1505XC	10	82103C	11R103C	4.7
MEE1S1509XC	22	82223C	11R223C	2.2
MEE1S1512XC	47	82473C	11R473C	1
MEE1S1515XC	47	82473C	11R473C	1
MEE1S2405XC	10	82103C	11R103C	4.7
MEE1S2409XC	22	82223C	11R223C	2.2
MEE1S2412XC	47	82473C	11R473C	1
MEE1S2415XC	47	82473C	11R473C	1

**TEMPERATURE DERATING**

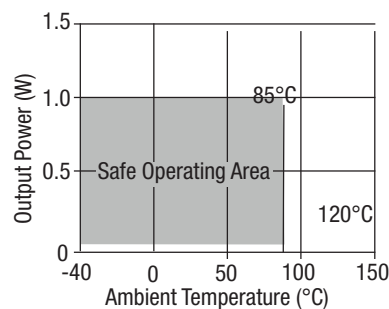

**TOLERANCE ENVELOPES**

The voltage tolerance envelopes show typical load regulation characteristics for this product series. The tolerance envelope is the maximum output voltage variation due to changes in output loading and set point accuracy.

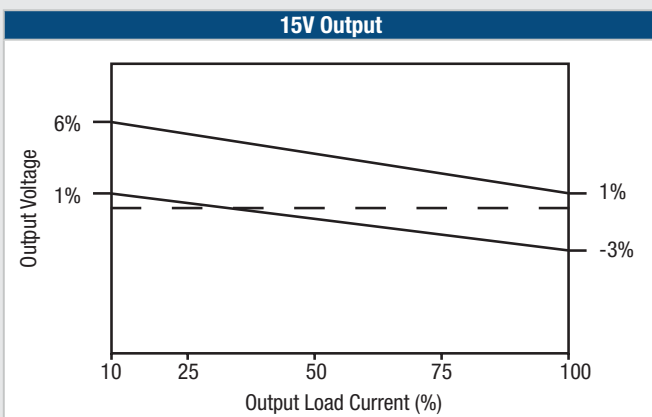
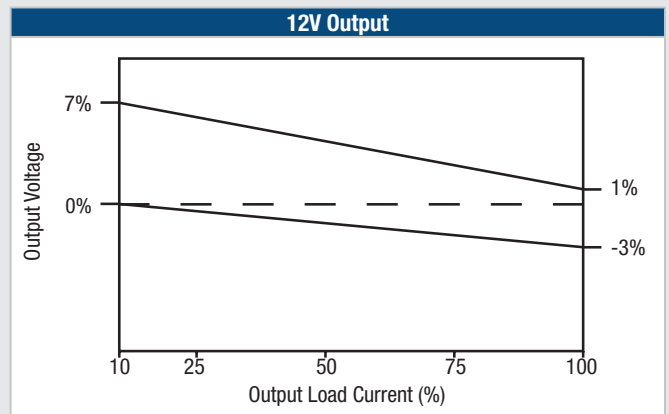
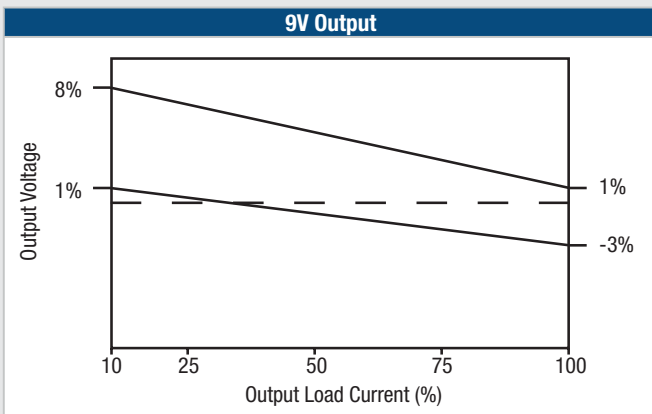
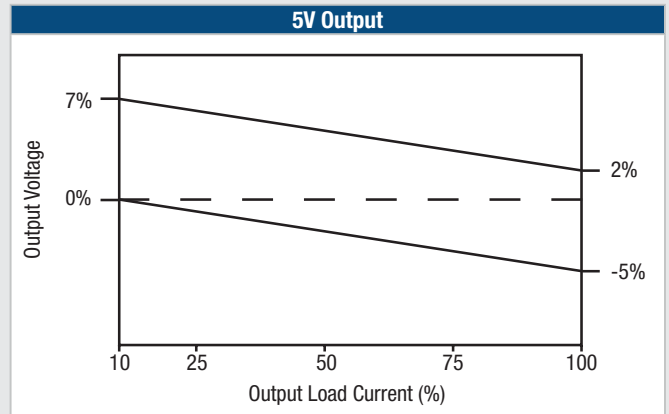
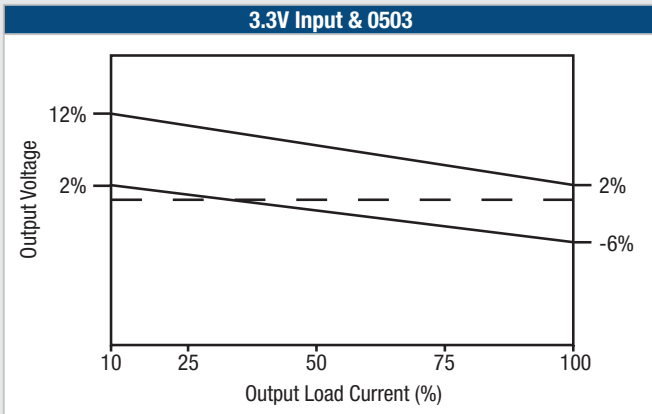

**EFFICIENCY VS LOAD**

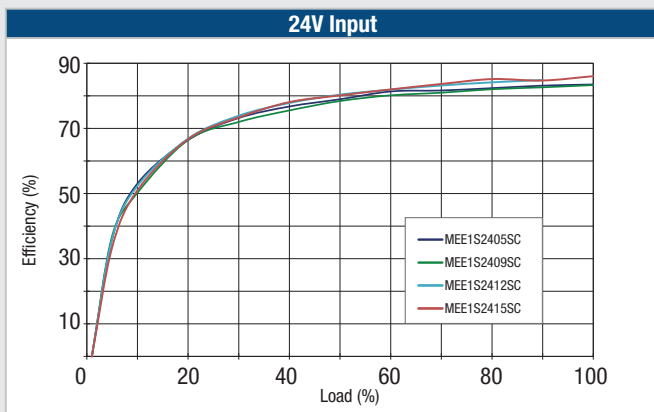
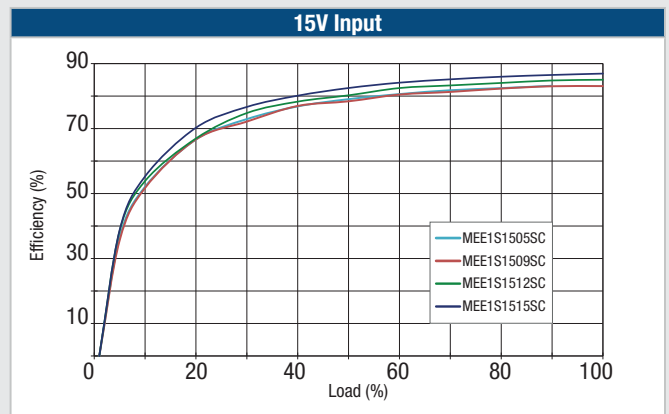
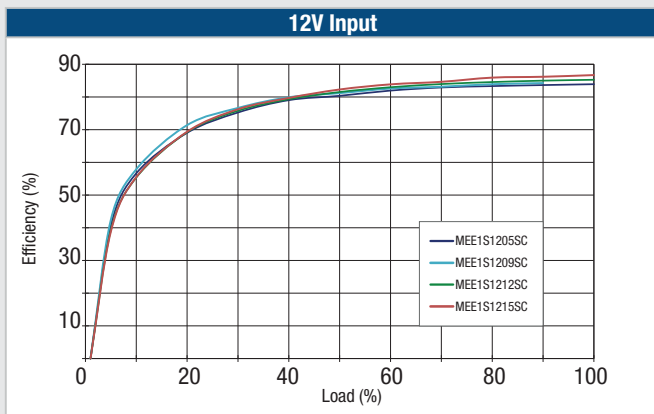
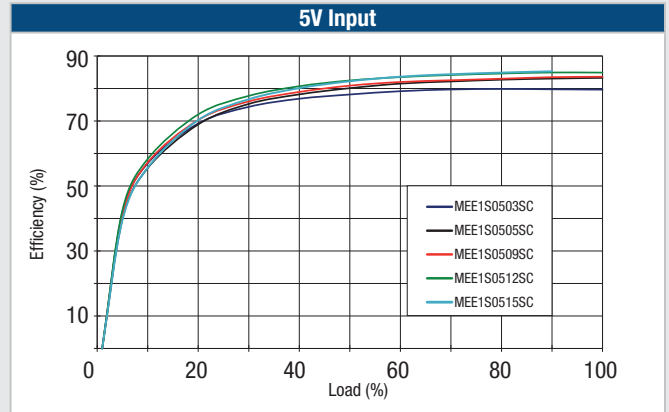
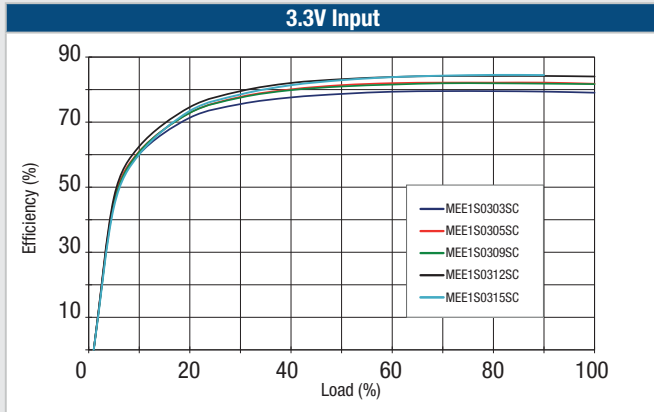



**EMC FILTERING AND SPECTRA**

**FILTERING**

An input capacitor and inductor is required to meet EN 55022 Curve B, Quasi-Peak EMC limit, as shown in the following plots. The following plots show positive and negative quasi peak and CISPR22 Average Limit B (green line) and Quasi Peak Limit B (pink line) adherence limits.

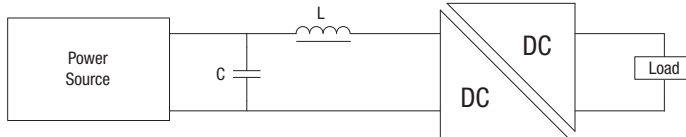

	Inductor			Capacitor C, $\mu$ F
	L, $\mu$ H	SMD	Through Hole	
MEE1S0303XC	10	82103C	11R103C	1
MEE1S0305XC	10	82103C	11R103C	1
MEE1S0309XC	10	82103C	11R103C	1
MEE1S0312XC	10	82103C	11R103C	1
MEE1S0315XC	10	82103C	11R103C	1
MEE1S0503XC	10	82103C	11R103C	0.68
MEE1S0505XC	10	82103C	11R103C	0.68
MEE1S0509XC	10	82103C	11R103C	0.68
MEE1S0512XC	10	82103C	11R103C	0.68
MEE1S0515XC	10	82103C	11R103C	0.68
MEE1S1205XC	10	82103C	11R103C	0.68
MEE1S1209XC	10	82103C	11R103C	0.68
MEE1S1212XC	10	82103C	11R103C	2.2
MEE1S1215XC	10	82103C	11R103C	2.2
MEE1S1505XC	10	82103C	11R103C	2.2
MEE1S1509XC	10	82103C	11R103C	2.2
MEE1S1512XC	10	82103C	11R103C	2.2
MEE1S1515XC	10	82103C	11R103C	2.2
MEE1S2405XC	10	82103C	11R103C	4.7
MEE1S2409XC	10	82103C	11R103C	4.7
MEE1S2412XC	10	82103C	11R103C	4.7
MEE1S2415XC	10	82103C	11R103C	4.7

**MEE1S0303XC**

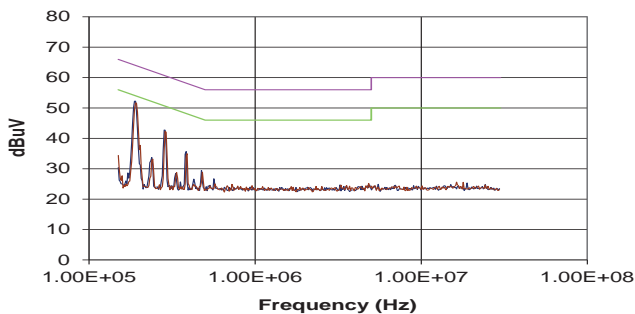

**MEE1S0305XC**

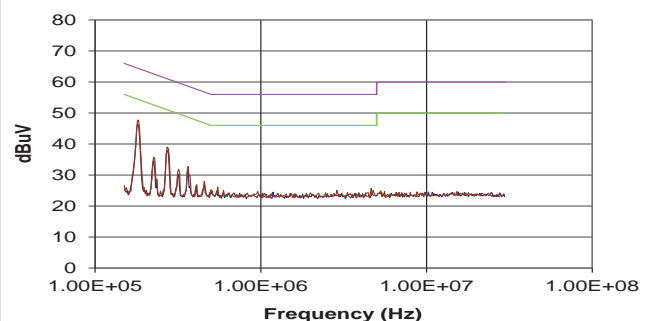

EMC FILTERING AND SPECTRA (Continued)

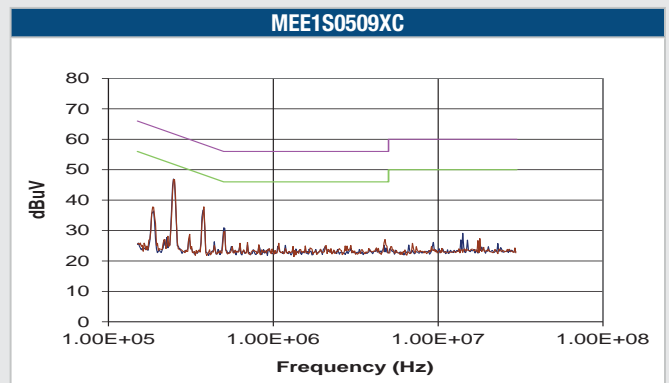
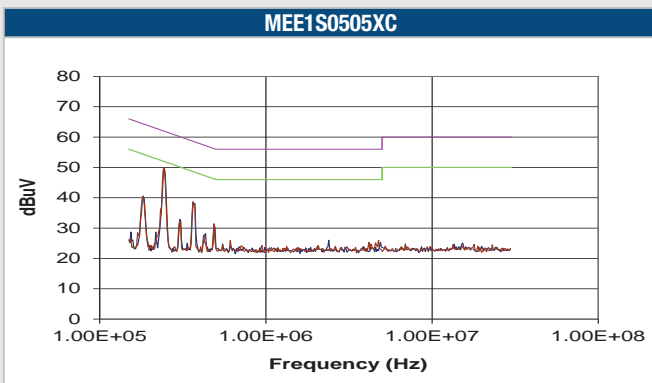
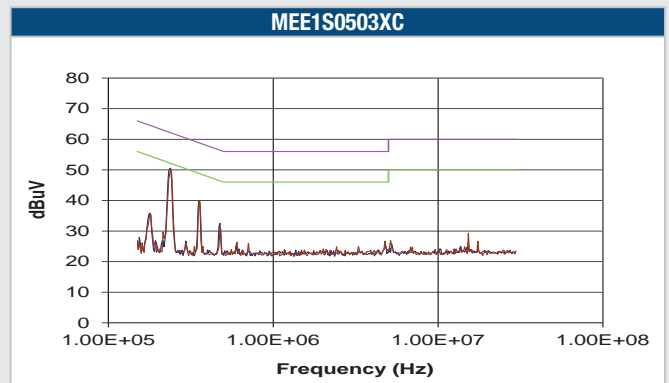
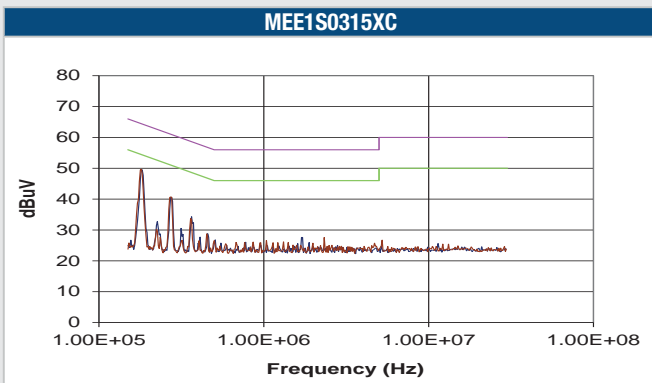
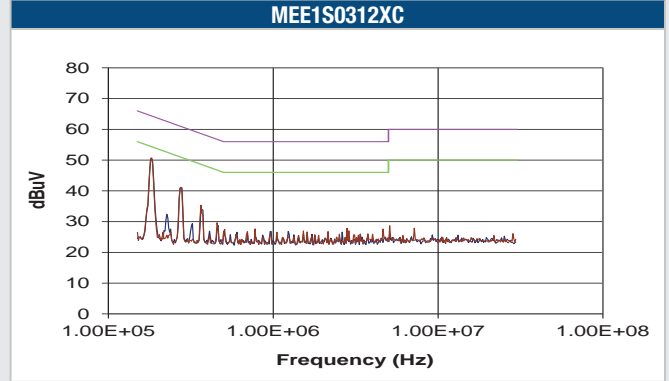
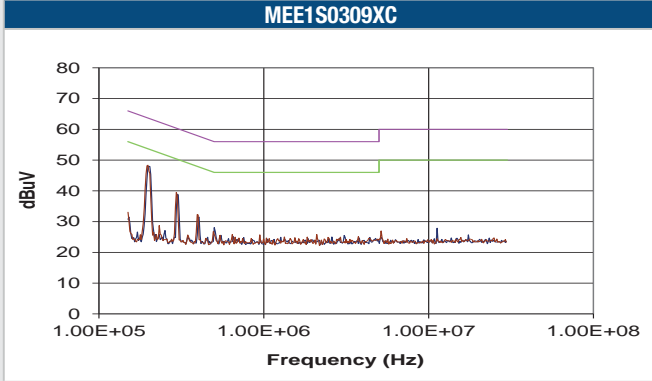

EMC FILTERING AND SPECTRA (Continued)

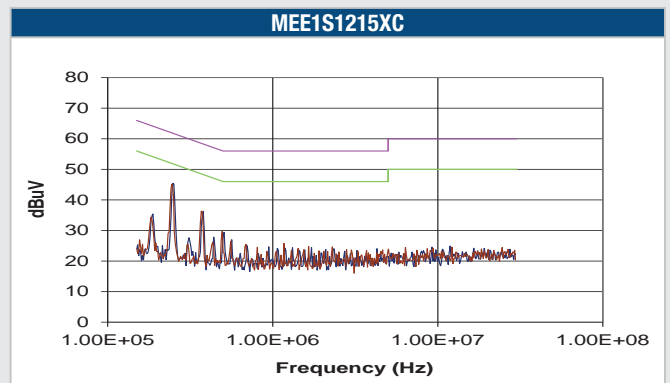
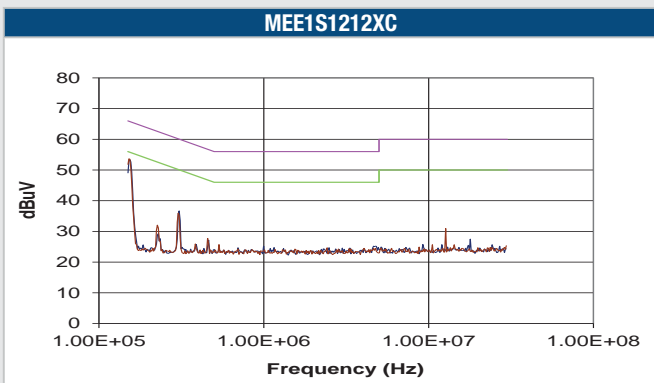
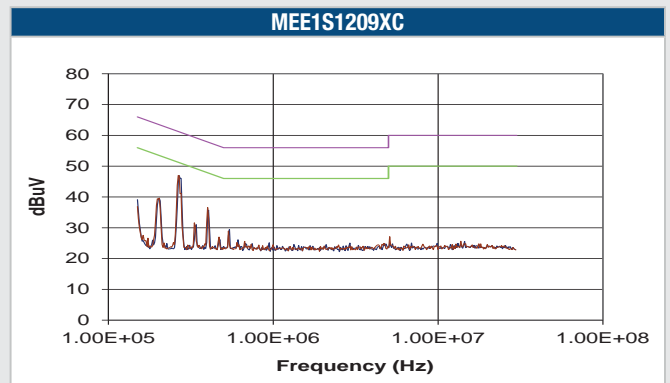
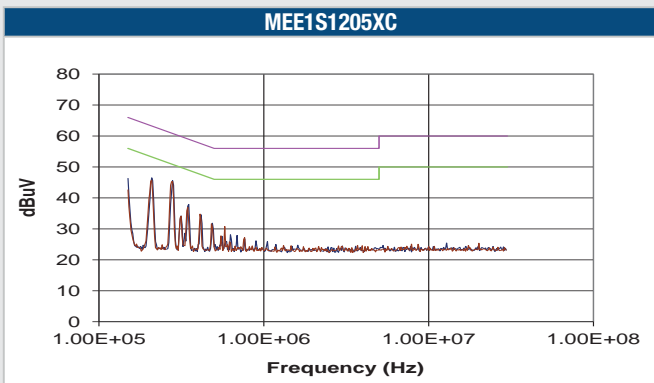
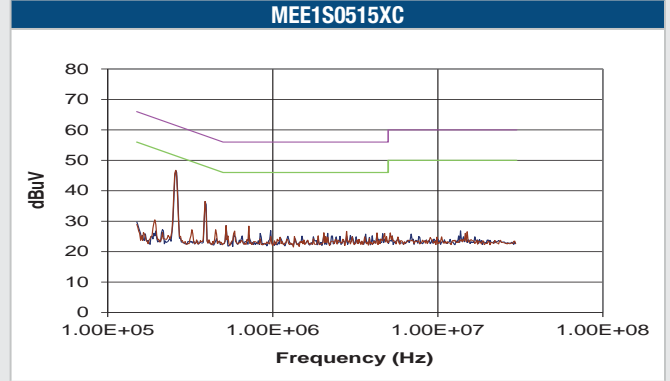
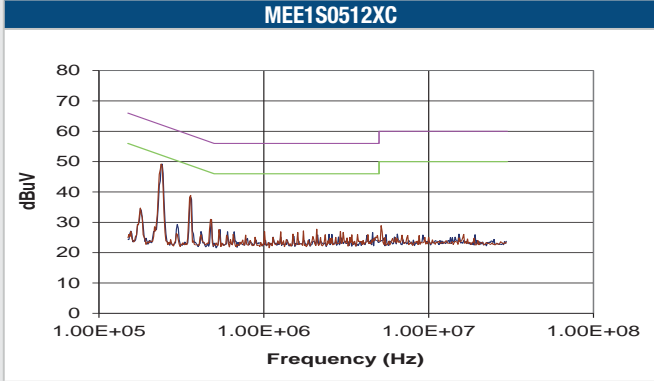

EMC FILTERING AND SPECTRA (Continued)

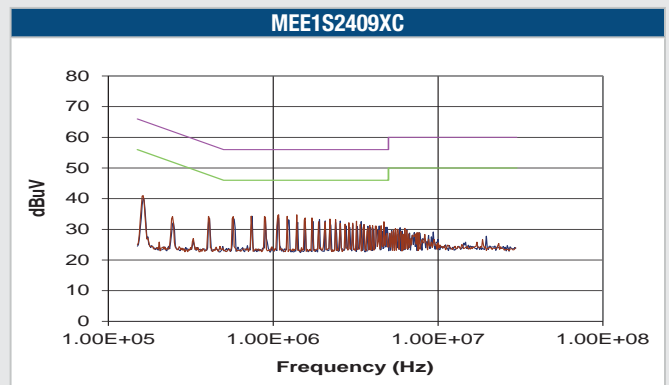
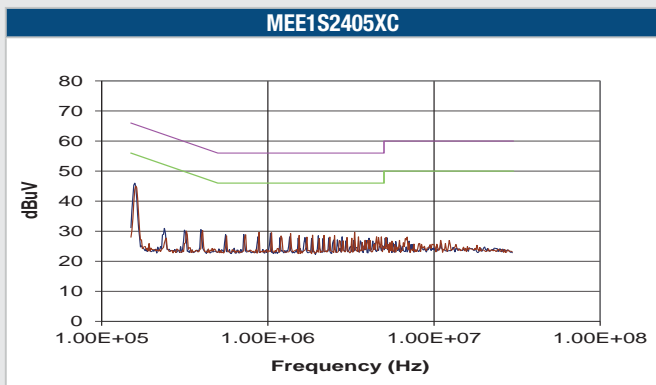
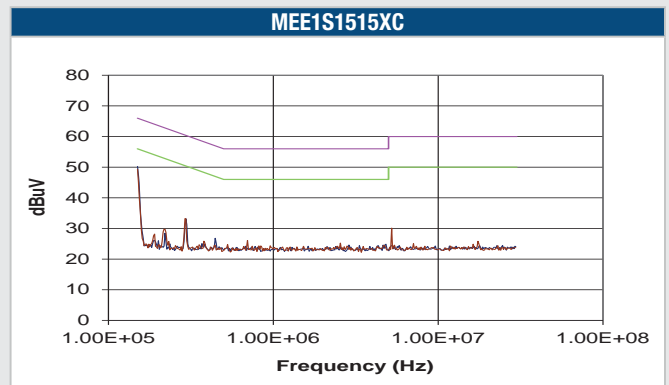
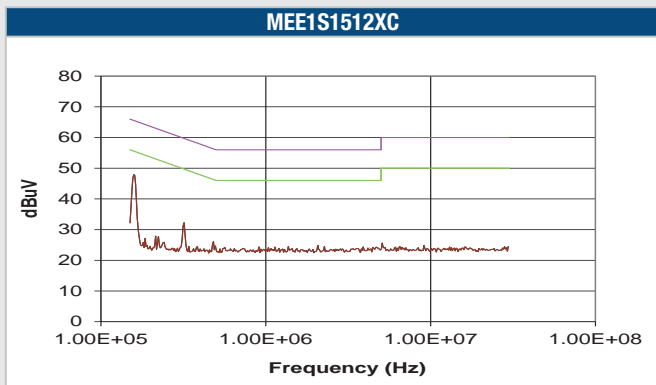
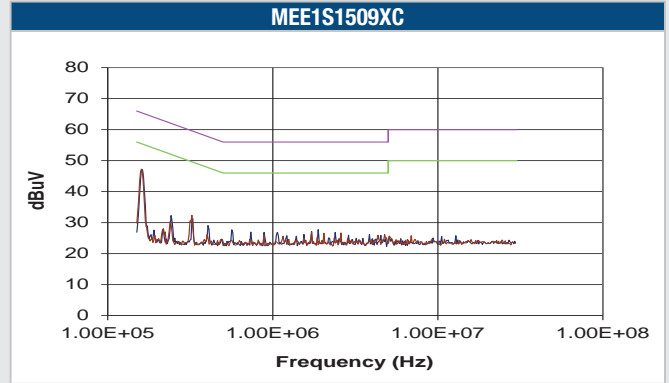
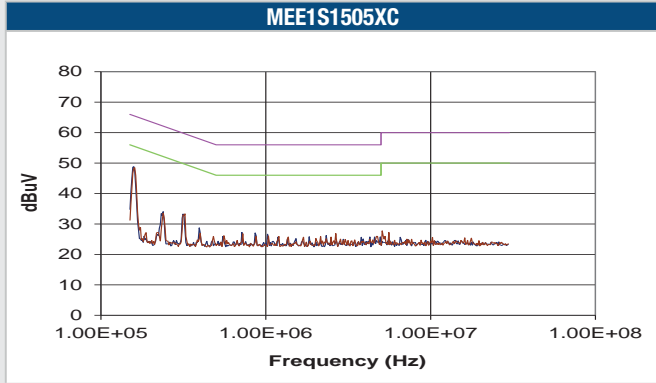

EMC FILTERING AND SPECTRA (Continued)

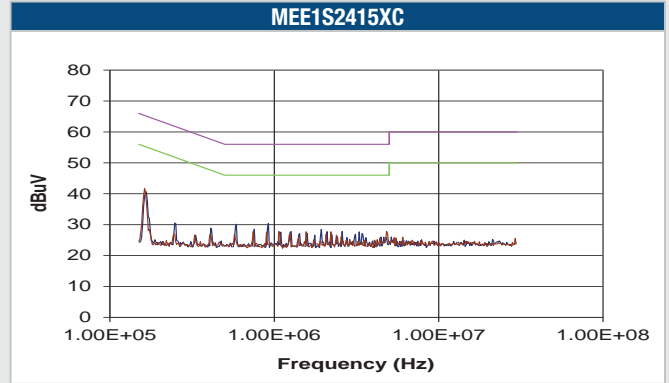
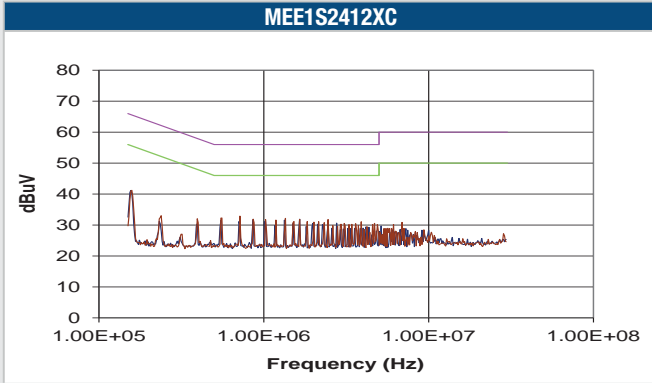

## PACKAGE SPECIFICATIONS

### MECHANICAL DIMENSIONS

#### DIP Package

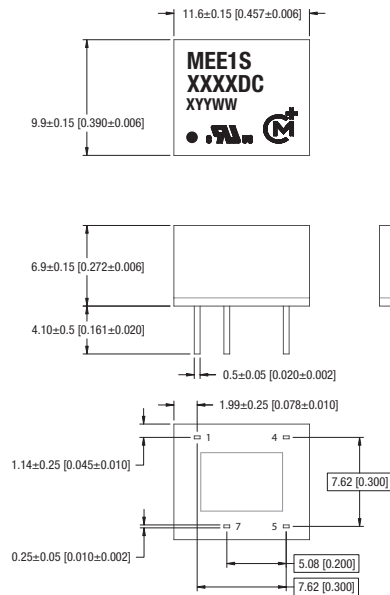

#### SIP Package

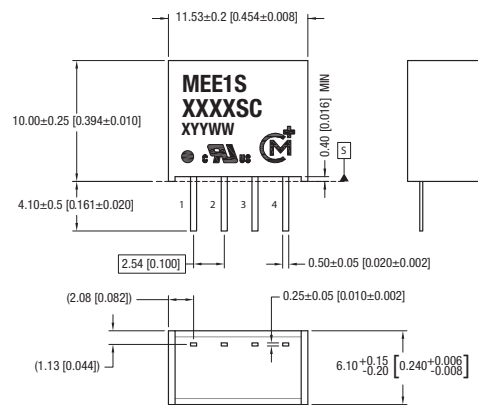

All dimensions in mm (inches) Controlling dimension is mm.  
 DIP: All pins on a 2.51 (0.100) pitch and within ±0.25 (0.010) of true position  
 SIP: All pins on a 2.54 (0.100) pitch and within ±0.1 (0.004) of true position from pin 1 at seating plane 'S'

Weight: 1.28g (SIP), 1.56g (DIP)

### PIN CONNECTIONS - 8 PIN DIP

Pin	Function
1	-VIN
4	+VIN
5	+VOUT
7	-VOUT

### PIN CONNECTIONS - 4 PIN SIP

Pin	Function
1	-VIN
2	+VIN
3	-VOUT
4	+VOUT

**PACKAGE SPECIFICATIONS (Continued)**

**RECOMMENDED FOOTPRINT DETAILS**

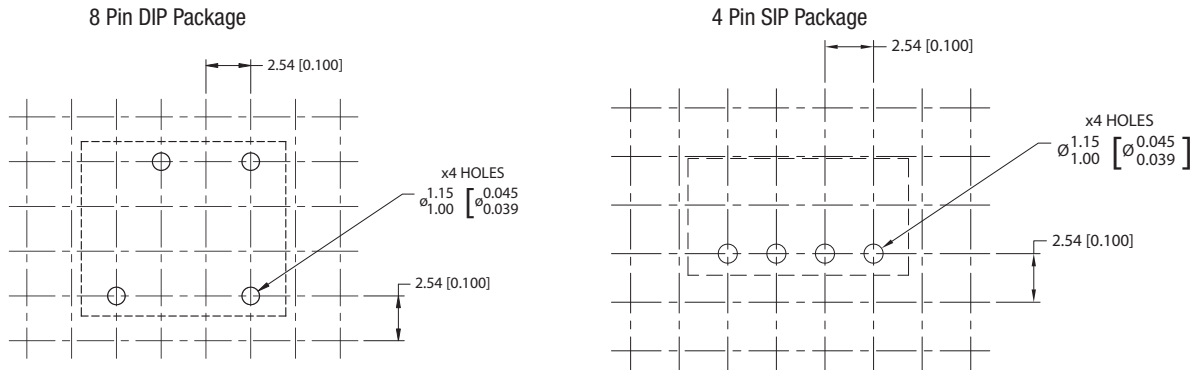

**TUBE OUTLINE DIMENSIONS**

**8 Pin DIP Tube**

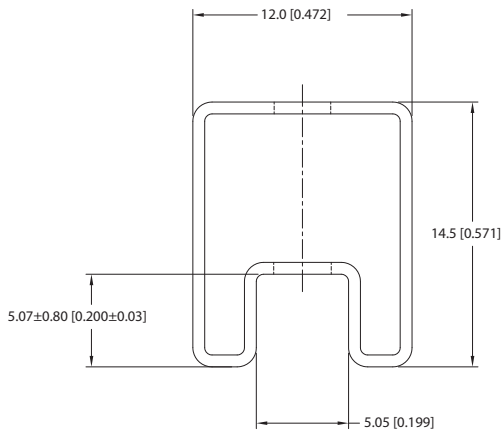

**4 Pin SIP Tube**

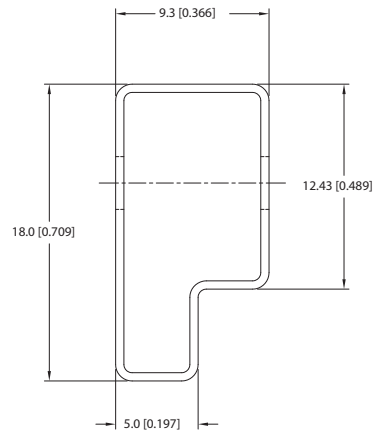

Unless otherwise stated all dimensions in mm (inches) ±0.5mm.  
 Tube length (8 Pin DIP) : 520mm ±2mm (20.47).  
 Tube length (4 Pin SIP) : 520mm ±2mm (20.47).

Tube Quantity : 35

**DISCLAIMER**

Unless otherwise stated in the datasheet, all products are designed for standard commercial and industrial applications and NOT for safety-critical and/or life-critical applications.

Particularly for safety-critical and/or life-critical applications, i.e. applications that may directly endanger or cause the loss of life, inflict bodily harm and/or loss or severe damage to equipment/property, and severely harm the environment, a prior explicit written approval from Murata is strictly required. Any use of Murata standard products for any safety-critical, life-critical or any related applications without any prior explicit written approval from Murata shall be deemed unauthorised use.

These applications include but are not limited to:

- Aircraft equipment
- Aerospace equipment
- Undersea equipment
- Power plant control equipment
- Medical equipment
- Transportation equipment ( automobiles, trains, ships, etc.)
- Traffic signal equipment
- Disaster prevention / crime prevention equipment
- Data Processing equipment

Murata makes no express or implied warranty, representation, or guarantee of suitability, fitness for any particular use/purpose and/or compatibility with any application or device of the buyer, nor does Murata assume any liability whatsoever arising out of unauthorised use of any Murata product for the application of the buyer. The suitability, fitness for any particular use/purpose and/or compatibility of Murata product with any application or device of the buyer remain to be the responsibility and liability of the buyer.

Buyer represents and agrees that it has all the necessary expertise to create and implement safeguards that anticipate dangerous consequences of failures, monitor failures and their consequences, lessen the likelihood of failures that might cause harm, and take appropriate remedial actions. Buyer will fully indemnify and hold Murata, its affiliated companies, and its representatives harmless against any damages arising out of unauthorised use of any Murata products in any safety-critical and/or life-critical applications.

Remark: Murata in this section refers to Murata Manufacturing Company and its affiliated companies worldwide including, but not limited to, Murata Power Solutions.



This product is subject to the following [operating requirements](#) and the [Life and Safety Critical Application Sales Policy](#):

Refer to: <https://www.murata.com/en-eu/products/power/requirements>

Murata Power Solutions (Milton Keynes) Ltd. makes no representation that the use of its products in the circuits described herein, or the use of other technical information contained herein, will not infringe upon existing or future patent rights. The descriptions contained herein do not imply the granting of licenses to make, use, or sell equipment constructed in accordance therewith. Specifications are subject to change without notice. © 2020 Murata Power Solutions (Milton Keynes) Ltd.



单击下面可查看定价，库存，交付和生命周期等信息

[>>Murata\(村田\)](#)