

### FEATURES

- Efficiency up to 80%
- Wide temperature performance at full 1 Watt load, -40°C to 85°C
- Dual output from a single input rail
- Industry standard pinout
- Power sharing on output
- 1kVDC isolation 'Hi Pot Test'
- 5V, 12V & 15V inputs
- 5V, 9V, 12V & 15V outputs
- Internal SMD construction
- Fully encapsulated with toroidal magnetics
- No external components required
- MTTF up to 3.1 million hours
- Pin compatible with NKA & MEA1 series
- No electrolytic or tantalum capacitors

### DESCRIPTION

The NMA series of industrial temperature range DC-DC converters are the standard building blocks for on-board distributed power systems. They are ideally suited for providing dual rail supplies on primarily digital boards with the added benefit of galvanic isolation to reduce switching noise. All of the rated power may be drawn from a single pin provided the total load does not exceed 1 watt.

### SELECTION GUIDE

Order Code	Nominal Input Voltage	Output Voltage	Output Current	Input Current at Rated Load	Efficiency	Isolation Capacitance	MTTF <sup>1</sup>	Package Style	Recommended Alternative
	V	V	mA	mA	%	pF	kHrs		
<span style="border: 1px solid green; padding: 2px;">Recommended</span> <span style="border: 1px solid blue; padding: 2px; margin-left: 20px;">In Production</span>									
NMA0505DC	5	±5	±100	289	69	28	3103	DIP	
NMA0509DC	5	±9	±55	267	75	32	2257		
NMA0512DC	5	±12	±42	260	77	34	1579		
NMA0515DC	5	±15	±33	256	78	36	1065	SIP	
NMA0505SC	5	±5	±100	289	69	28	3103		
NMA0509SC	5	±9	±55	267	75	32	2257		
NMA0512SC	5	±12	±42	260	77	34	1579	DIP	
NMA0515SC	5	±15	±33	256	78	36	1065		
NMA1205DC	12	±5	±100	120	69	33	2193		
NMA1212DC	12	±12	±42	111	75	55	1303	SIP	
NMA1215DC	12	±15	±33	110	76	54	932		
NMA1205SC	12	±5	±100	120	69	33	2193		
NMA1209SC	12	±9	±55	113	74	46	1734	DIP	
NMA1212SC	12	±12	±42	111	75	55	1303		
NMA1215SC	12	±15	±33	110	76	54	932		
NMA1505SC	15	±5	±100	91	71	39	1941	SIP	
NMA1512SC	15	±12	±42	87	78	68	790		
NMA1515SC	15	±15	±33	84	80	84	523		
<span style="background-color: red; color: white; padding: 2px;">To be discontinued</span>									
NMA1209DC	12	±9	±55	113	74	46	1734	DIP	NKA1209SC
NMA1505DC	15	±5	±100	91	71	39	1941		
NMA1505SC	15	±5	±100	91	71	39	1941	SIP	Contact Murata
NMA1512DC	15	±12	±42	87	78	68	790	DIP	NMV1512SC
NMA1515DC	15	±15	±33	84	80	84	523		

### INPUT CHARACTERISTICS

Parameter	Conditions	Min.	Typ.	Max.	Units
Voltage range	Continuous operation, 5V input types	4.5	5	5.5	V
	Continuous operation, 12V input types	10.8	12	13.2	
	Continuous operation, 15V input types	13.5	15	16.5	
Reflected ripple current			20	40	mA p-p

1. Calculated using MIL-HDBK-217FN2 calculation model with nominal input voltage at full load.  
All specifications typical at T<sub>a</sub>=25°C, nominal input voltage and rated output current unless otherwise specified.



For full details go to  
[www.murata-ps.com/rohs](http://www.murata-ps.com/rohs)

OUTPUT CHARACTERISTICS					
Parameter	Conditions	Min.	Typ.	Max.	Units
Rated Power	$T_A = -40^\circ\text{C}$ to $120^\circ\text{C}$ , see derating graph			1	W
Voltage Set Point Accuracy	See tolerance envelope				
Line regulation	High $V_{IN}$ to low $V_{IN}$		1.0	1.2	%/%
Load Regulation 10% load to rated load	5V & 12V input	5V output types	10	12.5	%
		9V output types	9	10	
		12V output types	6.5	7.5	
	15V input	15V output types	6	7.0	
		5V output types	5.5	10	
		12V output types	2.6	3.0	
Ripple and Noise <sup>1</sup>	BW=DC to 20MHz, 5V output types		10	20	mV p-p
	BW=DC to 20MHz, 9V output types		7	15	
	BW=DC to 20MHz, 12V output types		7.5	15	
	BW=DC to 20MHz, 15V output types		8	15	

ISOLATION CHARACTERISTICS					
Parameter	Conditions	Min.	Typ.	Max.	Units
Isolation test voltage	Flash tested for 1 second	1000			VDC
Resistance	Viso= 1000VDC		10		GΩ

GENERAL CHARACTERISTICS					
Parameter	Conditions	Min.	Typ.	Max.	Units
Switching frequency	5V input types		110		kHz
	12V input types		140		
	15V input types		90		

TEMPERATURE CHARACTERISTICS					
Parameter	Conditions	Min.	Typ.	Max.	Units
Specification	All output types	-40		85	°C
Storage		-50		130	
Case Temperature above ambient	0505, 1205		33		
	0509, 0512, 0515, 1209, 1212, 1215		28		
	1505		26		
Cooling	Free air convection		17		

ABSOLUTE MAXIMUM RATINGS	
Lead temperature 1.5mm from case for 10 seconds	260°C
Wave Solder	Wave Solder profile not to exceed the profile recommended in IEC 61760-1 Section 6.1.3. Please refer to <a href="#">application notes</a> for further information.
Input voltage $V_{IN}$ , NMA05 types	7V
Input voltage $V_{IN}$ , NMA12 types	15V
Input voltage $V_{IN}$ , NMA15 types	18V

1. See Ripple & Noise characterisation method.

### TECHNICAL NOTES

#### ISOLATION VOLTAGE

'Hi Pot Test', 'Flash Tested', 'Withstand Voltage', 'Proof Voltage', 'Dielectric Withstand Voltage' & 'Isolation Test Voltage' are all terms that relate to the same thing, a test voltage, applied for a specified time, across a component designed to provide electrical isolation, to verify the integrity of that isolation.

Murata Power Solutions NMA series of DC-DC converters are all 100% production tested at their stated isolation voltage. This is 1kVDC for 1 second.

A question commonly asked is, "What is the continuous voltage that can be applied across the part in normal operation?"

For a part holding no specific agency approvals, such as the NMA series, both input and output should normally be maintained within SELV limits i.e. less than 42.4V peak, or 60VDC. The isolation test voltage represents a measure of immunity to transient voltages and the part should never be used as an element of a safety isolation system. The part could be expected to function correctly with several hundred volts offset applied continuously across the isolation barrier; but then the circuitry on both sides of the barrier must be regarded as operating at an unsafe voltage and further isolation/insulation systems must form a barrier between these circuits and any user-accessible circuitry according to safety standard requirements.

#### REPEATED HIGH-VOLTAGE ISOLATION TESTING

It is well known that repeated high-voltage isolation testing of a barrier component can actually degrade isolation capability, to a lesser or greater degree depending on materials, construction and environment. The NMA series has toroidal isolation transformers, with no additional insulation between primary and secondary windings of enamelled wire. While parts can be expected to withstand several times the stated test voltage, the isolation capability does depend on the wire insulation. Any material, including this enamel (typically polyurethane) is susceptible to eventual chemical degradation when subject to very high applied voltages thus implying that the number of tests should be strictly limited. We therefore strongly advise against repeated high voltage isolation testing, but if it is absolutely required, that the voltage be reduced by 20% from specified test voltage.

This consideration equally applies to agency recognised parts rated for better than functional isolation where the wire enamel insulation is always supplemented by a further insulation system of physical spacing or barriers.

### RoHS COMPLIANT INFORMATION



This series is compatible with RoHS soldering systems with a peak wave solder temperature of 260°C for 10 seconds. Please refer to [application notes](#) for further information. The pin termination finish on the SIP package type is Tin Plate, Hot Dipped over Matte Tin with Nickel Preplate. The DIP types are Matte Tin over Nickel Preplate. Both types in this series are backward compatible with Sn/Pb soldering systems. For further information, please visit [www.murata-ps.com/rohs](http://www.murata-ps.com/rohs)

### PART NUMBER STRUCTURE

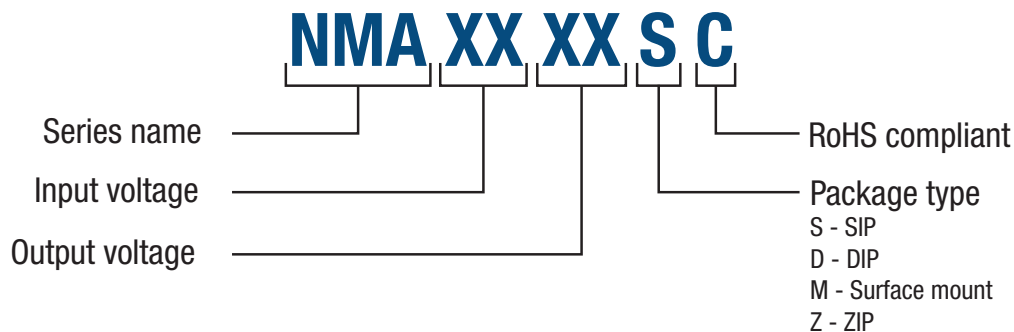

## CHARACTERISATION TEST METHODS

### Ripple & Noise Characterisation Method

Ripple and noise measurements are performed with the following test configuration.

C1	1µF X7R multilayer ceramic capacitor, voltage rating to be a minimum of 3 times the output voltage of the DC-DC converter
C2	10µF tantalum capacitor, voltage rating to be a minimum of 1.5 times the output voltage of the DC-DC converter with an ESR of less than 100mΩ at 100 kHz
C3	100nF multilayer ceramic capacitor, general purpose
R1	450Ω resistor, carbon film, ±1% tolerance
R2	50Ω BNC termination
T1	3T of the coax cable through a ferrite toroid
RLOAD	Resistive load to the maximum power rating of the DC-DC converter. Connections should be made via twisted wires

Measured values are multiplied by 10 to obtain the specified values.

### Differential Mode Noise Test Schematic

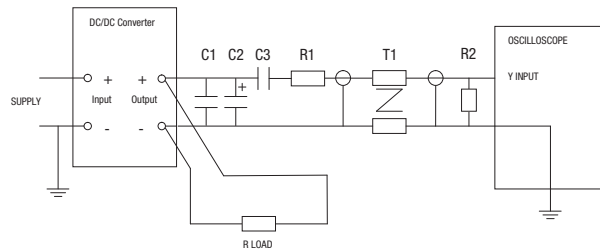

## APPLICATION NOTES

### Minimum load

The minimum load to meet datasheet specification is 10% of the full rated load across the specified input voltage range. Lower than 10% minimum loading will result in an increase in output voltage, which may rise to typically double the specified output voltage if the output load falls to less than 5%.

### Capacitive loading and start up

Typical start up times for this series, with a typical input voltage rise time of 2.2µs and output capacitance of 10µF, are shown in the table below. The product series will start into a capacitance of 47µF with an increased start time, however, the maximum recommended output capacitance is 10µF.

	Start-up time µs		Start-up time µs
NMA0505xC	2018	NMA1212xC	9765
NMA0509xC	6610	NMA1215xC	15980
NMA0512xC	14520	NMA1505xC	1060
NMA0515xC	20200	NMA1512xC	1627
NMA1205xC	1061	NMA1515xC	6275
NMA1209xC	3935		

Typical Start-Up Wave Form

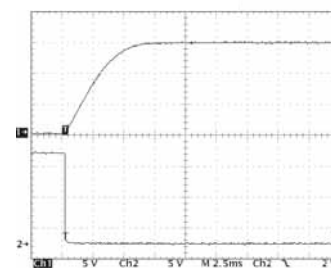

**APPLICATION NOTES (Continued)**

**Output Ripple Reduction**

By using the values of inductance and capacitance stated, the output ripple at the rated load is lowered to 5mV p-p max.

**Component selection**

**Capacitor:** It is required that the ESR (Equivalent Series Resistance) should be as low as possible, ceramic types are recommended. The voltage rating should be at least twice (except for 15V output), the rated output voltage of the DC-DC converter.

**Inductor:** The rated current of the inductor should not be less than that of the output of the DC-DC converter. At the rated current, the DC resistance of the inductor should be such that the voltage drop across the inductor is <2% of the rated voltage of the DC-DC converter. The SRF (Self Resonant Frequency) should be >20MHz.

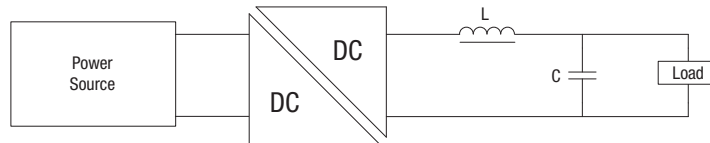

	Inductor			Capacitor
	L, $\mu$ H	SMD	Through Hole	C, $\mu$ F
NMA0505xC	22	82223C	11R223C	2.2 $\mu$ F
NMA0509xC	100	82104C	11R104C	0.47 $\mu$ F
NMA0512xC	150	82154C	11R154C	0.33 $\mu$ F
NMA0515xC	220	82224C	11R224C	1 $\mu$ F
NMA1205xC	22	82223C	11R223C	2.2 $\mu$ F
NMA1209xC	47	82473C	11R473C	1 $\mu$ F
NMA1212xC	150	82154C	11R154C	0.33 $\mu$ F
NMA1215xC	220	82224C	11R224C	1 $\mu$ F
NMA1505xC	22	82223C	11R223C	2.2 $\mu$ F
NMA1512xC	150	82154C	11R154C	0.33 $\mu$ F
NMA1515xC	220	82224C	11R224C	2.2 $\mu$ F

## TOLERANCE ENVELOPES

The voltage tolerance envelope shows typical load regulation characteristics for this product series. The tolerance envelope is the maximum output voltage variation due to changes in output loading.

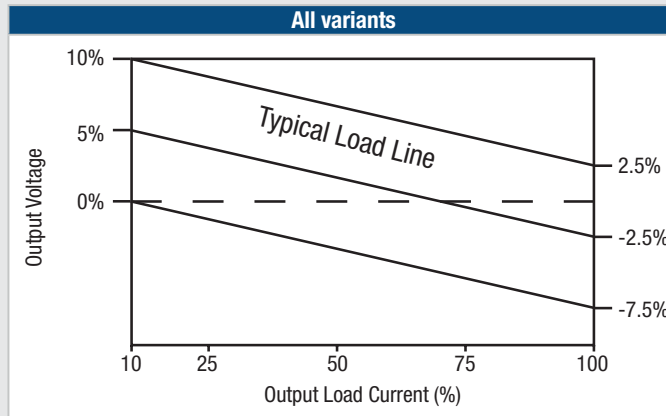

## TEMPERATURE DERATING GRAPH

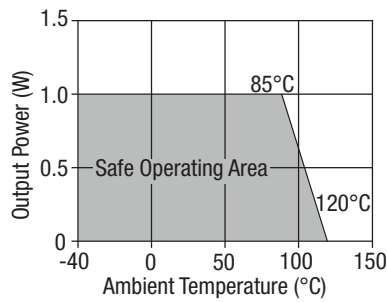

**PACKAGE SPECIFICATIONS**

**MECHANICAL DIMENSIONS**

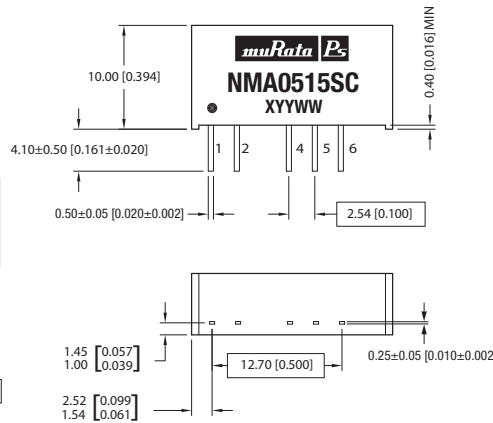
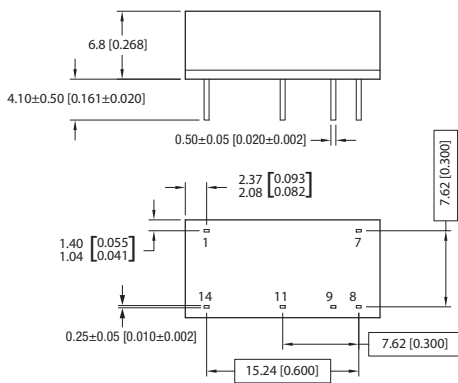
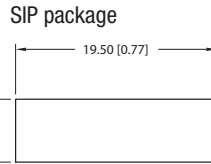
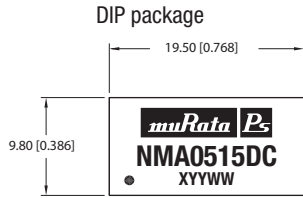

Controlling dimension is mm.

Unless otherwise stated all dimensions in mm (inches)  $\pm 0.25\text{mm}$  (0.010").

All pins on a 2.54mm (0.100") pitch and within 0.25mm (0.010") of true position.

Weight: 2.4g (DIP) 2.1g (SIP)

**PIN CONNECTIONS - 14 PIN DIP**

Pin	Function
1	-VIN
7	NC
8	OV
9	+VOUT
11	-VOUT
14	+VIN

**PIN CONNECTIONS - 7 PIN SIP**

Pin	Function
1	+VIN
2	-VIN
4	-VOUT
5	OV
6	+VOUT

**PACKAGE SPECIFICATIONS (Continued)**

**RECOMMENDED FOOTPRINT DETAILS**

14 Pin DIP Package

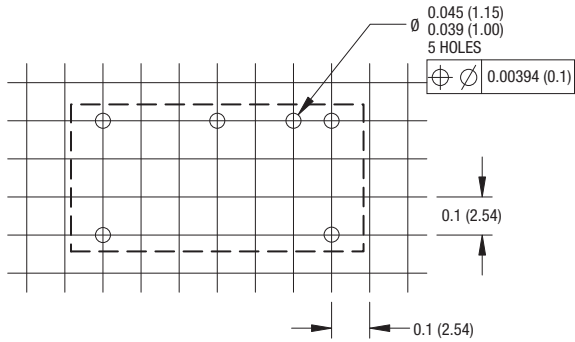

7 Pin SIP Package

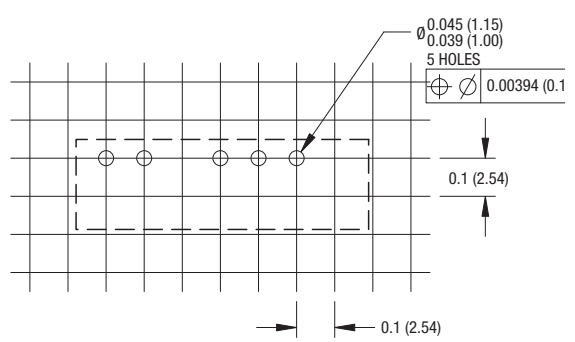

**TUBE OUTLINE DIMENSIONS**

14 Pin DIP Tube

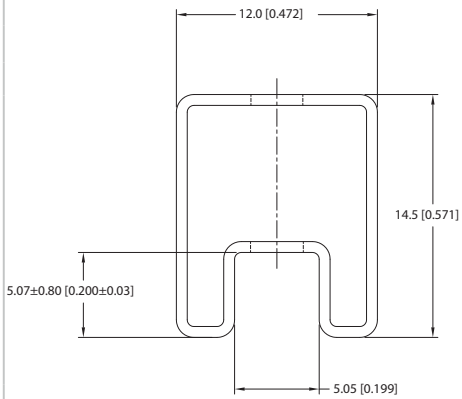

7 Pin SIP Tube

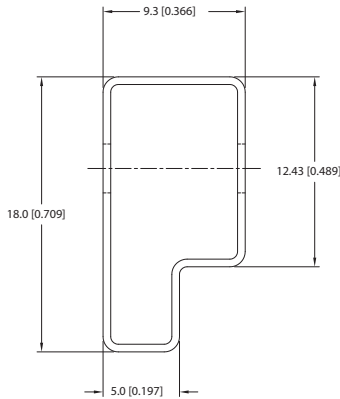

Unless otherwise specified all dimensions in mm [inches] ±0.55mm [0.022].  
 Tube length (14 Pin DIP) : 520mm [20.472] ±2.0 [0.079].  
 Tube length (7 Pin SIP) : 520mm [20.472] ±2.0 [0.079].

Tube Quantity : 25



**DISCLAIMER**

Unless otherwise stated in the datasheet, all products are designed for standard commercial and industrial applications and NOT for safety-critical and/or life-critical applications.

Particularly for safety-critical and/or life-critical applications, i.e. applications that may directly endanger or cause the loss of life, inflict bodily harm and/or loss or severe damage to equipment/property, and severely harm the environment, a prior explicit written approval from Murata is strictly required. Any use of Murata standard products for any safety-critical, life-critical or any related applications without any prior explicit written approval from Murata shall be deemed unauthorised use.

These applications include but are not limited to:

- Aircraft equipment
- Aerospace equipment
- Undersea equipment
- Power plant control equipment
- Medical equipment
- Transportation equipment ( automobiles, trains, ships, etc.)
- Traffic signal equipment
- Disaster prevention / crime prevention equipment
- Data Processing equipment

Murata makes no express or implied warranty, representation, or guarantee of suitability, fitness for any particular use/purpose and/or compatibility with any application or device of the buyer, nor does Murata assume any liability whatsoever arising out of unauthorised use of any Murata product for the application of the buyer. The suitability, fitness for any particular use/purpose and/or compatibility of Murata product with any application or device of the buyer remain to be the responsibility and liability of the buyer.

Buyer represents and agrees that it has all the necessary expertise to create and implement safeguards that anticipate dangerous consequences of failures, monitor failures and their consequences, lessen the likelihood of failures that might cause harm, and take appropriate remedial actions. Buyer will fully indemnify and hold Murata, its affiliated companies, and its representatives harmless against any damages arising out of unauthorised use of any Murata products in any safety-critical and/or life-critical applications.

Remark: Murata in this section refers to Murata Manufacturing Company and its affiliated companies worldwide including, but not limited to, Murata Power Solutions.



This product is subject to the following [operating requirements](#) and the [Life and Safety Critical Application Sales Policy](#):

Refer to: <https://www.murata.com/en-eu/products/power/requirements>

Murata Power Solutions (Milton Keynes) Ltd. makes no representation that the use of its products in the circuits described herein, or the use of other technical information contained herein, will not infringe upon existing or future patent rights. The descriptions contained herein do not imply the granting of licenses to make, use, or sell equipment constructed in accordance therewith. Specifications are subject to change without notice. © 2021 Murata Power Solutions (Milton Keynes) Ltd.

单击下面可查看定价，库存，交付和生命周期等信息

[>>Murata\(村田\)](#)