

SF2167E

1382.24 MHz SAW Filter

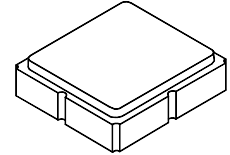

SM3030-8

- **SAW Filter for Digital Television**
- **Complies with Directive 2002/95/EC (RoHS)**



Characteristics :

Balance-to-balanced operation

Terminating source/load impedance: $Z_S = 150 \Omega$

Maximum Rating

Rating	Value	Units
Input Power Level	0	dBm
DC Voltage on any Non-ground Terminal	3	V
Operating Temperature Range	-40 to +85	°C
Storage Temperature Range	-50 to +95	°C
Maximum Soldering Profile, 5 cycles/ 10 seconds maximum	265	°C

Characteristic	Sym	Notes	Min	Typ	Max	Units
Center Frequency	f_C			1382.24		MHz
Insertion Loss, 1362.24 to 1402.24 MHz	IL			3.4	4.5	dB
Amplitude Ripple, 1362.24 to 1402.24 MHz				0.5	2.0	dB
Group Delay Ripple, 1362.24 to 1402.24 MHz				10	30	ns _{P-P}
Attenuation, 0 dB Reference:						
500 to 1300.18 MHz			42	52		dB
1464.30 to 1490 MHz			45	50		
1490 to 2000 MHz			40	50		

Case Style	SM3030-8 3.0 x 3.0 mm Nominal Footprint					
Lid Symbolization (Y=year, WW=week, S=shift) dot=pin 1 indicator	854, YWWS					
Standard Reel Quantity	Reel Size 7 inch					500 Pieces/Reel
	Reel Size 13 inch					3000 Pieces/Reel

Tuning Network, 150 ohm Balanced Source/Load

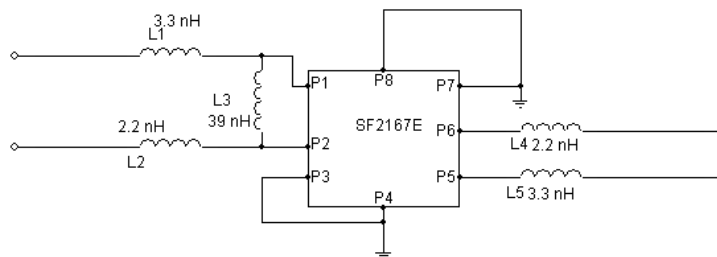

NOTES:

1. US and international patents may apply.
2. Murata, stylized Murata logo, and Murata N.A., Inc. are registered trademarks of Murata Manufacturing Co., Ltd.
3. Electrostatic Sensitive Device. Observe precautions for handling.

Filter Wideband S21, S11 and S22 Plots

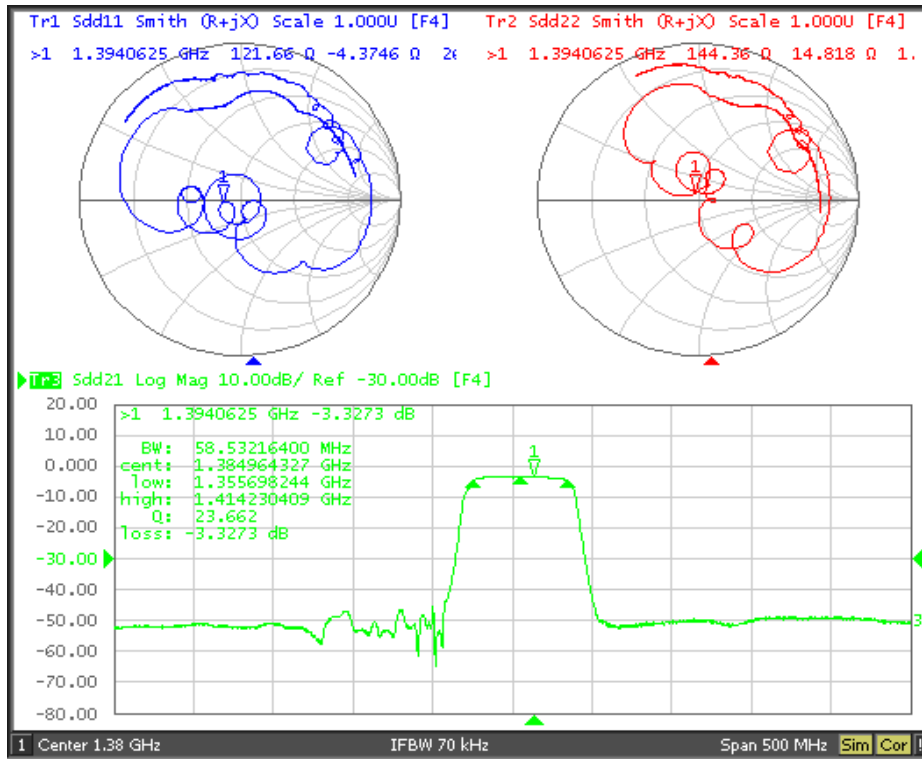

Filter Shape Factor Plot

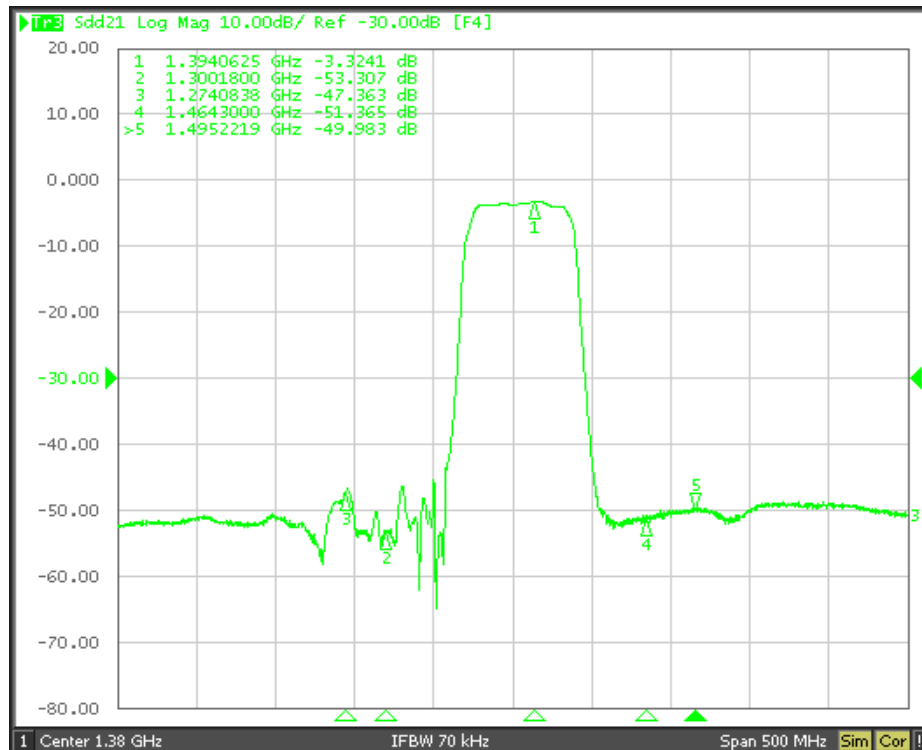

Filter Passband Plot

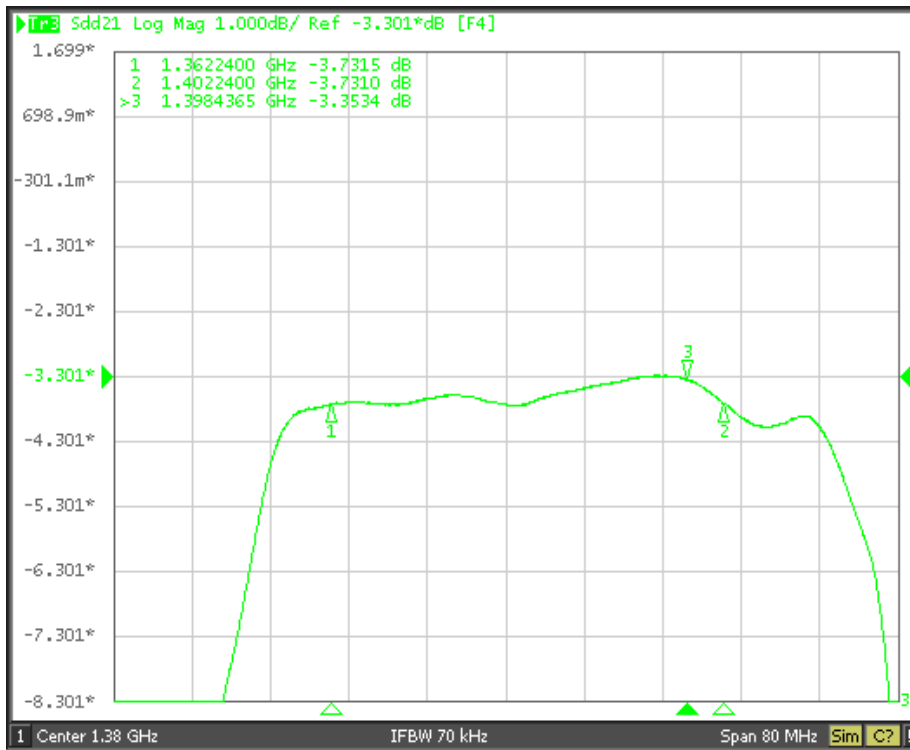

Filter Group Delay Plot

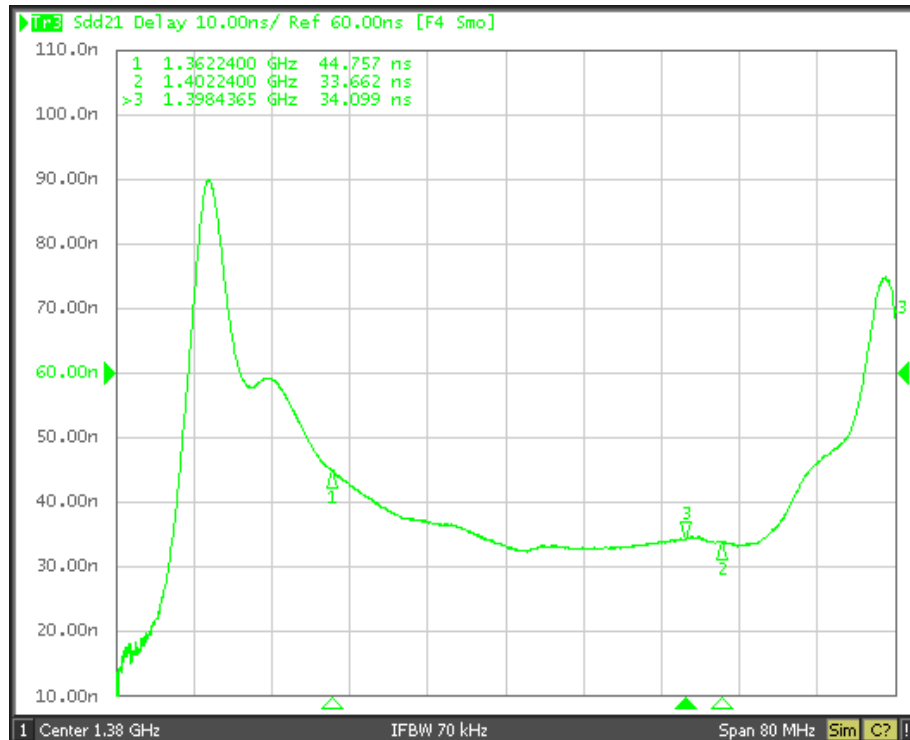

8-Terminal Ceramic Surface-Mount Case 3.0 X 3.0 mm Nominal Footprint

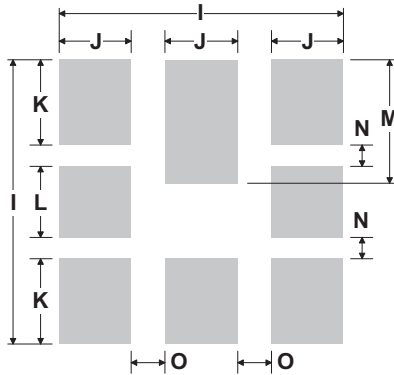
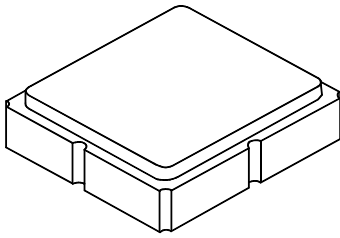

PCB Footprint Top View

Case and PCB Footprint Dimensions

Dimension	mm			Inches		
	Min	Nom	Max	Min	Nom	Max
A	2.87	3.0	3.13	0.113	0.118	0.123
B	2.87	3.0	3.13	0.113	0.118	0.123
C	1.14	1.27	1.40	0.045	0.050	0.055
D	0.79	0.92	1.05	0.031	0.036	0.041
E	0.62	0.75	0.88	0.024	0.029	0.034
F	0.47	0.60	0.73	0.018	0.024	0.029
G	0.47	0.60	0.73	0.018	0.024	0.029
H	1.07	1.20	1.33	0.042	0.047	0.052
I		3.19			0.126	
J		0.81			0.032	
K		0.96			0.038	
L		0.81			0.032	
M		1.39			0.055	
N		0.23			0.009	
O		0.38			0.015	

Case Materials

Materials	
Solder Pad Plating	0.3 to 1.0 μm Gold over 1.27 to 8.89 μm Nickel
Lid Plating	2.0 to 3.0 μm Nickel
Body	Al_2O_3 Ceramic
	Pb Free

TOP VIEW

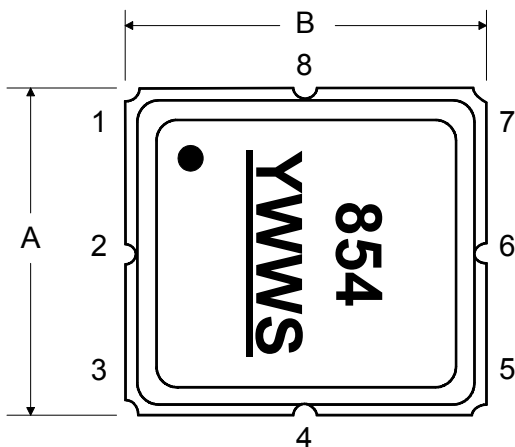

BOTTOM VIEW

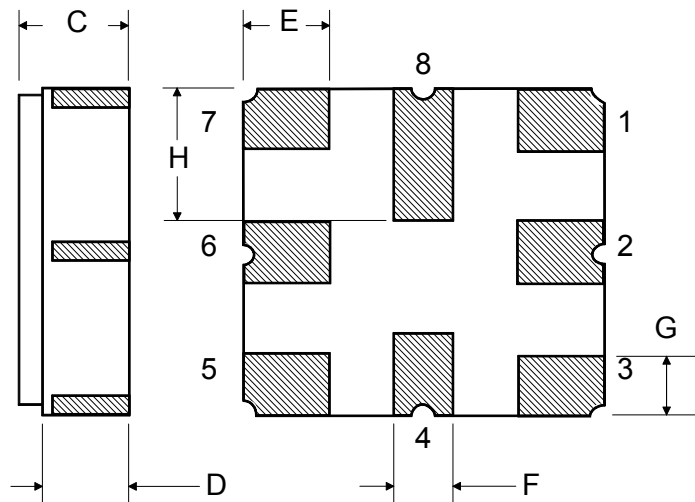

Tape and Reel Specifications

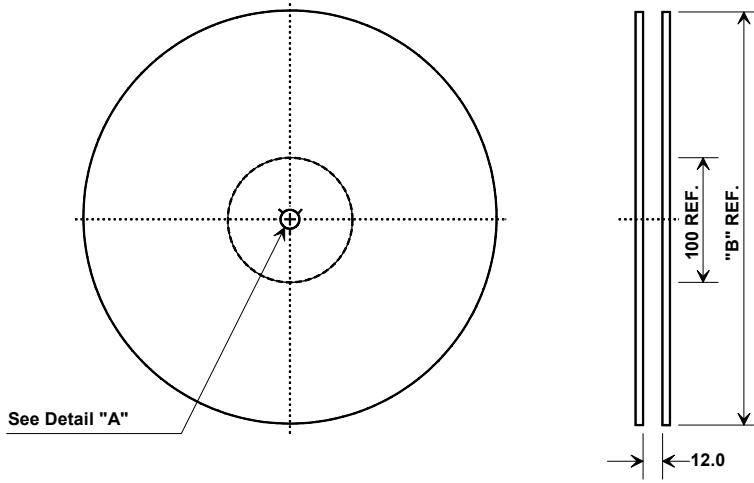

"B"		Quantity Per Reel
Inches	millimeters	
7	178	500
13	330	3000

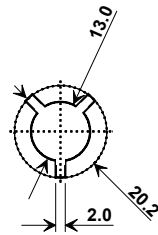

COMPONENT ORIENTATION and DIMENSIONS

Carrier Tape Dimensions	
Ao	3.35 mm
Bo	3.35 mm
Ko	1.40 mm
Pitch	8.0 mm
W	12.0 mm

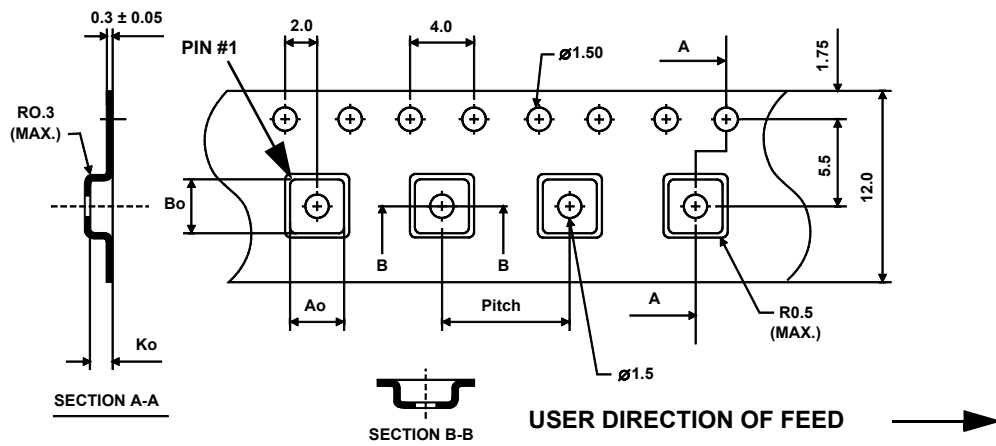

单击下面可查看定价，库存，交付和生命周期等信息

[>>Murata\(村田\)](#)