

Reference Specification

Type EA
Safety Standard Certified Resin Molding SMD Type Ceramic Capacitors for General Purpose

Product specifications in this catalog are as of Jun. 2020, and are subject to change or obsolescence without notice.
Please consult the approval sheet before ordering. Please read rating and Cautions first.

⚠ CAUTION**1. OPERATING VOLTAGE**

When DC-rated capacitors are to be used in AC or ripple current circuits, be sure to maintain the V_{p-p} value of the applied voltage or the V_{o-p} which contains DC bias within the rated voltage range. When the voltage is started to apply to the circuit or it is stopped applying, the irregular voltage may be generated for a transit period because of resonance or switching. Be sure to use a capacitor within rated voltage containing these irregular voltage.

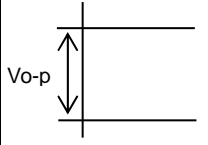
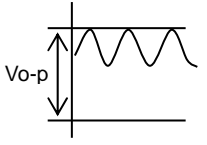
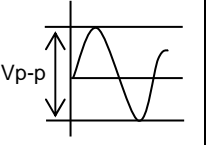
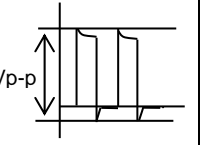
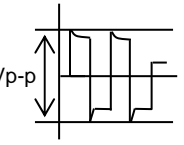
Voltage	DC Voltage	DC+AC Voltage	AC Voltage	Pulse Voltage(1)	Pulse Voltage(2)
Positional Measurement					

2. OPERATING TEMPERATURE AND SELF-GENERATED HEAT

Keep the surface temperature of a capacitor below the upper limit of its rated operating temperature range. Be sure to take into account the heat generated by the capacitor itself.

When the capacitor is used in a high-frequency current, pulse current or the like, it may have the self-generated heat due to dielectric-loss. Applied voltage should be the load such as self-generated heat is within 20 °C on the condition of atmosphere temperature 25 °C. When measuring, use a thermocouple of small thermal capacity-K of $\phi 0.1\text{mm}$ and be in the condition where capacitor is not affected by radiant heat of other components and wind of surroundings. Excessive heat may lead to deterioration of the capacitor's characteristics and reliability. (Never attempt to perform measurement with the cooling fan running. Otherwise, accurate measurement cannot be ensured.)

3. TEST CONDITION FOR WITHSTANDING VOLTAGE**(1) TEST EQUIPMENT**

Test equipment for AC withstanding voltage should be used with the performance of the wave similar to 50/60 Hz sine wave.

If the distorted sine wave or over load exceeding the specified voltage value is applied, the defective may be caused.

(2) VOLTAGE APPLIED METHOD

When the withstanding voltage is applied, capacitor's lead or terminal should be firmly connected to the out-put of the withstanding voltage test equipment, and then the voltage should be raised from near zero to the test voltage.

If the test voltage without the raise from near zero voltage would be applied directly to capacitor, test voltage should be applied with the *zero cross. At the end of the test time, the test voltage should be reduced to near zero, and then capacitor's lead or terminal should be taken off the out-put of the withstanding voltage test equipment.

If the test voltage without the raise from near zero voltage would be applied directly to capacitor, the surge voltage may arise, and therefore, the defective may be caused.

*ZERO CROSS is the point where voltage sine wave pass 0V.

- See the right figure -

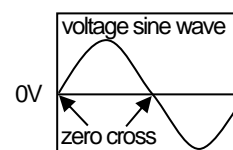
**4. FAIL-SAFE**

When capacitor would be broken, failure may result in a short circuit. Be sure to provide an appropriate fail-safe function like a fuse on your product if failure would follow an electric shock, fire or fume.

5. VIBRATION AND IMPACT

Do not expose a capacitor or its leads to excessive shock or vibration during use.

6. SOLDERING

6-1 Reflow Soldering

When soldering capacitor, it should be performed in following conditions.

Soldering temperature : 230 ~ 260 °C

Soldering time : 10 ~ 30s

Preheating temperature : 170 °C max.

6-2 Flow Soldering

When soldering capacitor, it should be performed in following conditions.

Soldering temperature : 260 °C max.

Soldering time : 5s max.

Preheating temperature : 120 °C max.

Preheating time : 60s max.

6-3 Soldering Iron

When soldering this product to a PCB/PWB, do not exceed the solder heat resistance specification of the capacitor. Subjecting this product to excessive heating could melt the internal junction solder and may result in thermal shocks that can crack the ceramic element.

When soldering capacitor with a soldering iron, it should be performed in following conditions.

Temperature of iron-tip : 400 °C max.

Soldering iron wattage : 50W max.

Soldering time : 3.5s max.

7. BONDING, RESIN MOLDING AND COATING

Before bonding, molding or coating this product, verify that these processes do not affect the quality of capacitor by testing the performance of the bonded, molded or coated product in the intended equipment.

In case of the amount of applications, dryness / hardening conditions of adhesives and molding resins containing organic solvents (ethyl acetate, methyl ethyl ketone, toluene, etc.) are unsuitable, the outer coating resin of a capacitor is damaged by the organic solvents and it may result, worst case, in a short circuit.

The variation in thickness of adhesive, molding resin or coating may cause a outer coating resin cracking and/or ceramic element cracking of a capacitor in a temperature cycling.

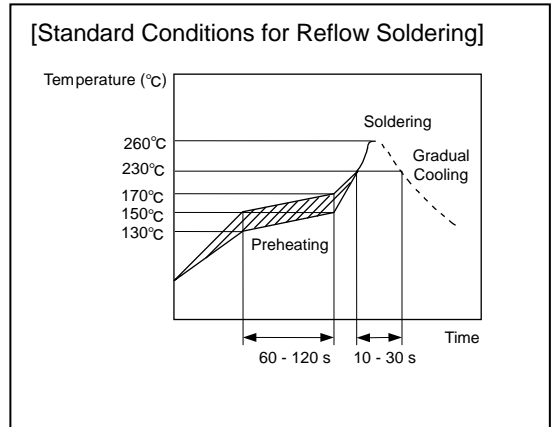

8. OPERATING AND STORAGE ENVIRONMENT

The insulation coating of capacitors does not form a perfect seal; therefore, do not use or store capacitors in a corrosive atmosphere, especially where chloride gas, sulfide gas, acid, alkali, salt or the like are present. And avoid exposure to moisture. Before cleaning, bonding, or molding this product, verify that these processes do not affect product quality by testing the performance of a cleaned, bonded or molded product in the intended equipment.

This one is MSL 3 product. So, in order to avoid the absorption of moisture, capacitors are packed in moisture-proof envelope.

Store the capacitors in the following conditions at all times, and use within 6 months after delivered.

Temperature : 10 to 30°C

Humidity : 60% max.

Solder the enclosed capacitors within 168 hours after opening the moisture-proof package.

After opening, store the capacitors in moisture-proof package with a desiccant and HIC card and keep the above condition.

In case the storage period has been exceeded 6 months or the indicator color of a enclosed HIC card has changed when the package has been opened, perform baking (60°C x 168 hr) before soldering.

9. LIMITATION OF APPLICATIONS

Please contact us before using our products for the applications listed below which require especially high reliability for the prevention of defects which might directly cause damage to the third party's life, body or property.

1. Aircraft equipment
2. Aerospace equipment
3. Undersea equipment
4. Power plant control equipment
5. Medical equipment
6. Transportation equipment (automotives, trains, ships, etc.)
7. Traffic signal equipment
8. Disaster prevention / crime prevention equipment
9. Data-processing equipment exerting influence on public
10. Application of similar complexity and/or reliability requirements to the applications listed in the above.

NOTICE**1. CLEANING (ULTRASONIC CLEANING)**

To perform ultrasonic cleaning, observe the following conditions.

Rinse bath capacity : Output of 20 watts per liter or less.

Rinsing time : 5 min maximum.

Do not vibrate the PCB/PWB directly.

Excessive ultrasonic cleaning may lead to fatigue destruction of the terminals.

2. CAPACITANCE CHANGE OF CAPACITORS

· Class 1 capacitors

Capacitance might change a little depending on a surrounding temperature or an applied voltage.

Please contact us if you use for the strict time constant circuit.

· Class 2 capacitors

Class 2 capacitors like temperature characteristic B, E and F have an aging characteristic, whereby the capacitor continually decreases its capacitance slightly if the capacitor leaves for a long time.

Moreover, capacitance might change greatly depending on a surrounding temperature or an applied voltage. So, it is not likely to be able to use for the time constant circuit.

Please contact us if you need a detail information.

3. PERFORMANCE CHECK BY EQUIPMENT

Before using a capacitor, check that there is no problem in the equipment's performance and the specifications.

Generally speaking, Class 2 ceramic capacitors have voltage dependence characteristics and temperature dependence characteristics in capacitance. So, the capacitance value may change depending on the operating condition in a equipment. Therefore, be sure to confirm the apparatus performance of receiving influence in a capacitance value change of a capacitor, such as leakage current and noise suppression characteristic.

Moreover, check the surge-proof ability of a capacitor in the equipment, if needed, because the surge voltage may exceed specific value by the inductance of the circuit.

4. Land Dimensions

The recommendable land dimensions for reflow soldering are follows.

Regarding the "a" dimension, to ensure the creepage distance required by the safety standard applies to your equipment.

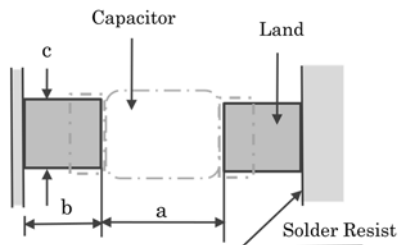

Dimension	a	b	c
8.0 x 6.0	8.0	2.2	3.6

⚠ NOTE

1. Please make sure that your product has been evaluated in view of your specifications with our product being mounted to your product.

2. You are requested not to use our product deviating from this specification.

1. Application

This specification is applied to Safety Standard Certified Resin Molding SMD Type Ceramic Capacitors Type EA used for General Electric equipment.

Type EA is Safety Standard Certified capacitors of Class X1, Y1.

Do not use these products in any automotive power train or safety equipment including battery charger for electric vehicles and plug-in hybrids.

Approval standard and recognized number

	Standard number	Certified number	AC Rated volt.
UL/cUL	UL60384-14	E37921	X1:AC440V(r.m.s.) Y1:AC250V(r.m.s.)
ENEC (SEMKO)	EN60384-14	SE/16008-1	
CQC	IEC60384-14	CQC16001142384	
KTC	KC60384-14	HU03008-16007	

2. Rating

2-1. Operating temperature range -40 ~ +125°C

2-2. Rated voltage

X1 : AC440V(r.m.s.)

Y1 : AC250V(r.m.s.)

DC1kV

2-3. Part number configuration

ex.) DK1 E3 EA 102 M 86 R AH01
 Product Temperature Type Capacitance Capacitance Size Packing Individual
 code characteristic name tolerance code style code specification

• Type name

DK1 denotes resin molding SMD type safety standard recognized ceramic capacitor of class Y1.

• Temperature characteristic

Code	Temperature characteristic
1X	SL
B3	B
E3	E

Please confirm detailed specification on [Specification and test method].

• Type name

This denotes safety recognized type name Type EA.

• Capacitance

The first two digits denote significant figures : the last digit denotes the multiplier of in pF.

ex.) In case of 102

$$10 \times 10^2 = 1000\text{pF}$$

• Capacitance tolerance

Please refer to [Part number list]

• Size code

code	Body size
86	8.0 X 6.0 mm

• Packing style code

code	Packing type
R	Φ330mm Reel type

• Individual specification

Murata's control code

Please refer to Part number list .

3. Marking

Type name : EA
Nominal capacitance : Actual value (under 100pF)
3 digit system (100pF and over)
Rated Voltage : X1 440~
Y1 250~
Company name code : M15 (Made in Thailand)
Manufacturing year : Letter code (The last digit of A.D. year.)
Manufacturing month : Code
ex.) YEAR MONTH
2015 11(November)
| 5N* |
*From January to September : "1" to "9",
October : "O" , November : "N" , December : "D"
KTC Approval mark : 

(Example)

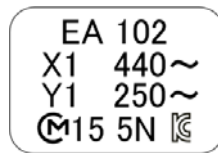

4. Part number list

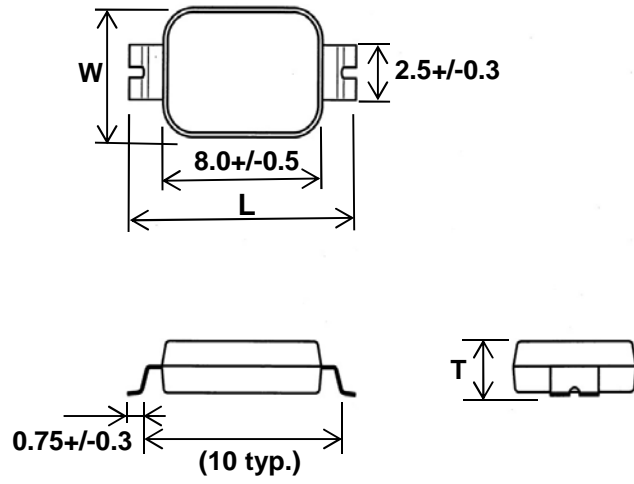

Unit : mm

T.C.	Cap. (pF)	Cap. Tol.	Customer Part Number	Murata Part Number	Dimension (mm)			Size code	Pack qty. (pcs)
					L	W	T max.		
SL	10	±10%		DK11XEA100K86RAH01	11.4±0.5	6.0±0.5	2.5	86	2500
SL	22	±10%		DK11XEA220K86RAH01	11.4±0.5	6.0±0.5	2.5	86	2500
SL	47	±10%		DK11XEA470K86RAH01	11.4±0.5	6.0±0.5	2.5	86	2500
B	100	±10%		DK1B3EA101K86RAH01	11.4±0.5	6.0±0.5	2.5	86	2500
B	220	±10%		DK1B3EA221K86RAH01	11.4±0.5	6.0±0.5	2.5	86	2500
B	330	±10%		DK1B3EA331K86RAH01	11.4±0.5	6.0±0.5	2.5	86	2500
B	470	±10%		DK1B3EA471K86RAH01	11.4±0.5	6.0±0.5	2.5	86	2500
B	680	±10%		DK1B3EA681K86RAH01	11.4±0.5	6.0±0.5	2.5	86	2500
E	1000	±20%		DK1E3EA102M86RAH01	11.4±0.5	6.0±0.5	2.5	86	2500
E	1500	±20%		DK1E3EA152M86RAH01	11.4±0.5	6.0±0.5	2.5	86	2500

■ Specification and test methods

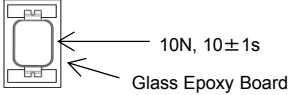
5. Specifications and test methods															
No.	Item	Specification	Test method												
1	Operating Temperature	-40~+125°C													
2	Appearance	No defects or abnormalities	Visual inspection.												
3	Dimensions	Within the specified dimension.	Using calipers and micrometers.												
4	Dielectric strength	No defects or abnormalities.	The capacitor shall not be damage when AC4000V(r.m.s.) is applied between the terminations for 60 s.												
5	Insulation Resistance(I.R.)	6000 MΩ or more	The insulation resistance shall be measured with DC500±50V within 60±5 s of charging. The voltage should be applied to the capacitor through a resistor of 1MΩ.												
6	Capacitance	Within the specified tolerance.	Capacitance/D.F. shall be measured at 20°C with the frequency of 1±0.2kHz and a voltage of AC1±0.2V(r.m.s.).												
7	Dissipation Factor (D.F.)	0.025 max.													
8	Capacitance Temperature Characteristics	Temp. Coefficient SL: +350 to -1000 ppm/°C (Temp. Range:+20 to +85°C) Cap. Change B:within ±10% E:within +20/-55% (Temp. Range:-25 to +85°C)	The capacitance measurement shall be made at each step in table. •Pretreatment for B,E char. Perform the heat treatment at 150+0/-10 °C for 60±5 min and then let sit for 24±2 h at *room condition. <table border="1" style="margin-left: auto; margin-right: auto;"> <thead> <tr> <th>Step</th> <th>1</th> <th>2</th> <th>3</th> <th>4</th> <th>5</th> </tr> </thead> <tbody> <tr> <td>Temp. (°C)</td> <td>20±2</td> <td>-25±2</td> <td>20±2</td> <td>85±2</td> <td>20±2</td> </tr> </tbody> </table>	Step	1	2	3	4	5	Temp. (°C)	20±2	-25±2	20±2	85±2	20±2
Step	1	2	3	4	5										
Temp. (°C)	20±2	-25±2	20±2	85±2	20±2										
9	Vibration resistance	Appearance	No marked defect.	Solder the capacitor to the Test Jig A (glass epoxy board) shown in "Complement of test method". The capacitor shall be subjected to a simple harmonic motion having a total amplitude of 1.5mm, the frequency being varied uniformly between the approximate limits of 10 and 55Hz. The frequency range, from 10 to 55Hz and return to 10Hz, shall be traversed in approximately 1 min. This motion shall be applied for a period of 2 h in each of 3 mutually perpendicular directions (total of 6h).											
		Capacitance	Within the specified tolerance.												
		D.F.	Pass the item No.7.												
10	Solderability of termination	75% of the terminations are to be soldered .	Immerse the capacitor in the solution of ethanol (JIS K 8101) and rosin (JIS K 5902) (25% rosin in weight proportion). Immerse in solder solution for 2±0.5s. Temp. of solder : 245±5°C												
11	Soldering effect (Reflow)	Appearance	No marked defects.	Preheat the capacitor at 150 to 180°C for 90±30s. Reflow temp. : 230°C min. (Max. temp. : 260°C) Reflow time : 30±10s. Reflow number of times : 4 times Let sit at *room condition for 24±2 h, then measure. • The next reflow process should be done after the temperature of the sample has dropped to room temperature. • Pretreatment for B,E char. Capacitor should be stored at 150+0/-10°C for 1 h, and apply the AC4000V(r.m.s.) 60s then placed at *room condition for 24±2 h before initial measurements.											
		Capacitance	Within ±10%												
		I.R.	1000 MΩ or more												
		Dielectric strength	Pass the item No.4.												
12	Adhesive strength of termination	No removal of the terminations or other defects should occur.	Solder the capacitor to the Test Jig A (glass epoxy board) shown in "Complement of Test method". Then apply 10N force in the direction of the arrow. 												

* "room condition" Temperature:15 to 35°C, Relative humidity:45 to 75%, Atmosphere pressure:86 to 106kPa

■ Specification and test methods

No.	Item	Specification	Test method															
13	Temperature cycle	Appearance	No marked defect.															
		Capacitance change	Within $\pm 15\%$															
		D.F.	SL :0.025 max. B,E:0.05 max.															
		I.R.	3000 M Ω or more															
		Dielectric strength	Pass the item No.4.															
<p>Fix the capacitor to the supporting Test Jig A (glass epoxy board) shown in "Complement of test method".</p> <p>Perform the 5 cycles according to the 4 heat treatments listed the following table.</p> <table border="1"> <thead> <tr> <th>Step</th> <th>Templ(°C)</th> <th>Time(min.)</th> </tr> </thead> <tbody> <tr> <td>1</td> <td>-40\pm3</td> <td>30\pm3</td> </tr> <tr> <td>2</td> <td>Room Temp.</td> <td>2 to 3</td> </tr> <tr> <td>3</td> <td>125\pm3</td> <td>30\pm3</td> </tr> <tr> <td>4</td> <td>Room Temp.</td> <td>2 to 3</td> </tr> </tbody> </table> <p>Let sit for 24\pm2 h at *room condition, then measure.</p> <p>•Pretreatment for B,E char. Capacitor should be stored at 150+0/-10°C for 1 h, and apply the AC4000V(r.m.s.) 60s then placed at *room condition for 24\pm2 h before initial measurements.</p>				Step	Templ(°C)	Time(min.)	1	-40 \pm 3	30 \pm 3	2	Room Temp.	2 to 3	3	125 \pm 3	30 \pm 3	4	Room Temp.	2 to 3
Step	Templ(°C)	Time(min.)																
1	-40 \pm 3	30 \pm 3																
2	Room Temp.	2 to 3																
3	125 \pm 3	30 \pm 3																
4	Room Temp.	2 to 3																
14	Humidity (Steady state)	Appearance	No marked defect.															
		Capacitance change	Within $\pm 20\%$															
		D.F.	SL :0.025 max. B,E:0.05 max.															
		I.R.	3000 M Ω or more															
		Dielectric strength	Pass the item No.4.															
<p>Sit the capacitor at 40\pm2°C and relative humidity 90 to 95% for 500+24/-0 h. Remove and let sit for 24\pm2 h at *room condition, then measure.</p> <p>• Pretreatment for B,E char. Capacitor should be stored at 150+0/-10°C for 1 h, and apply the AC4000V(r.m.s.) 60s then placed at *room condition for 24\pm2 h before initial measurements.</p>																		
15	Humidity Loading	Appearance	No marked defect.															
		Capacitance change	Within $\pm 20\%$															
		D.F.	SL :0.025 max. B,E:0.05 max.															
		I.R.	3000 M Ω or more															
		Dielectric strength	Pass the item No.4.															
<p>Apply the rated voltage at 40\pm2°C and relative humidity 90 to 95% for 500+24/-0 h. Remove and let sit for 24\pm2 h at *room condition, then measure.</p> <p>• Pretreatment for B,E char. Capacitor should be stored at 150+0/-10°C for 1 h, and apply the AC4000V(r.m.s.) 60s then placed at *room condition for 24\pm2 h before initial measurements.</p>																		
16	Life	Appearance	No marked defect.															
		Capacitance change	Within $\pm 20\%$															
		I.R.	3000 M Ω or more															
		Dielectric strength	Pass the item No.4.															
			<p>Impulse Voltage test is performed.</p> <p>Each individual capacitor shall be subjected to a 8kV Impulse (the voltage value means zero to peak) for 3 times.</p> <p>Then the capacitors are applied to life test.</p> <p>Front time (T1) = 1.7μs=1.67T Time to half-value (T2) = 50μs</p> <p>Apply voltage as Table for 1000 h at 125+2/-0°C, relative humidity 50% max.</p> <table border="1"> <thead> <tr> <th>Applied voltage</th> </tr> </thead> <tbody> <tr> <td>AC550V(r.m.s.), except that once each hour the voltage is increased to AC1000V(r.m.s.) for 0.1s.</td> </tr> </tbody> </table> <p>Remove and let sit for 24\pm2 h at *room condition, then measure.</p> <p>• Pretreatment for B,E char. Capacitor should be stored at 150+0/-10°C for 1 h, and apply the AC4000V(r.m.s.) 60s then placed at *room condition for 24\pm2 h before initial measurements.</p>	Applied voltage	AC550V(r.m.s.), except that once each hour the voltage is increased to AC1000V(r.m.s.) for 0.1s.													
Applied voltage																		
AC550V(r.m.s.), except that once each hour the voltage is increased to AC1000V(r.m.s.) for 0.1s.																		

* "room condition" Temperature:15 to 35°C, Relative humidity:45 to 75%, Atmosphere pressure:86 to 106kPa

■ Specification and test methods

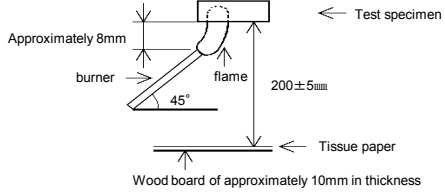
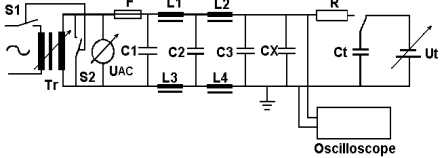
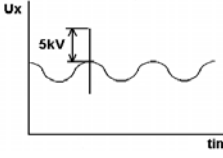
No.	Item	Specification	Test method
17	Passive flammability	The burning time should not be exceeded the time 30s. The tissue paper should not ignite.	The capacitor under test shall be held in the flame in the position which best promotes burning. Each specimen shall only be exposed once to the flame. Time of exposure to flame : 30 s. Length of flame : 12±1mm Gas burner : Length 35mm min. : Inside dia : 0.5±0.1mm : Outside dia : 0.9mm max. Gas : Butane gas purity 95% min. 
18	Active flammability	The cheese-cloth should not be on fire.	The capacitor shall be individually wrapped in at least one but more than two complete layers of cheesecloth. The capacitor shall be subjected to 20 discharges. The interval between successive discharges shall be 5 s. The UAC shall be maintained for 2 min after the last discharge.  C1,2 : 1μF±10%, C3 : 0.033μF±5% 10kV L1~4 : 1.5mH±20% 16A Rod core choke R : 100Ω±2%, Ct : 3mF±5% 10kV UAC : UR±5%, UR : Rated Voltage F : Fuse, rated 16A Cx : Capacitor specimens Ut : Voltage impressed on the tank capacitor Ct 

* "room condition" Temperature:15 to 35°C, Relative humidity:45 to 75%, Atmosphere pressure:86 to 106kPa

6. Complement of Test Method

6.1. Test Jig

The test jig should be Jig A as described in "Specifications and Test methods".

The specimen should be soldered by the conditions as described below.

Soldering Method : Reflow soldering

Solder : Sn-3.0Ag-0.5Cu

(1) Test Jig A

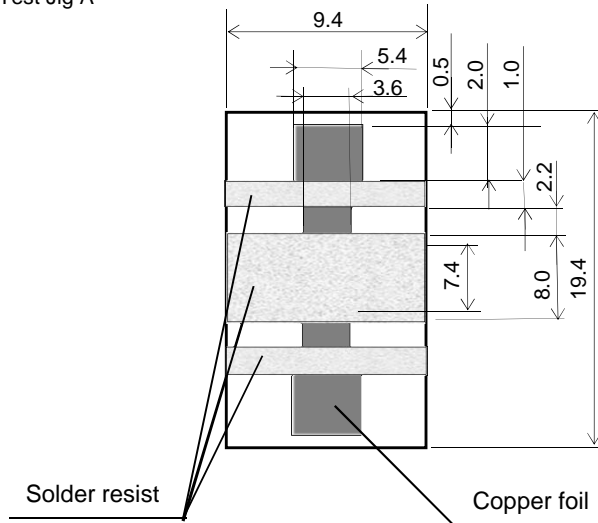

- Material : Glass Epoxy Board
- Thickness : 1.6mm
- Thickness of copper foil : 0.035mm

7. Packing

7.1. Dimension of tape

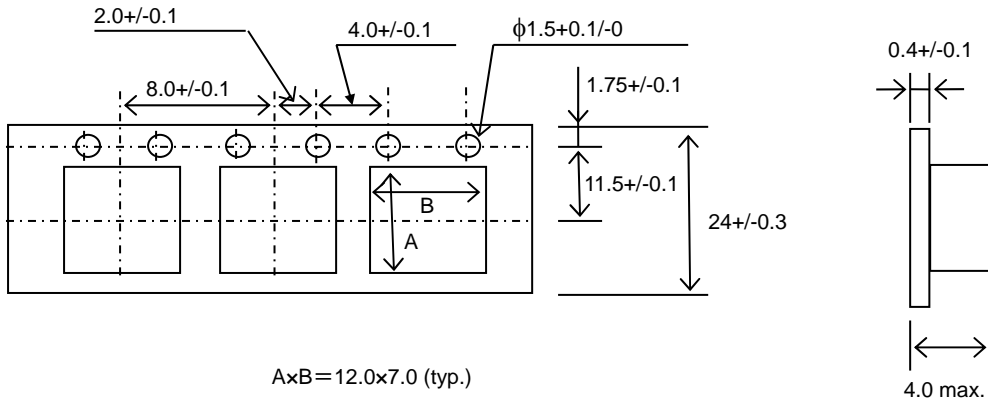

7.2. Dimension of Reel

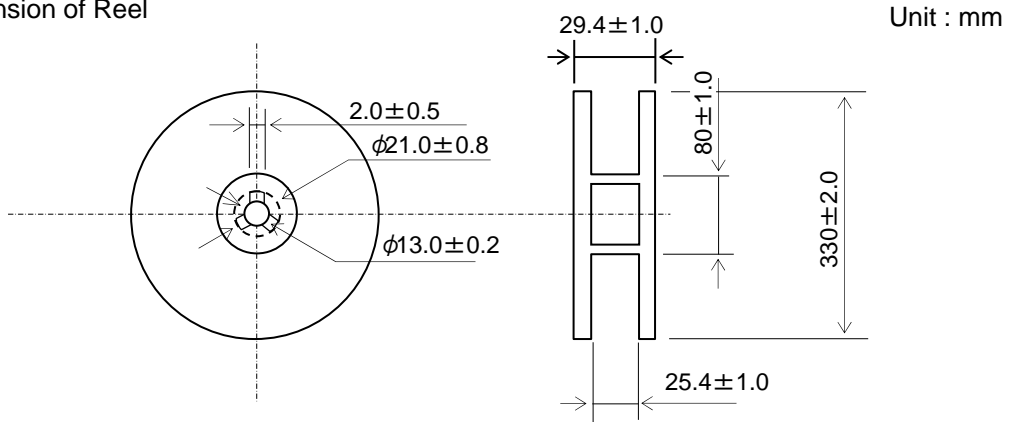

(1) Part of the leader and part of the empty tape shall be attached to the end of the tape as follows.

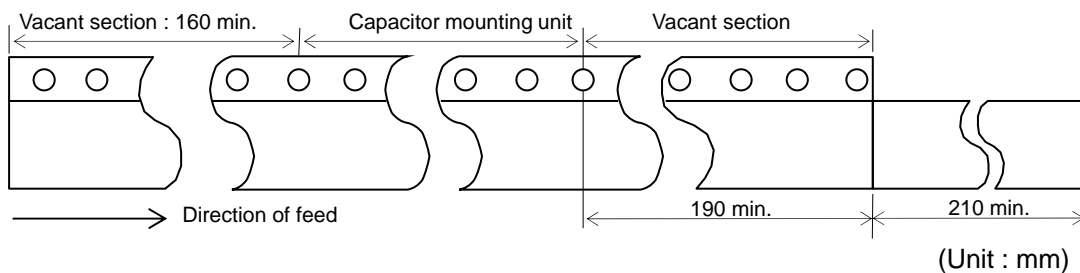

- (2) The top tape or cover tape and base tape are not attached at the end of the tape for a minimum of 2 pitches.
- (3) Missing capacitors number within 0.1% of the number per reel or 1pc, whichever is greater, and not continuous
- (4) The top tape or cover tape and bottom tape shall not protrude beyond the edges of the tape and shall not cover sprocket holes.
- (5) Cumulative tolerance of sprocket holes, 10 pitches : ± 0.3 mm.
- (6) Peeling off force : 0.1 to 0.6N in the direction shown on the follows.

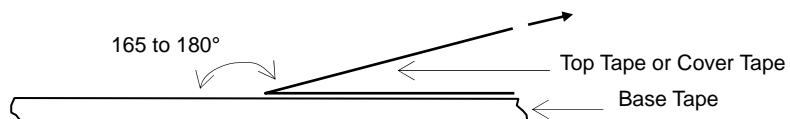

单击下面可查看定价，库存，交付和生命周期等信息

[>>Murata\(村田\)](#)