

Ceramic Trimmer Capacitors



muRata

*Innovator
in Electronics*

Murata
Manufacturing Co., Ltd.

Cat.No.T13E-15

EU RoHS Compliant

- All the products in this catalog comply with EU RoHS.
- EU RoHS is "the European Directive 2011/65/EU on the Restriction of the Use of Certain Hazardous Substances in Electrical and Electronic Equipment."
- For more details, please refer to our website 'Murata's Approach for EU RoHS' (<http://www.murata.com/info/rohs.html>).

CONTENTS

1

Part Numbering	2
Selection Guide of Ceramic Trimmer Capacitors	3
1 TZR1 Series	4
2 TZS2 Series	8
3 TZY2 Series	12
4 TZV2 Series	16
5 TZC3 Series	20
6 TZW4 Series	24
7 TZB4 Series	27
Packaging	32
Recommended Adjustment Tools	34
Qualified Standards	36

2

3

4

5

6

7

Bluetooth® is a registered trademark or trademark of Bluetooth SIG, Inc. in the United States and other countries.

● Part Numbering

Ceramic Trimmer Capacitors

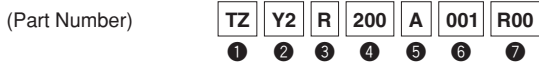

① Product ID

Product ID	
TZ	Trimmer Capacitors

② Series/Terminal

Code	Series/Terminal
B4	4mm Size SMD Type
W4	4mm Size SMD Type
C3	3mm Size SMD Type
S2	2mm Size SMD Type (Height 1.0mm)
Y2	2mm Size SMD Type (Height 1.25mm)
V2	2mm Size SMD Type (Height 1.45mm)
R1	1mm Size SMD Type (Height 0.90mm)

③ Temperature Characteristics

Code	Temperature Characteristics
Z	NP0ppm/°C
R	N750ppm/°C
K	N1000ppm/°C
P	N1200ppm/°C

Please refer to ratings for tolerance of temperature characteristics.

④ Maximum Capacitance

Expressed by three-digit alphanumerics. The unit is pico-farad (pF). The first and second figures are significant digits, and the third figure expresses the number of zeros that follow the two numbers. If there is a decimal point, it is expressed by the capital letter "R". In this case, all figures are significant digits.

⑤ Terminal Shape

Code	Terminal Shape
A	Top Adjustment: TZR1, TZS2, TZY2, TZV2, TZC3, TZW4, TZB4
B	Top Adjustment: TZB4

Please refer to dimensions for terminal details.

⑥ Individual Specifications

Code	Individual Specifications
001	TZR1, TZS2, TZY2, TZW4 Standard Type
110	TZV2, TZC3 Standard Type
A10	TZB4 No-cover Film Standard Type
B10	TZB4 with Cover Film Standard Type

⑦ Packaging











Code	Packaging
B00	Bulk
R00	Reel (Taping ø180mm)
R01*	Reel (Taping ø330mm)

* TZB4 only.

Selection Guide of Ceramic Trimmer Capacitors

Mounting Method?

Surface Mount

Reflow		High Frequency Power	Flow
<p>Height 0.90mm max.</p> <p> TZR1 1.5(W) x 1.7(L)</p>	<p>Height 1.7mm max.</p> <p> TZC3 3.2(W) x 4.5(L)</p>	<p>Height 2.6mm max.</p> <p> TZW4 4.2(W) x 5.2(L)</p>	<p>Height 3.2mm max.</p> <p> TZB4_A 4.0(W) x 4.5(L) (with cover film)</p>
<p>Height 1.00mm max.</p> <p> TZS2 2.2(W) x 2.7(L)</p>	<p>Height 3.2mm max.</p> <p> TZB4_A 4.0(W) x 4.5(L)</p>		<p> TZB4_B 4.0(W) x 4.5(L) (with cover film)</p>
<p>Height 1.25mm max.</p> <p> TZY2 2.5(W) x 3.2(L)</p>	<p> TZB4_B 4.0(W) x 4.5(L)</p>		
<p>Height 1.45mm max.</p> <p> TZV2 2.3(W) x 3.2(L)</p>			

All Ceramic Trimmer Capacitor products comply with RoHS and ELV.

Ceramic Trimmer Capacitors



TZR1 Series

■ Features

1. Ultra-small and thin with external dimensions of 1.5(W)x1.7(L)x0.85(H)mm (80% less in volume than the current product).
2. Unique construction with no plastic material provides superior soldering heat resistance to maintain excellent characteristic performance after reflow soldering.
3. Suitable for high frequency circuit due to high self-resonant frequency (6.2GHz of TZR1Z010 at 1.0pF setting).

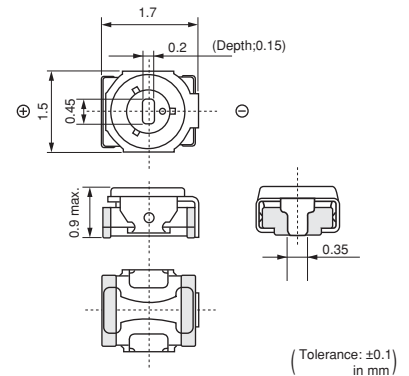

■ Applications

1. Bluetooth®
2. Crystal oscillators
3. Crystal filters
4. Hand radios
5. Miniature tuner packs (FM Radio, TV)
6. Remote keyless entry systems
7. Pagers

Part Number	C min. (max.) (pF)	C max. (pF)	TC	Q	Rated Voltage	Withstanding Voltage
TZR1Z010A001	0.55	1.0 +100/-0%	NP0±300ppm/°C	200min. at 200MHz, Cmax.	25Vdc	55Vdc
TZR1Z1R5A001	0.7	1.5 +100/-0%	NP0±300ppm/°C	200min. at 200MHz, Cmax.	25Vdc	55Vdc
TZR1Z040A001	1.5	4.0 +100/-0%	NP0±500ppm/°C	300min. at 1MHz, Cmax.	25Vdc	55Vdc
TZR1R080A001	3.0	8.0 +100/-0%	N750±500ppm/°C	300min. at 1MHz, Cmax.	25Vdc	55Vdc

Insulation Resistance: 10000M ohm Torque: 0.1 to 1.0mNm Operating Temperature Range: -25 to +85°C

■ Construction

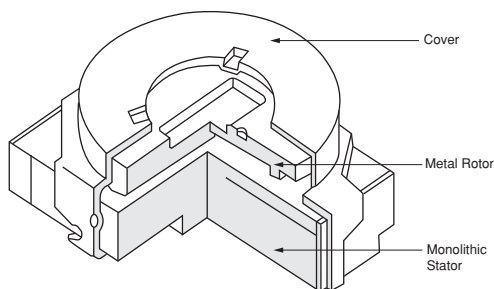

■ Temperature Characteristics

TZR1Z010

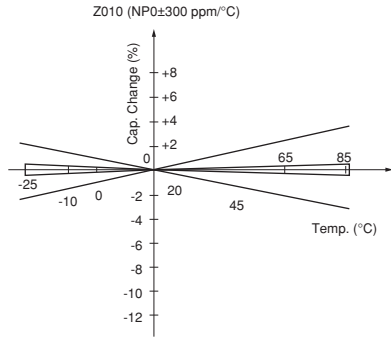

TZR1Z1R5

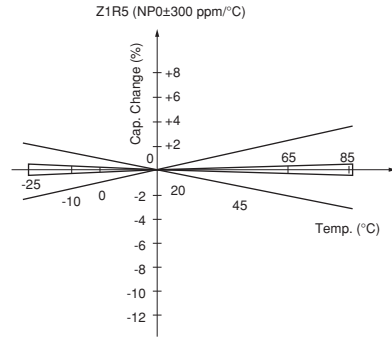

TZR1Z040

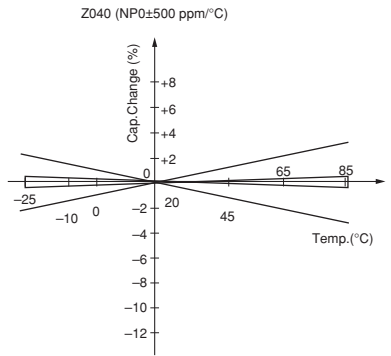

TZR1R080

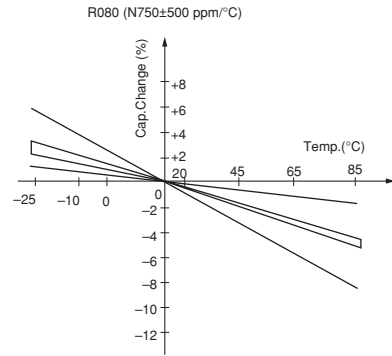

■ Frequency Characteristics

TZR1Z010

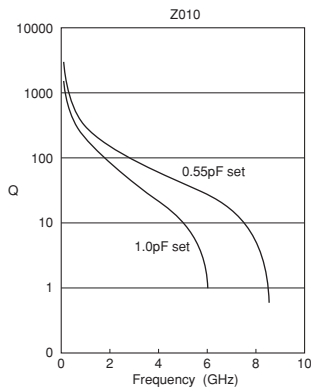

TZR1Z1R5

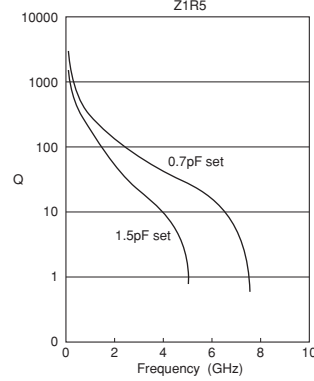

TZR1Z040

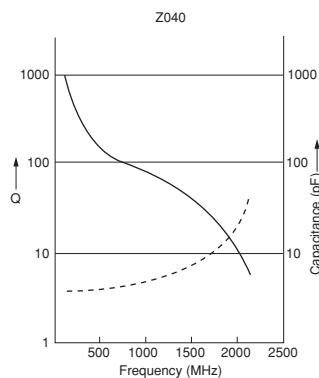

TZR1R080

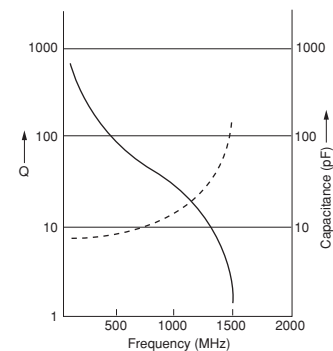

■ Land Pattern

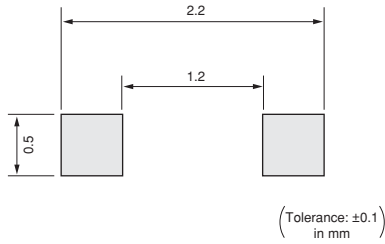

■ Temperature Profile

● Reflow Soldering Profile

① Soldering profile for Lead-free solder (96.5Sn/3Ag/0.5Cu)

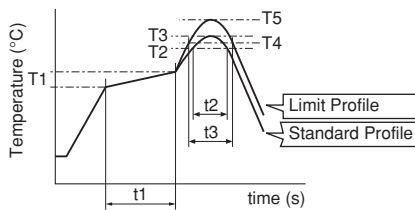

Standard Profile					
Pre-heating		Heating		Peak temperature (T3)	Cycle of reflow
Temp. (T1)	Time (t1)	Temp. (T2)	Time (t2)		
150 to 180°C	60 to 120sec.	220°C	30 to 60sec.	245±3°C	2 times

Limit Profile					
Pre-heating		Heating		Peak temperature (T5)	Cycle of reflow
Temp. (T1)	Time (t1)	Temp. (T4)	Time (t3)		
150 to 180°C	60 to 120sec.	230°C	30 to 50sec.	260 +5/-0°C	2 times

② Soldering profile for Eutectic solder (63Sn/37Pb)

(Limit profile: refer to ①)

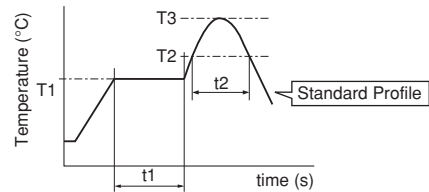

Standard Profile					
Pre-heating		Heating		Peak temperature (T3)	Cycle of reflow
Temp. (T1)	Time (t1)	Temp. (T2)	Time (t2)		
150°C	60 to 120sec.	183°C	30sec.	230 +5/-0°C	1 time

● Soldering Iron

Standard Profile			
Temperature of soldering iron tip	Soldering time	Soldering iron power output	Cycle of soldering iron
350±10°C	3sec. max.	30W max.	1 time

■ Notice (Storage and Operating Conditions)

- Do not use the trimmer capacitor under atmosphere of RTV silicone rubber (Room Temperature Vulcanizing Silicone Rubber) except Acetone liberating silicone sealant.
- Before using trimmer capacitors, please store under the conditions of -10 to +40°C and 30 to 85%RH.
- Do not store in or near corrosive gasses.
- Use within 6 months of delivery.
- Do not store under direct sunlight.
- Do not use the trimmer capacitor under the conditions listed below.
 - Corrosive gasses atmosphere (ex. Chlorine gas, Hydrogen sulfide gas, Ammonia gas, Sulfuric acid gas, Nitric oxide gas, etc.)
 - In liquid (ex. water, oil, medical liquid, organic solvent, etc.)
 - Dusty / dirty atmosphere
 - Direct sunlight
 - Static voltage or electric/magnetic fields
 - Direct sea breeze
 - Other variations of the above

■ Notice (Soldering and Mounting)

1. Soldering

- (1) TZR1 series can be soldered by reflow soldering method and soldering iron. Do not use flow soldering method (dipping).
- (2) Soldering conditions
Refer to the temperature profile.
If the soldering conditions are not suitable, e.g., excessive time and/or excessive temperature, the trimmer capacitor may deviate from the specified characteristics.
- (3) The amount of solder is critical.
- (4) The thickness of solder paste should be printed from 100 micro m to 150 micro m and the dimension of land pattern should be Murata's standard land pattern used at reflow soldering.
Insufficient amounts of solder can lead to insufficient soldering strength on PCB.
Excessive amounts of solder may cause bridging between the terminals or contact failure due to flux wicking up.
- (5) When using soldering iron, the diameter of the string solder shall be less than 0.5mm. The string solder shall be applied to the lower part of the terminal only. Do not apply flux except to the terminals. Excessive amounts of solder and/or applying solder to the upper part of the terminal may cause fixed metal rotor or contact failure due to flux invasion into the movable part and/or the contact point. The soldering iron should not come in contact with the monolithic stator of the trimmer capacitor. If such contact does occur, the trimmer capacitor may be damaged.

- (6) Our recommended chlorine content of solder is as follows.
 - (a) Solder paste: 0.2wt% max.
 - (b) String solder: 0.5wt% max.
- (7) Do not use water-soluble flux (for water cleaning). To prevent the deterioration of trimmer capacitor characteristics, apply flux only to terminals.

2. Mounting

- (1) Do not apply excessive force (preferably 5.0 N [Ref: 500gf] max.), when the trimmer capacitor is mounted on the PCB.
- (2) Do not warp and/or bend PCB to protect trimmer capacitor from breaking.
- (3) Use a pick-up nozzle of a suitable dimension. (1.6mm external diameter and 0.8mm bore diameter.)

3. Cleaning

This product cannot be cleaned because of open construction.

4. Other

Note the polarity of the trimmer capacitor to minimize influence by stray capacitance. (Refer to the dimensions concerning the polarity.)

■ Notice (Handling)

1. Use suitable screwdrivers that fit comfortably in driver slot.
*Recommended screwdriver for manual adjustment
MURATA: KMDR160
2. When adjusting with a screwdriver, do not apply excessive force (preferably 0.5 N [Ref: 50gf] max.) to minimize capacitance drift. Excessive force applied to the screwdriver slot may cause deformation of the products.

3. Do not apply adhesive, lock paints, or any other substances to the trimmer capacitor to secure the rotor position. They may cause corrosion or electrical contact problems.

■ Notice (Other)

Before using trimmer capacitors, please test after assembly in your particular mass production system.

Ceramic Trimmer Capacitors



TZS2 Series

2

■ Features

1. Ultra-small and thin type with external dimensions of 2.2(W)x2.7(L)x0.95(H)mm (30% less in volume than the current product).
2. Unique construction with no plastic material provides superior soldering heat resistance to maintain excellent characteristic performance after reflow soldering.
3. Pierced square hole allows for high resistance to tuning force and in-process automatic adjustment.

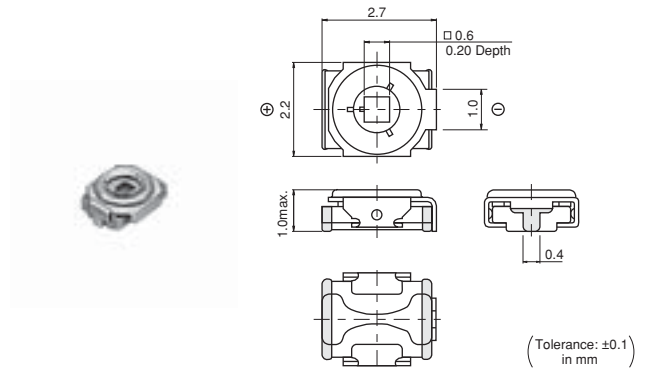

■ Applications

- | | |
|------------------------|---------------------------------|
| 1. Crystal oscillators | 8. Remote keyless entry systems |
| 2. Crystal filters | 9. PHS |
| 3. Hand radios | 10. Radar detectors |
| 4. Cordless telephones | 11. W-LAN |
| 5. Cellular telephones | 12. Compact radios |
| 6. Tuner packs | 13. Headphone stereos |
| 7. Pagers | |

Part Number	C min. (max.) (pF)	C max. (pF)	TC	Q	Rated Voltage	Withstanding Voltage
TZS2Z060A001	3.0	6.0 +100/-0%	NP0±300ppm/°C	500min. at 1MHz, Cmax.	25Vdc	55Vdc
TZS2Z100A001	3.5	10.0 +100/-0%	NP0±300ppm/°C	500min. at 1MHz, Cmax.	25Vdc	55Vdc
TZS2R200A001	7.0	20.0 +100/-0%	N750±500ppm/°C	500min. at 1MHz, Cmax.	25Vdc	55Vdc

Insulation Resistance: 10000M ohm Torque: 0.7 to 4.9mNm Operating Temperature Range: -25 to +85°C

■ Construction

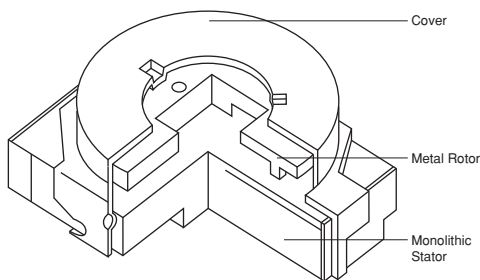

Temperature Characteristics

TZS2Z060

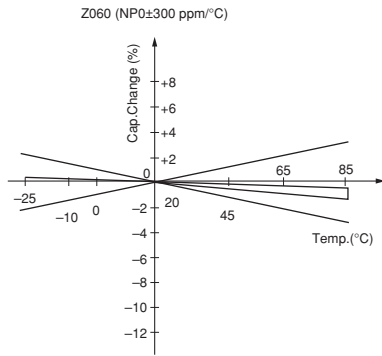

TZS2Z100

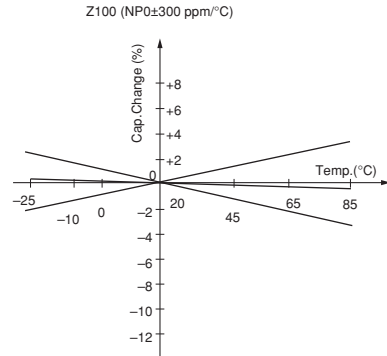

TZS2R200

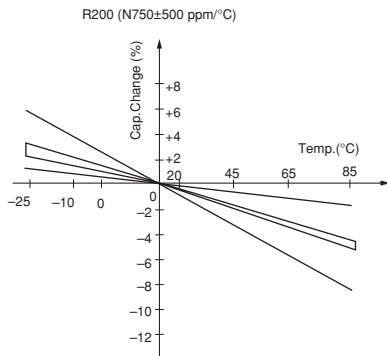

Frequency Characteristics

TZS2Z060

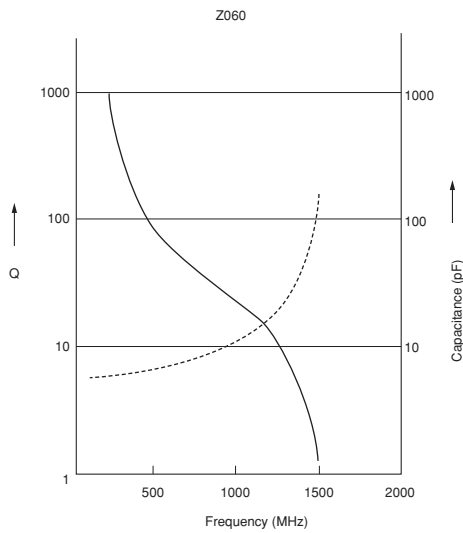

TZS2Z100

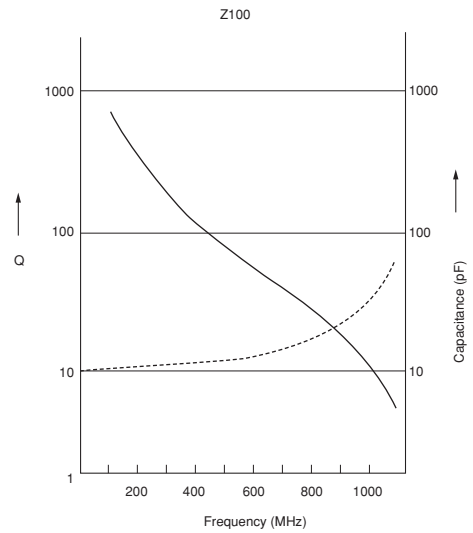

Continued on the following page. ↗

Continued from the preceding page.

Frequency Characteristics

TZS2R200

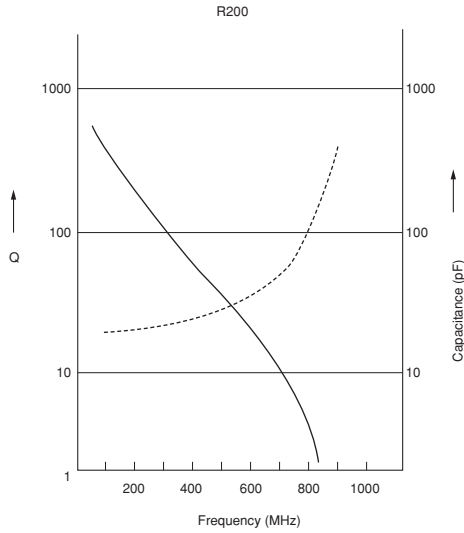

Land Pattern

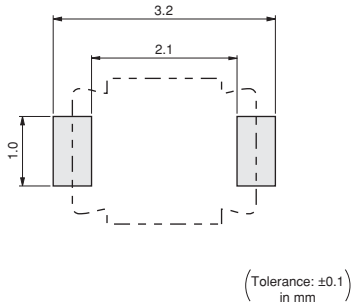

Temperature Profile

Reflow Soldering Profile

① Soldering profile for Lead-free solder (96.5Sn/3Ag/0.5Cu)

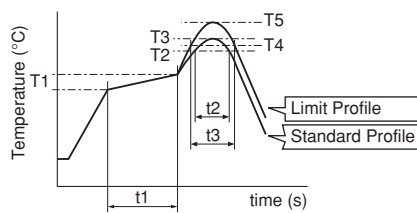

Standard Profile					
Pre-heating		Heating		Peak temperature (T3)	Cycle of reflow
Temp. (T1)	Time (t1)	Temp. (T2)	Time (t2)		
150 to 180°C	60 to 120sec.	220°C	30 to 60sec.	245±3°C	2 times

Limit Profile					
Pre-heating		Heating		Peak temperature (T5)	Cycle of reflow
Temp. (T1)	Time (t1)	Temp. (T4)	Time (t3)		
150 to 180°C	60 to 120sec.	230°C	30 to 50sec.	260 +5/-0°C	2 times

② Soldering profile for Eutectic solder (63Sn/37Pb)

(Limit profile: refer to ①)

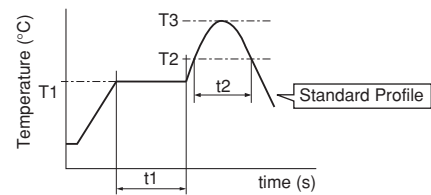

Standard Profile					
Pre-heating		Heating		Peak temperature (T3)	Cycle of reflow
Temp. (T1)	Time (t1)	Temp. (T2)	Time (t2)		
150°C	60 to 120sec.	183°C	30sec.	230 +5/-0°C	1 time

Soldering Iron

Standard Profile			
Temperature of soldering iron tip	Soldering time	Soldering iron power output	Cycle of soldering iron
350±10°C	3sec. max.	30W max.	1 time

■ Notice (Storage and Operating Conditions)

1. Do not use the trimmer capacitor under atmosphere of RTV silicone rubber (Room Temperature Vulcanizing Silicone Rubber) except Acetone liberating silicone sealant.
2. Before using trimmer capacitors, please store under the conditions of -10 to +40°C and 30 to 85%RH.
3. Do not store in or near corrosive gasses.
4. Use within 6 months of delivery.
5. Do not store under direct sunlight.

■ Notice (Soldering and Mounting)

1. Soldering
 - (1) TZS2 series can be soldered by reflow soldering method and soldering iron. Do not use flow soldering method (dipping).
 - (2) Soldering conditions
Refer to the temperature profile.
If the soldering conditions are not suitable, e.g., excessive time and/or excessive temperature, the trimmer capacitor may deviate from the specified characteristics.
 - (3) The amount of solder is critical.
 - (4) The thickness of solder paste should be printed from 100 micro m to 150 micro m and the dimension of land pattern should be Murata's standard land pattern used at reflow soldering.
Insufficient amounts of solder can lead to insufficient soldering strength on PCB.
Excessive amounts of solder may cause bridging between the terminals or contact failure due to flux wicking up.
 - (5) When using soldering iron, the diameter of the string solder shall be less than 0.5mm. The string solder shall be applied to the lower part of the terminal only. Do not apply flux except to the terminals. Excessive amounts of solder and/or applying solder to the upper part of the terminal may cause fixed metal rotor or contact failure due to flux invasion into the movable

■ Notice (Handling)

1. Use suitable screwdrivers that fit comfortably in driver slot.
 - (1) Recommended screwdriver for manual adjustment
MURATA: KMDR050
 - (2) Recommended screwdriver bit for automatic adjustment
MURATA: KMBT050

■ Notice (Other)

Before using trimmer capacitors, please test after assembly in your particular mass production system.

6. Do not use the trimmer capacitor under the conditions listed below.
 - (1) Corrosive gasses atmosphere
(ex. Chlorine gas, Hydrogen sulfide gas, Ammonia gas, Sulfuric acid gas, Nitric oxide gas, etc.)
 - (2) In liquid (ex. water, oil, medical liquid, organic solvent, etc.)
 - (3) Dusty / dirty atmosphere
 - (4) Direct sunlight
 - (5) Static voltage or electric/magnetic fields
 - (6) Direct sea breeze
 - (7) Other variations of the above

part and/or the contact point. The soldering iron should not come in contact with the monolithic stator of the trimmer capacitor.

If such contact does occur, the trimmer capacitor may be damaged.

- (6) Our recommended chlorine content of solder is as follows.
 - (a) Solder paste: 0.2wt% max.
 - (b) String solder: 0.5wt% max.
 - (7) Do not use water-soluble flux (for water cleaning). To prevent the deterioration of trimmer capacitor characteristics, apply flux only to terminals.
2. Mounting
 - (1) Do not apply excessive force (preferably 5.0 N [Ref: 500gf] max.), when the trimmer capacitor is mounted on the PCB.
 - (2) Do not warp and/or bend PCB to protect trimmer capacitor from breakage.
 - (3) Use a pick-up nozzle of a suitable dimension.
(2.0mm external diameter and 1.0mm bore diameter.)
 3. Cleaning
This product cannot be cleaned because of open construction.
 4. Other
Note the polarity of the trimmer capacitor to minimize influence by stray capacitance.
(Refer to the dimensions concerning the polarity.)

2. When adjusting with a screwdriver, do not apply excessive force (preferably 1.0 N [Ref: 100gf] max.) to minimize capacitance drift. Excessive force applied to the screwdriver slot may cause deformation of the products.
3. Do not apply adhesive, lock paints, or any other substances to the trimmer capacitor to secure the rotor position. They may cause corrosion or electrical contact problems.

Ceramic Trimmer Capacitors



TZY2 Series

3

■ Features

1. Small and thin size with external dimensions of 2.5(W)x3.2(L)x1.25max.(H)mm.
2. New shape of cover can improve the flux invasion compared with current products.
3. Improvement of the adhesion between rotor and stator leads to superior stability.
4. Unique construction with no plastic material provides superior soldering heat resistance to maintain excellent characteristic performance after reflow soldering.
5. Suitable for high frequency circuit due to high self-resonant frequency (4.8GHz of TZY2Z010 at 1.0pF setting).

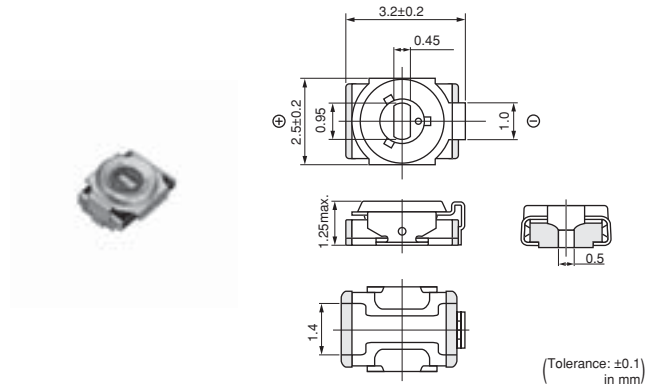

■ Applications

- | | |
|------------------------|---------------------------------|
| 1. Crystal oscillators | 9. Remote keyless entry systems |
| 2. Crystal filters | 10. W-LAN |
| 3. Pagers | 11. Radar detectors |
| 4. Cordless telephones | 12. Compact radios |
| 5. PHS | 13. DVD |
| 6. Hand radios | 14. Burglarproof devices |
| 7. Cellular telephones | 15. Headphone stereos |
| 8. Watches | |

Part Number	C min. (max.) (pF)	C max. (pF)	TC	Q	Rated Voltage	Withstanding Voltage
TZY2Z010A001	0.5	1.0 +100/-0%	NP0±300ppm/°C	200min. at 200MHz, Cmax.	25Vdc	55Vdc
TZY2Z2R5A001	0.65	2.5 +100/-0%	NP0±300ppm/°C	200min. at 200MHz, Cmax.	25Vdc	55Vdc
TZY2Z030A001	1.5	3.0 +100/-0%	NP0±300ppm/°C	300min. at 1MHz, Cmax.	25Vdc	55Vdc
TZY2Z060A001	2.5	6.0 +100/-0%	NP0±300ppm/°C	500min. at 1MHz, Cmax.	25Vdc	55Vdc
TZY2Z100A001	3.0	10.0 +100/-0%	NP0±300ppm/°C	500min. at 1MHz, Cmax.	25Vdc	55Vdc
TZY2R200A001	4.5	20.0 +100/-0%	N750±500ppm/°C	500min. at 1MHz, Cmax.	25Vdc	55Vdc
TZY2R250A001	5.5	25.0 +100/-0%	N750±500ppm/°C	300min. at 1MHz, Cmax.	25Vdc	55Vdc
TZY2K450A001	8.0	45.0 +100/-0%	N1000±500ppm/°C	300min. at 1MHz, Cmax.	25Vdc	55Vdc

Insulation Resistance: 10000M ohm Torque: 0.7 to 4.9mNm Operating Temperature Range: -25 to +85°C

■ Construction

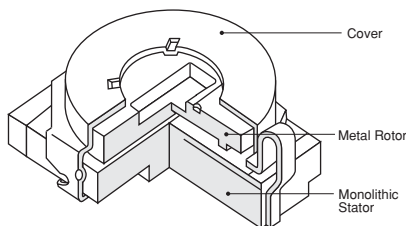

Temperature Characteristics

TZY2Z010

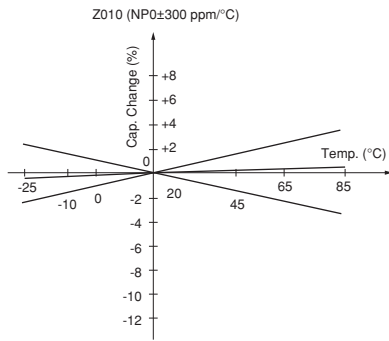

TZY2Z100

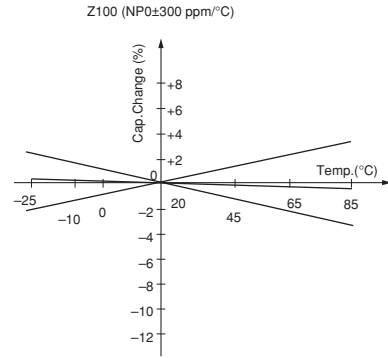

TZY2R200

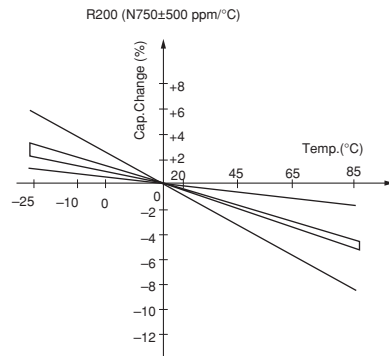

TZY2K450

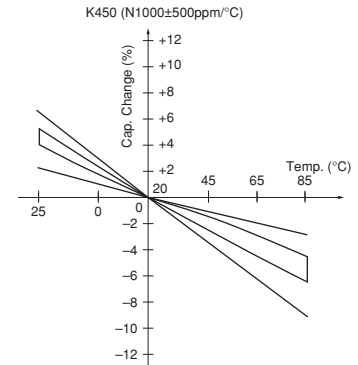

Frequency Characteristics

TZY2Z010

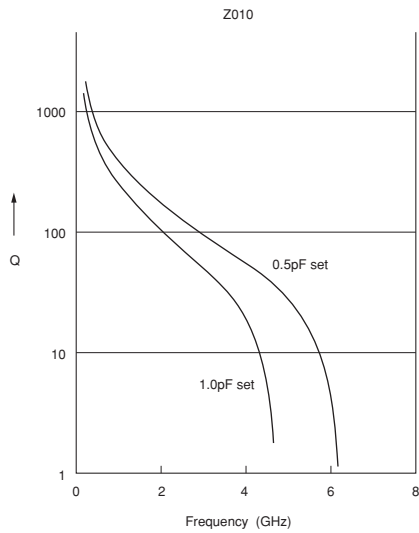

TZY2Z100

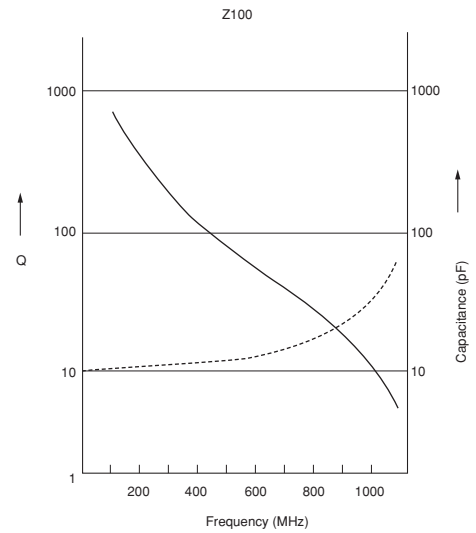

Continued on the following page.

Continued from the preceding page.

Frequency Characteristics

TZY2R200

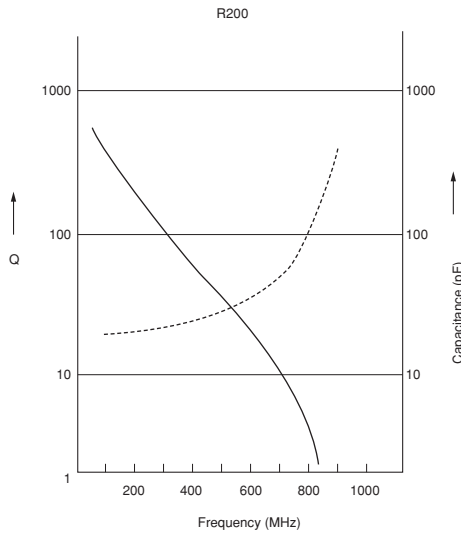

TZY2K450

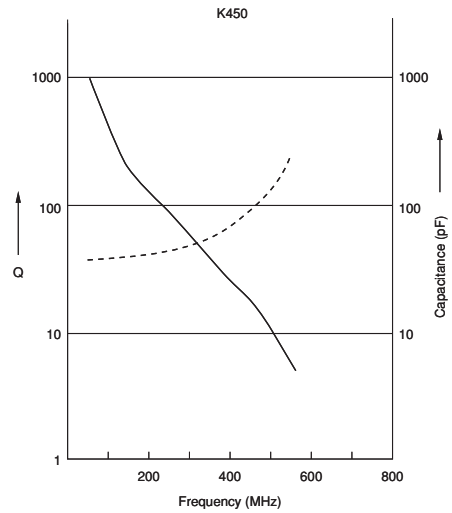

3

Land Pattern

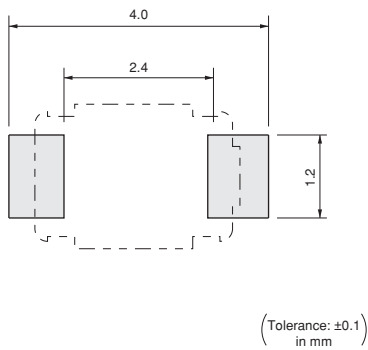

Temperature Profile

Reflow Soldering Profile

① Soldering profile for Lead-free solder (96.5Sn/3Ag/0.5Cu)

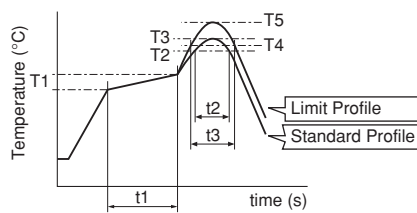

Standard Profile					
Pre-heating		Heating		Peak temperature (T3)	Cycle of reflow
Temp. (T1)	Time (t1)	Temp. (T2)	Time (t2)		
150 to 180°C	60 to 120sec.	220°C	30 to 60sec.	245±3°C	2 times

Limit Profile					
Pre-heating		Heating		Peak temperature (T5)	Cycle of reflow
Temp. (T1)	Time (t1)	Temp. (T4)	Time (t3)		
150 to 180°C	60 to 120sec.	230°C	30 to 50sec.	260 +5/-0°C	2 times

② Soldering profile for Eutectic solder (63Sn/37Pb)

(Limit profile: refer to ①)

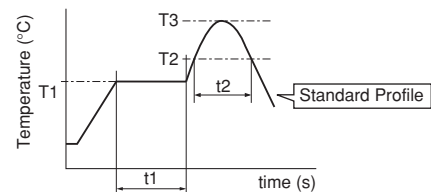

Standard Profile					
Pre-heating		Heating		Peak temperature (T3)	Cycle of reflow
Temp. (T1)	Time (t1)	Temp. (T2)	Time (t2)		
150°C	60 to 120sec.	183°C	30sec.	230 +5/-0°C	1 time

Soldering Iron

Standard Profile			
Temperature of soldering iron tip	Soldering time	Soldering iron power output	Cycle of soldering iron
350±10°C	3sec. max.	30W max.	1 time

■ Notice (Storage and Operating Conditions)

1. Do not use the trimmer capacitor under atmosphere of RTV silicone rubber (Room Temperature Vulcanizing Silicone Rubber) except Acetone liberating silicone sealant.
2. Before using trimmer capacitors, please store under the conditions of -10 to +40°C and 30 to 85%RH.
3. Do not store in or near corrosive gasses.
4. Use within 6 months of delivery.
5. Do not store under direct sunlight.

■ Notice (Soldering and Mounting)

1. Soldering
 - (1) TZY2 series can be soldered by reflow soldering method and soldering iron. Do not use flow soldering method (dipping).
 - (2) Soldering conditions
Refer to the temperature profile.
If the soldering conditions are not suitable, e.g., excessive time and/or excessive temperature, the trimmer capacitor may deviate from the specified characteristics.
 - (3) The amount of solder is critical.
 - (4) The thickness of solder paste should be printed from 120 micro m to 170 micro m and the dimension of land pattern should be Murata's standard land pattern used at reflow soldering.
Insufficient amounts of solder can lead to insufficient soldering strength on PCB.
Excessive amounts of solder may cause bridging between the terminals or contact failure due to flux wicking up.
 - (5) When using soldering iron, the diameter of the string solder shall be less than 0.5mm. The string solder shall be applied to the lower part of the terminal only. Do not apply flux except to the terminals. Excessive amounts of solder and/or applying solder to the upper part of the terminal may cause fixed metal rotor or contact failure due to flux invasion into

■ Notice (Handling)

1. Use suitable screwdrivers that fit comfortably in driver slot.
 - (1) Recommended screwdriver for manual adjustment
ENGINEER INC.: DA-89
(Murata P/N is KMDR060)
 - (2) Recommended screwdriver bit for automatic adjustment
MURATA: KMBT060

■ Notice (Other)

Before using trimmer capacitor, please test after assembly in your particular mass production system.

6. Do not use the trimmer capacitor under the conditions listed below.
 - (1) Corrosive gasses atmosphere
(ex. Chlorine gas, Hydrogen sulfide gas, Ammonia gas, Sulfuric acid gas, Nitric oxide gas, etc.)
 - (2) In liquid (ex. water, oil, medical liquid, organic solvent, etc.)
 - (3) Dusty / dirty atmosphere
 - (4) Direct sunlight
 - (5) Static voltage or electric/magnetic fields
 - (6) Direct sea breeze
 - (7) Other variations of the above

the movable part and/or the contact point. The soldering iron should not come in contact with the monolithic stator of the trimmer capacitor. If such contact does occur, the trimmer capacitor may be damaged.

- (6) Our recommended chlorine content of solder is as follows.
 - (a) Solder paste: 0.2wt% max.
 - (b) String solder: 0.5wt% max.
 - (7) Do not use water-soluble flux (for water cleaning). To prevent the deterioration of trimmer capacitor characteristics, apply flux only to terminals.
2. Mounting
 - (1) Do not apply excessive force (preferably 5.0 N [Ref: 500gf] max.), when the trimmer capacitor is mounted on the PCB.
 - (2) Do not warp and/or bend PCB to protect trimmer capacitor from breakage.
 - (3) Use a pick-up nozzle of a suitable dimension.
(2.5mm external diameter and 1.2mm bore diameter.)
 3. Cleaning
This product cannot be cleaned because of open construction.
 4. Other
Note the polarity of the trimmer capacitor to minimize influence by stray capacitance.
(Refer to the dimensions concerning the polarity.)

2. When adjusting with a screwdriver, do not apply excessive force (preferably 1.0 N [Ref: 100gf] max.) to minimize capacitance drift. Excessive force applied to the screwdriver slot may cause deformation of the products.
3. Do not apply adhesive, lock paints, or any other substances to the trimmer capacitor to secure the rotor position. They may cause corrosion or electrical contact problems.

Ceramic Trimmer Capacitors



TZV2 Series

■ Features

1. Small size with external dimensions of 2.3(W)x3.2(L)x1.45max.(H)mm.
2. Unique construction with no plastic material provides superior soldering heat resistance to maintain excellent characteristic performance after reflow soldering.
3. Designed for automatic placement in surface mount applications.
4. Funnel shaped metal case enables in-process automatic adjustment.

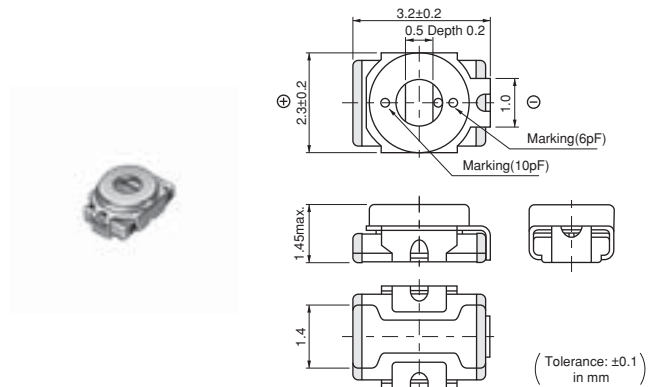

■ Applications

1. Crystal oscillator
2. Crystal filters
3. Hand radios
4. Cordless telephones
5. Cellular telephones
6. Tuner packs
7. Pagers
8. Remote keyless entry systems
9. PHS
10. Radar detectors
11. W-LAN
12. Compact radios
13. Headphone stereos
14. DVD
15. Burglarproof devices

Part Number	C min. (max.) (pF)	C max. (pF)	TC	Q	Rated Voltage	Withstanding Voltage
TZV2Z2R5A110	0.65	2.5 +100/-0%	NP0±300ppm/°C	200min. at 200MHz, Cmax.	25Vdc	55Vdc
TZV2Z030A110	1.5	3.0 +100/-0%	NP0±300ppm/°C	300min. at 1MHz, Cmax.	25Vdc	55Vdc
TZV2Z060A110	2.5	6.0 +100/-0%	NP0±300ppm/°C	500min. at 1MHz, Cmax.	25Vdc	55Vdc
TZV2Z100A110	3.0	10.0 +100/-0%	NP0±300ppm/°C	500min. at 1MHz, Cmax.	25Vdc	55Vdc
TZV2R200A110	4.5	20.0 +100/-0%	N750±500ppm/°C	500min. at 1MHz, Cmax.	25Vdc	55Vdc

Insulation Resistance: 10000M ohm Torque: 1.0 to 9.8mNm Operating Temperature Range: -25 to +85°C

■ Construction

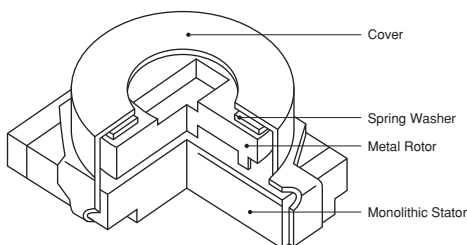

■ Temperature Characteristics

TZV2Z2R5

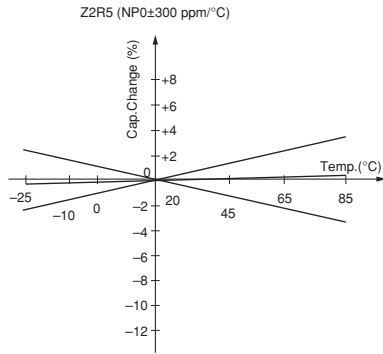

TZV2Z060

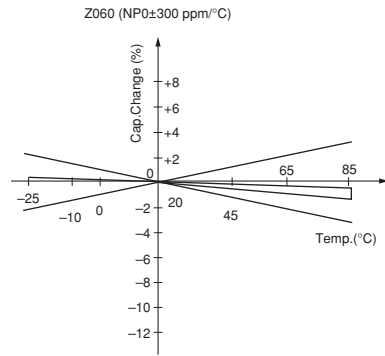

TZV2Z100

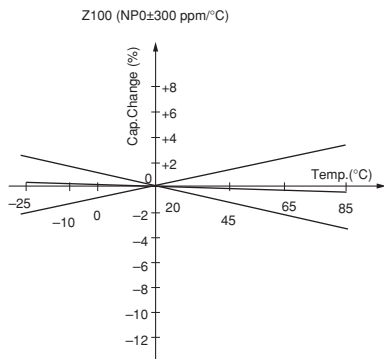

TZV2R200

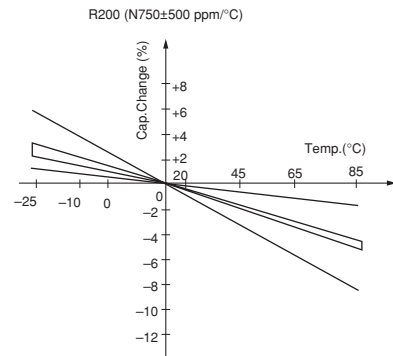

4

■ Frequency Characteristics

TZV2Z2R5

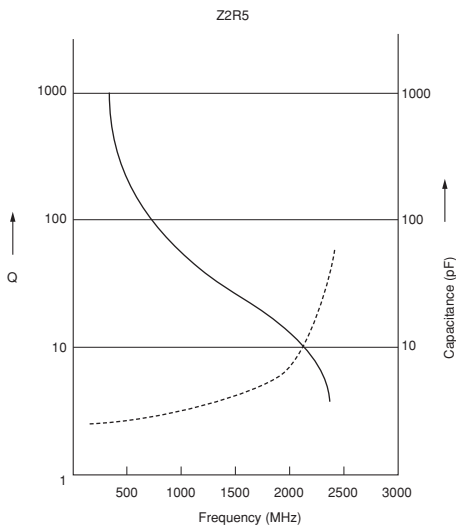

TZV2Z060

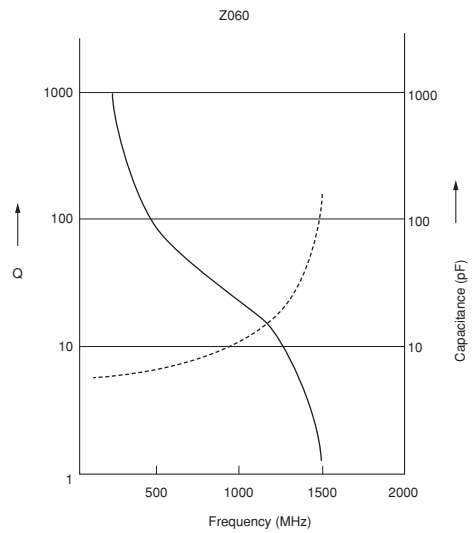

Continued on the following page.

Continued from the preceding page.

Frequency Characteristics

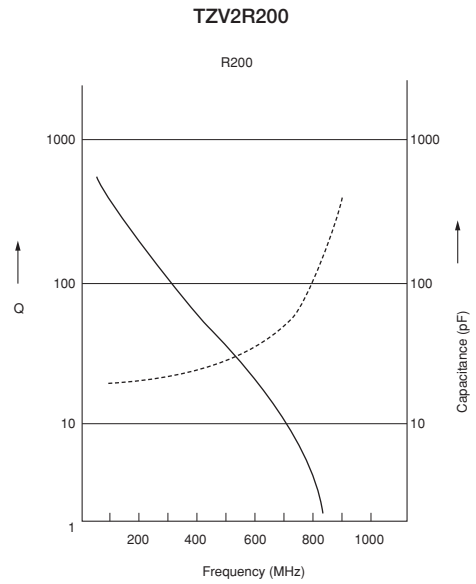
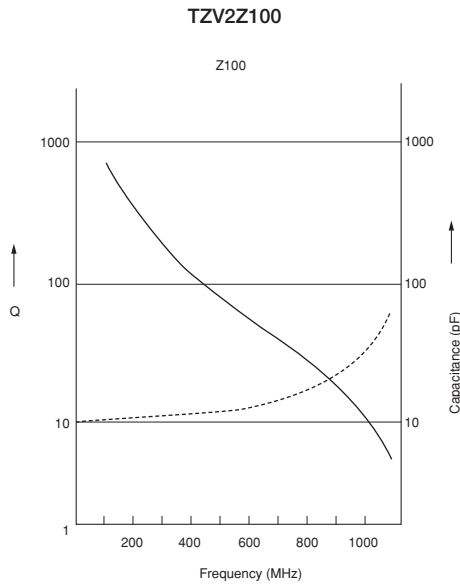

4

Land Pattern

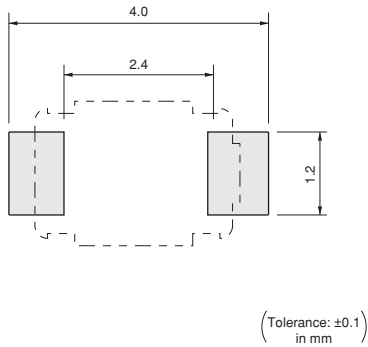

Temperature Profile

Reflow Soldering Profile

① Soldering profile for Lead-free solder (96.5Sn/3Ag/0.5Cu)

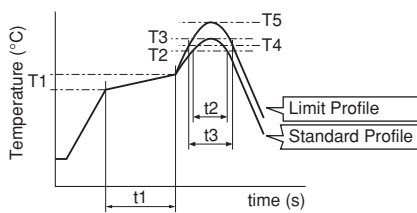

Standard Profile					
Pre-heating		Heating		Peak temperature (T3)	Cycle of reflow
Temp. (T1)	Time (t1)	Temp. (T2)	Time (t2)		
150 to 180°C	60 to 120sec.	220°C	30 to 60sec.	245±3°C	2 times

Limit Profile					
Pre-heating		Heating		Peak temperature (T5)	Cycle of reflow
Temp. (T1)	Time (t1)	Temp. (T4)	Time (t3)		
150 to 180°C	60 to 120sec.	230°C	30 to 50sec.	260 +5/-0°C	2 times

② Soldering profile for Eutectic solder (63Sn/37Pb)

(Limit profile: refer to ①)

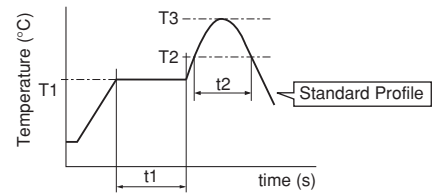

Standard Profile					
Pre-heating		Heating		Peak temperature (T3)	Cycle of reflow
Temp. (T1)	Time (t1)	Temp. (T2)	Time (t2)		
150°C	60 to 120sec.	183°C	30sec.	230 +5/-0°C	1 time

Soldering Iron

Standard Profile			
Temperature of soldering iron tip	Soldering time	Soldering iron power output	Cycle of soldering iron
350±10°C	3sec. max.	30W max.	1 time

■ Notice (Storage and Operating Conditions)

1. Do not use the trimmer capacitor under atmosphere of RTV silicone rubber (Room Temperature Vulcanizing Silicone Rubber) except Acetone liberating silicone sealant.
2. Before using trimmer capacitors, please store under the conditions of -10 to +40°C and 30 to 85%RH.
3. Do not store in or near corrosive gasses.
4. Use within 6 months of delivery.
5. Do not store under direct sunlight.

■ Notice (Soldering and Mounting)

1. Soldering
 - (1) TZV2 series can be soldered by reflow soldering method and soldering iron. Do not use flow soldering method (dipping).
 - (2) Soldering conditions
Refer to the temperature profile.
If the soldering conditions are not suitable, e.g., excessive time and/or excessive temperature, the trimmer capacitor may deviate from the specified characteristics.
 - (3) The amount of solder is critical.
 - (4) The thickness of solder paste should be printed from 120 micro m to 170 micro m and the dimension of land pattern should be Murata's standard land pattern used at reflow soldering.
Insufficient amounts of solder can lead to insufficient soldering strength on PCB.
Excessive amounts of solder may cause bridging between the terminals or contact failure due to flux wicking up.
 - (5) When using soldering iron, the diameter of the string solder shall be less than 0.5mm. The string solder shall be applied to the lower part of the terminal only. Do not apply flux except to the terminals. Excessive amounts of solder and/or applying solder to the upper part of the terminal may cause fixed metal rotor or contact failure due to flux invasion into

■ Notice (Handling)

1. Use suitable screwdrivers that fit comfortably in driver slot.
 - (1) Recommended screwdriver for manual adjustment
VESSEL: No.9000 -0.9x30
(Murata P/N : KMDR020)
 - (2) Recommended screwdriver bit for automatic adjustment
MURATA: KMBT020

■ Notice (Other)

Before using trimmer capacitors, please test after assembly in your particular mass production system.

6. Do not use the trimmer capacitor under the conditions listed below.
 - (1) Corrosive gasses atmosphere
(ex. Chlorine gas, Hydrogen sulfide gas, Ammonia gas, Sulfuric acid gas, Nitric oxide gas, etc.)
 - (2) In liquid (ex. water, oil, medical liquid, organic solvent, etc.)
 - (3) Dusty / dirty atmosphere
 - (4) Direct sunlight
 - (5) Static voltage or electric/magnetic fields
 - (6) Direct sea breeze
 - (7) Other variations of the above

the movable part and/or the contact point. The soldering iron should not come in contact with the monolithic stator of the trimmer capacitor.

If such contact does occur, the trimmer capacitor may be damaged.

- (6) Our recommended chlorine content of solder is as follows.
 - (a) Solder paste: 0.2wt% max.
 - (b) String solder: 0.5wt% max.
 - (7) Do not use water-soluble flux (for water cleaning). To prevent the deterioration of trimmer capacitor characteristics, apply flux only to terminals.
2. Mounting
 - (1) Do not apply excessive force (preferably 5.0 N [Ref: 500gf] max.), when the trimmer capacitor is mounted on the PCB.
 - (2) Do not warp and/or bend PCB to protect trimmer capacitor from breakage.
 - (3) Use a pick-up nozzle of a suitable dimension.
(2.5mm external diameter and 1.2mm bore diameter.)
 3. Cleaning
This product cannot be cleaned because of open construction.
 4. Other
Note the polarity of the trimmer capacitor to minimize influence by stray capacitance.
(Refer to the dimensions concerning the polarity.)

2. When adjusting with a screwdriver, do not apply excessive force (preferably 1.0 N [Ref: 100gf] max.) to minimize capacitance drift. Excessive force applied to the screwdriver slot may cause deformation of the products.
3. Do not apply adhesive, lock paints, or any other substances to the trimmer capacitor to secure the rotor position. They may cause corrosion or electrical contact problems.

Ceramic Trimmer Capacitors



TZC3 Series

■ Features

1. Small size with external dimension of 3.2(W)x4.5(L)x1.6(H)mm.
2. Color coded stator permits easy identification of capacitance and reduces mounting errors.
3. Can be adjusted with conventional adjustment tools having a thickness of 0.5mm.
4. Designed for automatic placement in surface mount applications.
5. Heat resistant resin withstands reflow soldering temperatures.

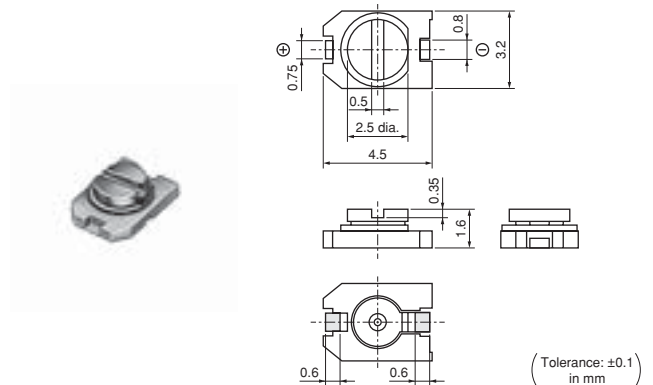

■ Applications

1. Compact radios
2. Headphones
3. Pagers
4. Portable radio equipment
5. Hybrid ICs
6. Cellular telephones
7. Cordless telephones
8. Remote keyless entry systems

5

Part Number	C min. (max.) (pF)	C max. (pF)	TC	Q	Rated Voltage	Withstanding Voltage	Stator/Case Color
TZC3Z030A110	1.4	3.0 +50/-0%	NP0±300ppm/°C	300min. at 1MHz, Cmax.	100Vdc	220Vdc	Brown
TZC3Z060A110	2.0	6.0 +50/-0%	NP0±300ppm/°C	500min. at 1MHz, Cmax.	100Vdc	220Vdc	Blue
TZC3R100A110	3.0	10.0 +50/-0%	N750±300ppm/°C	500min. at 1MHz, Cmax.	100Vdc	220Vdc	White
TZC3P200A110	5.0	20.0 +50/-0%	N1200±500ppm/°C	300min. at 1MHz, Cmax.	100Vdc	220Vdc	Red
TZC3P300A110	6.5	30.0 +50/-0%	N1200±500ppm/°C	300min. at 1MHz, Cmax.	100Vdc	220Vdc	Green

Insulation Resistance: 10000M ohm Torque: 1.5 to 9.8mNm Operating Temperature Range: -25 to +85°C

■ Construction

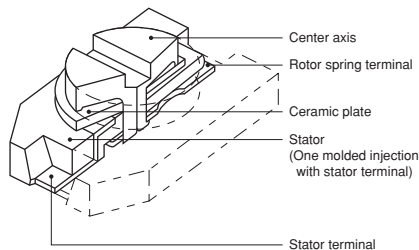

■ Temperature Characteristics

TZC3Z030

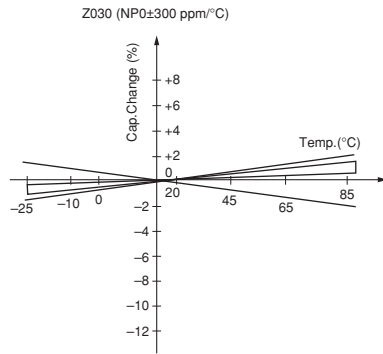

TZC3Z060

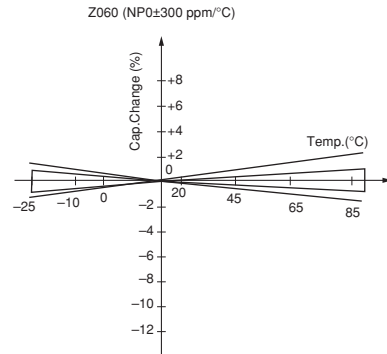

TZC3R100

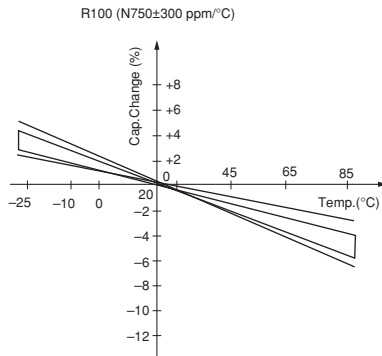

TZC3P200

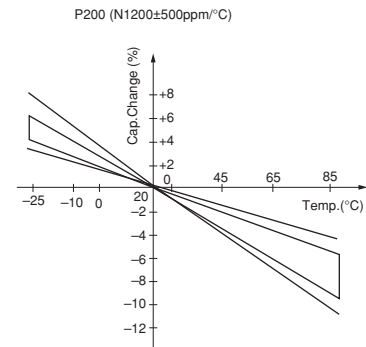

5

■ Frequency Characteristics

TZC3Z030

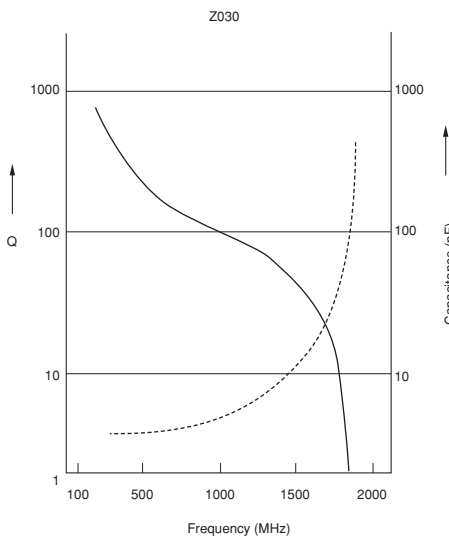

TZC3Z060

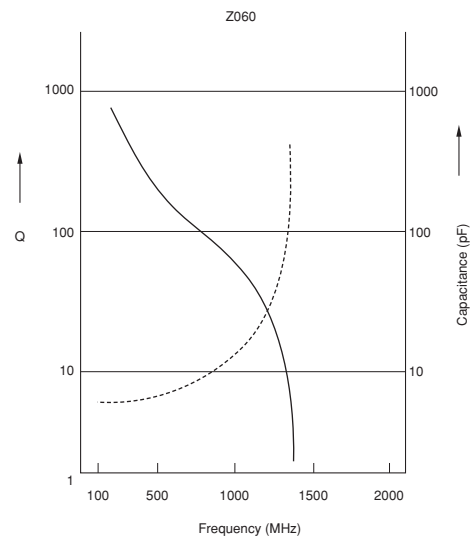

Continued on the following page.

Continued from the preceding page.

Frequency Characteristics

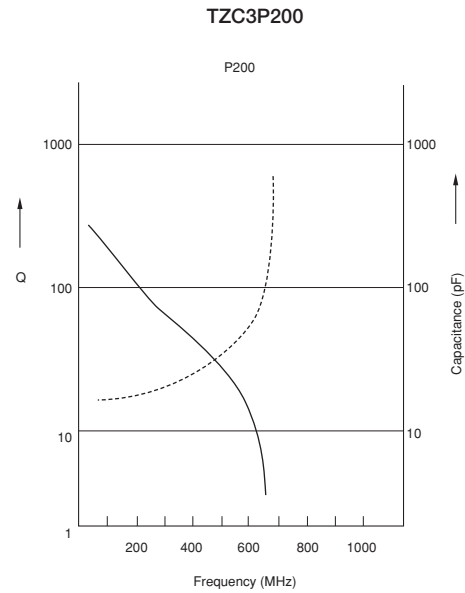
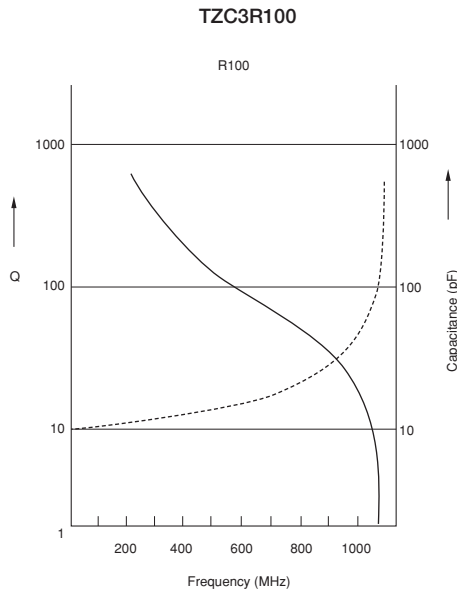

Land Pattern

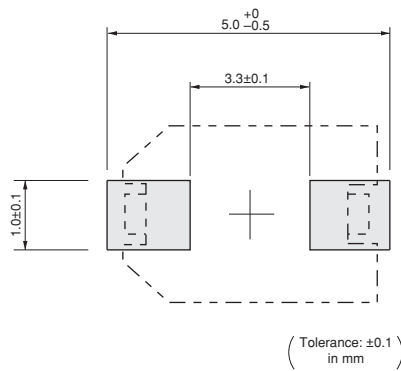

5

Temperature Profile

Reflow Soldering Profile

① Soldering profile for Lead-free solder (96.5Sn/3Ag/0.5Cu)

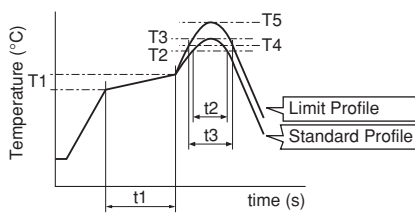

Standard Profile					
Pre-heating		Heating		Peak temperature (T3)	Cycle of reflow
Temp. (T1)	Time (t1)	Temp. (T2)	Time (t2)		
150 to 180°C	60 to 120sec.	220°C	30 to 60sec.	245±3°C	2 times

Limit Profile					
Pre-heating		Heating		Peak temperature (T5)	Cycle of reflow
Temp. (T1)	Time (t1)	Temp. (T4)	Time (t3)		
150 to 180°C	60 to 120sec.	230°C	30 to 50sec.	260 +5/-0°C	2 times

② Soldering profile for Eutectic solder (63Sn/37Pb)

(Limit profile: refer to ①)

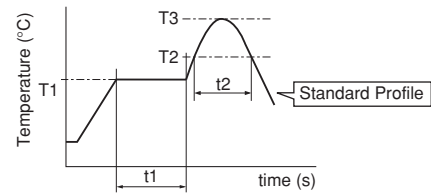

Standard Profile					
Pre-heating		Heating		Peak temperature (T3)	Cycle of reflow
Temp. (T1)	Time (t1)	Temp. (T2)	Time (t2)		
150°C	60 to 120sec.	183°C	30sec.	230 +5/-0°C	1 time

Soldering Iron

Standard Profile			
Temperature of soldering iron tip	Soldering time	Soldering iron power output	Cycle of soldering iron
350±10°C	3sec. max.	30W max.	1 time

■ Notice (Storage and Operating Conditions)

1. Do not use the trimmer capacitor under atmosphere of RTV silicone rubber (Room Temperature Vulcanizing Silicone Rubber) except Acetone liberating silicone sealant.
2. Before using trimmer capacitors, please store under the conditions of -10 to +40°C and 30 to 85%RH.
3. Do not store in or near corrosive gasses.
4. Use within 6 months of delivery.
5. Do not store under direct sunlight.

■ Notice (Soldering and Mounting)

1. Soldering

- (1) TZC3 series can be soldered by reflow soldering method and soldering iron. Do not use flow soldering method (dipping).
- (2) Soldering conditions
Refer to the temperature profile.
If the soldering conditions are not suitable, e.g., excessive time and/or excessive temperature, the trimmer capacitor may deviate from the specified characteristics.
- (3) The amount of solder is critical.
- (4) The thickness of solder paste should be printed from 150 micro m to 200 micro m and the dimension of land pattern should be Murata's standard land pattern used at reflow soldering.
Insufficient amounts of solder can lead to insufficient soldering strength on PCB.
Excessive amounts of solder may cause bridging between the terminals or contact failure due to flux wicking up.
- (5) When using soldering iron, the diameter of the string solder shall be less than 0.5mm. The string solder shall be applied to the lower part of the terminal only. Do not apply flux except to the terminals. Excessive amounts of solder and/or applying solder to the upper part of the terminal may cause fixed metal rotor or contact failure due to flux invasion into the movable part and/or the contact point. The

■ Notice (Handling)

1. Use suitable screwdrivers that fit comfortably in driver slot.
 - (1) Recommended screwdriver for manual adjustment
Standard type --> MURATA: KMDR010
Cross slot type --> VESSEL: NO.9000+1.7×30
(Murata P/N is KMDR080)
 - (2) Recommended screwdriver bit for automatic adjustment
Standard type --> MURATA: KMBT010
Cross slot type --> VESSEL: No.CA-11
(Murata P/N is KMBT080)

■ Notice (Other)

Before using trimmer capacitors, please test after assembly in your particular mass production system.

6. Do not use the trimmer capacitor under the conditions listed below.
 - (1) Corrosive gasses atmosphere
(ex. Chlorine gas, Hydrogen sulfide gas, Ammonia gas, Sulfuric acid gas, Nitric oxide gas, etc.)
 - (2) In liquid (ex. water, oil, medical liquid, organic solvent, etc.)
 - (3) Dusty / dirty atmosphere
 - (4) Direct sunlight
 - (5) Static voltage or electric/magnetic fields
 - (6) Direct sea breeze
 - (7) Other variations of the above

soldering iron should not come in contact with the stator of the trimmer capacitor. If such contact does occur, the trimmer capacitor may be damaged.

- (6) Our recommended chlorine content of solder is as follows.
 - (a) Solder paste: 0.2wt% max.
 - (b) String solder: 0.5wt% max.
 - (7) Do not use water-soluble flux (for water cleaning).
To prevent the deterioration of trimmer capacitor characteristics, apply flux only to terminals.
 - (8) When soldering the TZC3 series, the solder should not flow into the staking part of the substrate. If such flow does occur, driver slot rotation will be damaged.
- #### 2. Mounting
- (1) Do not apply excessive force (preferably 5.0 N [Ref: 500gf] max.), when the trimmer capacitor is mounted on the PCB.
 - (2) Do not warp and/or bend PCB to protect trimmer capacitor from breakage.
 - (3) Use a pick-up nozzle of a suitable dimension.
(2.5mm external diameter and 1.5mm bore diameter.)
- #### 3. Cleaning
- This product cannot be cleaned because of open construction.
- #### 4. Other
- Note the polarity of the trimmer capacitor to minimize influence by stray capacitance.
(Refer to the dimensions concerning the polarity.)

2. When adjusting with a screwdriver, do not apply excessive force (preferably 1.0 N [Ref: 100gf] max.) to minimize capacitance drift. Excessive force applied to the screwdriver slot may cause deformation of the products.
3. Do not apply adhesive, lock paints, or any other substances to the trimmer capacitor to secure the rotor position. They may cause corrosion or electrical contact problems.

Ceramic Trimmer Capacitors



TZW4 Series

■ Features

1. To meet high power application due to withstanding voltage 550Vdc.
2. Extremely high self-resonant frequency.
(More than 3GHz at rated Cmax.)
3. Typical application: Impedance matching for Cellular Base Station.
4. High Q value in more than VHF, UHF and Microwave bands.
(More than 200 in 500MHz, C max.)
5. Available for pick and place machine. Possible thinner design due to 2.6mm low profile.
6. Non-electrical contact construction
(rotor as middle electrode) provides high reliability.
7. Compact size: 4.2(W)x5.2(L)x2.6max.(H)mm.

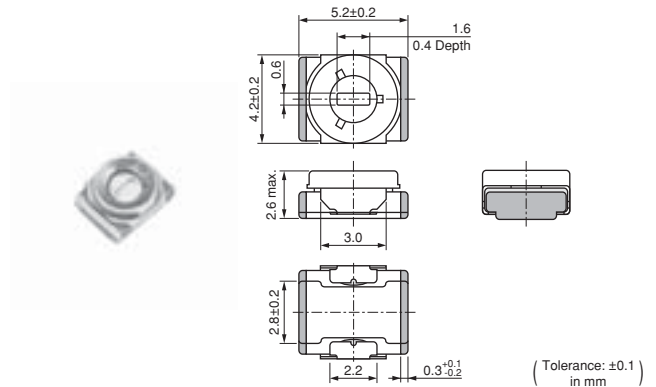

■ Applications

1. Transmitting power amplifier for Cellular base station
2. Transmitting amplifier for PHS base station
3. High frequency electric circuit
4. High power radio transmission
5. Transponder amplifier for cable TV

Part Number	C min. (max.) (pF)	C max. (pF)	TC	Q	Rated Voltage	Withstanding Voltage
TZW4Z010A001	0.4	1.0 +50/-0%	NP0±150ppm/°C	200min. at 500MHz, Cmax.	250Vdc	550Vdc
TZW4Z1R5A001	0.4	1.5 +100/-0%	NP0±150ppm/°C	200min. at 500MHz, Cmax.	250Vdc	550Vdc

Insulation Resistance: 10000M ohm Torque: 1.5 to 10.0mNm Operating Temperature Range: -55 to +125°C

■ Construction

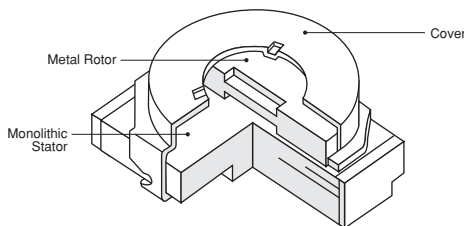

■ Temperature Characteristics

TZW4Z1R5

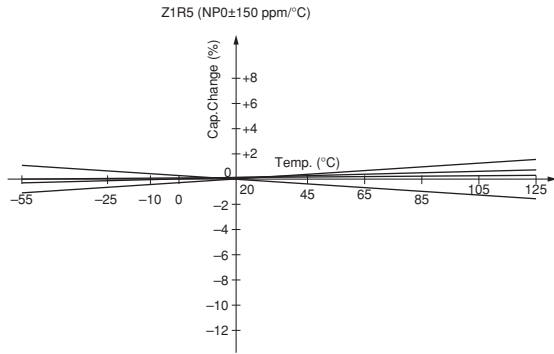

■ Frequency Characteristics

TZW4Z1R5

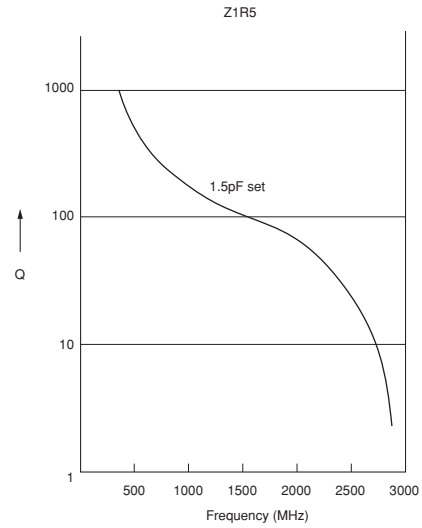

■ Land Pattern

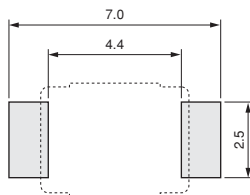

(Tolerance: ±0.1 in mm)

■ Temperature Profile

● Reflow Soldering Profile

① Soldering profile for Lead-free solder (96.5Sn/3Ag/0.5Cu)

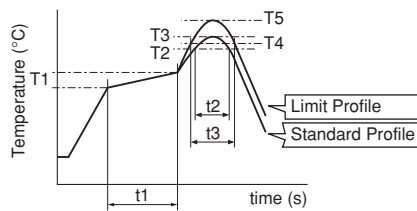

Standard Profile					
Pre-heating		Heating		Peak temperature (T3)	Cycle of reflow
Temp. (T1)	Time (t1)	Temp. (T2)	Time (t2)		
150 to 180°C	60 to 120sec.	220°C	30 to 60sec.	245±3°C	2 times

Limit Profile					
Pre-heating		Heating		Peak temperature (T5)	Cycle of reflow
Temp. (T1)	Time (t1)	Temp. (T4)	Time (t3)		
150 to 180°C	60 to 120sec.	230°C	30 to 50sec.	260 +5/-0°C	2 times

② Soldering profile for Eutectic solder (63Sn/37Pb)

(Limit profile: refer to ①)

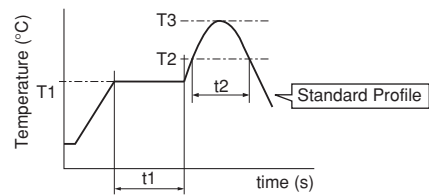

Standard Profile					
Pre-heating		Heating		Peak temperature (T3)	Cycle of reflow
Temp. (T1)	Time (t1)	Temp. (T2)	Time (t2)		
150°C	60 to 120sec.	183°C	30sec.	230 +5/-0°C	1 time

● Soldering Iron

Standard Profile			
Temperature of soldering iron tip	Soldering time	Soldering iron power output	Cycle of soldering iron
350±10°C	3sec. max.	30W max.	1 time

■ Notice (Storage and Operating Conditions)

1. Do not use the trimmer capacitor under atmosphere of RTV silicone rubber (Room Temperature Vulcanizing Silicone Rubber) except Acetone liberating silicone sealant.
2. Before using trimmer capacitors, please store under the conditions of -10 to +40°C and 30 to 85%RH.
3. Do not store in or near corrosive gasses.
4. Use within 6 months of delivery.
5. Do not store under direct sunlight.

■ Notice (Soldering and Mounting)

1. Soldering
 - (1) TZW4 series can be soldered by reflow soldering method and soldering iron. Do not use flow soldering method (dipping).
 - (2) Soldering conditions
Refer to the temperature profile.
If the soldering conditions are not suitable, e.g., excessive time and/or excessive temperature, the trimmer capacitor may deviate from the specified characteristics.
 - (3) The amount of solder is critical.
 - (4) The thickness of solder paste should be printed from 150 micro m to 200 micro m and the dimension of land pattern should be Murata's standard land pattern used at reflow soldering.
Insufficient amounts of solder can lead to insufficient soldering strength on PCB.
Excessive amounts of solder may cause bridging between the terminals or contact failure due to flux wicking up.
 - (5) When using soldering iron, the diameter of the string solder shall be less than 0.5mm. The string solder shall be applied to the lower part of the terminal only. Do not apply flux except to the terminals. Excessive amounts of solder and/or applying solder to the upper part

■ Notice (Handling)

1. Use suitable screwdrivers that fit comfortably in driver slot.
-Recommended screwdriver for manual adjustment
VESSEL : No.9000 -1.3x30
(Murata P/N is KMDR130)
2. When adjusting with a screwdriver, do not apply excessive force (preferably 1.0 N [Ref: 100gf] max.) to minimize capacitance drift. Excessive force applied to the screwdriver slot may cause deformation of the products.

■ Notice (Other)

Before using trimmer capacitors, please test after assembly in your particular mass production system.

6. Do not use the trimmer capacitor under the conditions listed below.
 - (1) Corrosive gasses atmosphere
(Ex. Chlorine gas, Hydrogen sulfide gas, Ammonia gas, Sulfuric acid gas, Nitric oxide gas, etc.)
 - (2) In liquid (Ex. water, oil, medical liquid, organic solvent, etc.)
 - (3) Dusty/dirty atmosphere
 - (4) Direct sunlight
 - (5) Static voltage or electric/magnetic fields
 - (6) Direct sea breeze
 - (7) Other variations of the above

of the terminal may cause fixed metal rotor or the contact failure due to flux invasion into the movable part and/or the contact point. The soldering iron should not come in contact with the monolithic stator of the trimmer capacitor. If such contact does occur, the trimmer capacitor may be damaged.

- (6) Our recommended chlorine content of solder is as follows.
 - (a) Solder paste: 0.2wt% max.
 - (b) String solder: 0.5wt% max.
 - (7) Do not use water-soluble flux (for water cleaning). To prevent the deterioration of trimmer capacitor characteristics, apply flux only to terminals.
2. Mounting
 - (1) Do not apply excessive force (preferably 5.0 N [Ref: 500gf] max.), when the trimmer capacitor is mounted on the PCB.
 - (2) Do not warp and/or bend PCB to protect trimmer capacitor from breaking.
 - (3) Use a pick-up nozzle of a suitable dimension. (4.0mm external diameter and 1.2mm bore diameter.)
 3. Cleaning
This product cannot be cleaned because of open construction.

3. Do not apply adhesive, lock paints, or any other substances to the trimmer capacitor to secure the rotor position. They may cause corrosion or electrical contact problems.

Ceramic Trimmer Capacitors



TZB4 Series

■ Features

1. Miniature rectangular shape:
4.0(W)x4.5(L)x3.0(H)mm.
2. Color coded case facilitates identification of capacitance range.
3. Designed for automatic placement in surface mount applications.
4. Designed to withstand flux baths and solder baths (with cover film type).
5. Can be temporarily attached to PCB with adhesives (Terminal style A and B).
6. Can be reflow and flow (with cover film type) soldering method.
7. Stable characteristics over a wide frequency range. (Resonant frequency: 1000MHz min. / 6pF)

■ Applications

1. Car audio systems
2. Cordless telephones
3. Hybrid ICs
4. Pagers
5. Remote keyless entry systems
6. Tuner packs
7. Surveillance cameras
8. DVD
9. Burglarproof devices

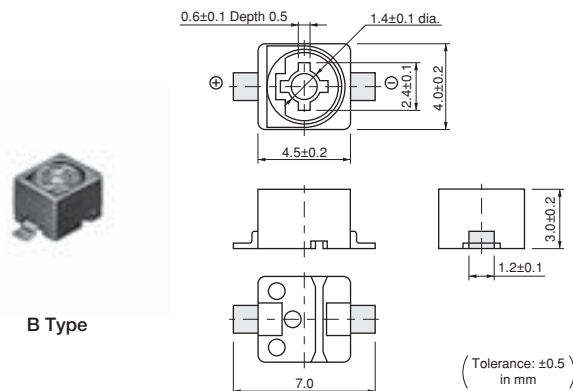
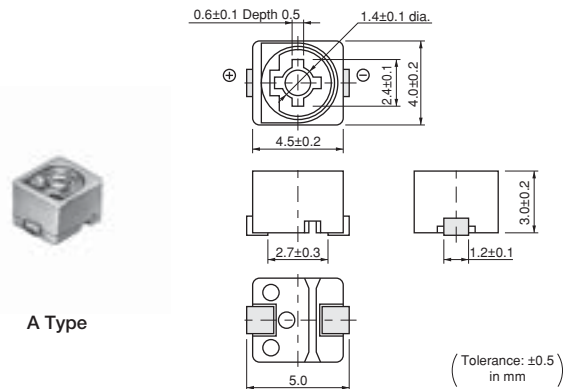

Part Number	C min. (max.) (pF)	C max. (pF)	TC	Q	Rated Voltage	Withstanding Voltage	Stator/Case Color
TZB4Z030□□10	1.4	3.0 +50/-0%	NP0±200ppm/°C	300min. at 1MHz, Cmax	100Vdc	220Vdc	Brown
TZB4Z060□□10	2.0	6.0 +50/-0%	NP0±200ppm/°C	500min. at 1MHz, Cmax.	100Vdc	220Vdc	Blue
TZB4Z100□□10	3.0	10.0 +50/-0%	NP0±300ppm/°C	500min. at 1MHz, Cmax.	100Vdc	220Vdc	White
TZB4R200□□10	4.5	20.0 +50/-0%	N750±400ppm/°C	500min. at 1MHz, Cmax	100Vdc	220Vdc	Red
TZB4P300□□10	6.5	30.0 +50/-0%	N1200±500ppm/°C	300min. at 1MHz, Cmax	100Vdc	220Vdc	Green
TZB4P400□□10	8.5	40.0 +50/-0%	N1200±500ppm/°C	300min. at 1MHz, Cmax	100Vdc	220Vdc	Yellow
TZB4Z250□□10	4.0	25.0 +100/-0%	NP0±300ppm/°C	300min. at 1MHz, Cmax.	50Vdc	110Vdc	Black+Marking
TZB4R500□□10	7.0	50.0 +100/-0%	N750±300ppm/°C	300min. at 1MHz, Cmax	50Vdc	110Vdc	Black+Marking

Insulation Resistance: 10000M ohm Torque: 1.5 to 9.8mNm Operating Temperature Range: -25 to +85°C
 First blank: Terminal Type Second blank: Cover film codes (A: not provided, B: provided)
 ex. TZB4Z100A□10: Terminal Type is A, and Cover film is provided.

■ Construction

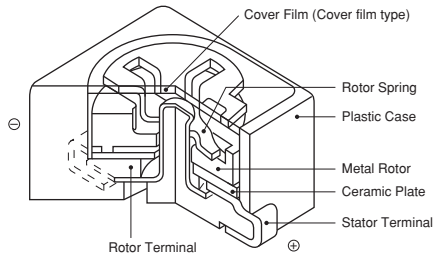

■ Land Pattern/Mounting Holes

A Type

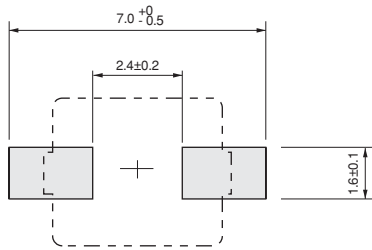

(in mm)

B Type

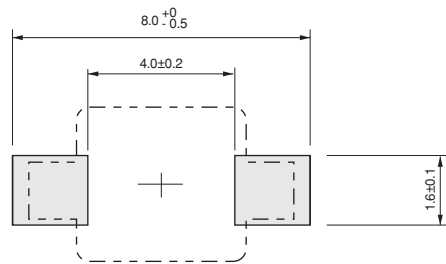

(in mm)

■ Temperature Characteristics

TZB4Z060

Z060 (NP0 ± 200ppm/°C)

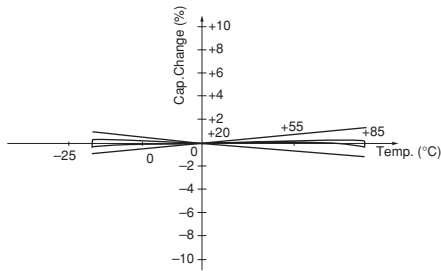

TZB4Z100

Z100 (NP0 ± 300ppm/°C)

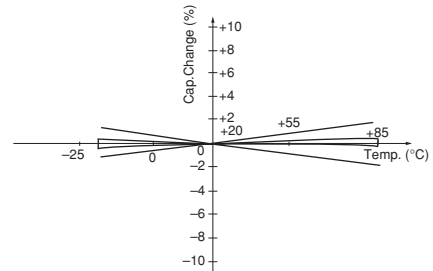

TZB4R200

R200 (N750 ± 400ppm/°C)

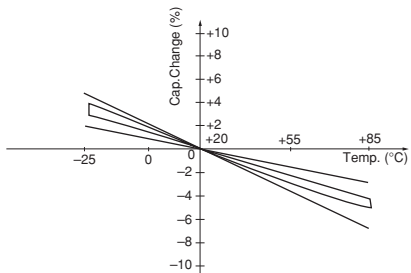

TZB4R500

R500 (N750 ± 300ppm/°C)

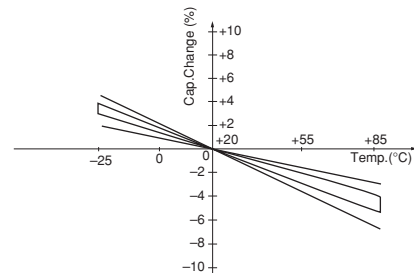

7

■ Frequency Characteristics

TZB4Z060

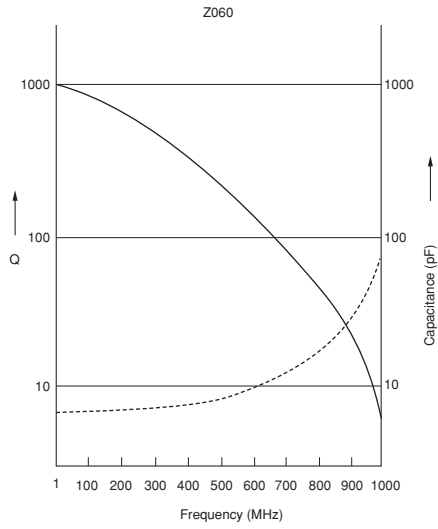

TZB4Z100

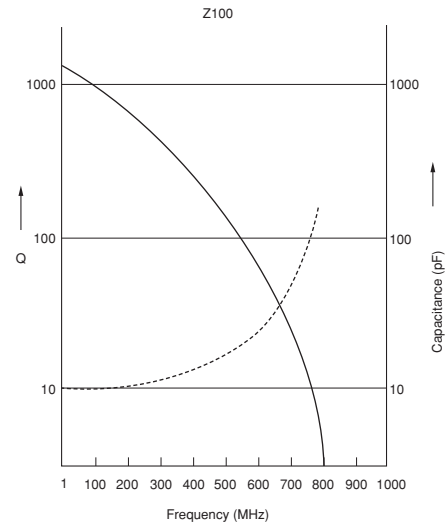

TZB4R200

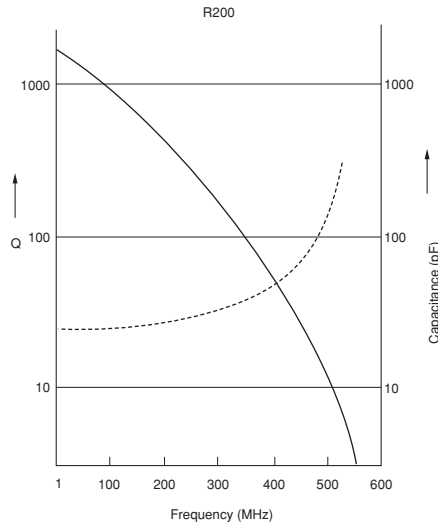

TZB4R500

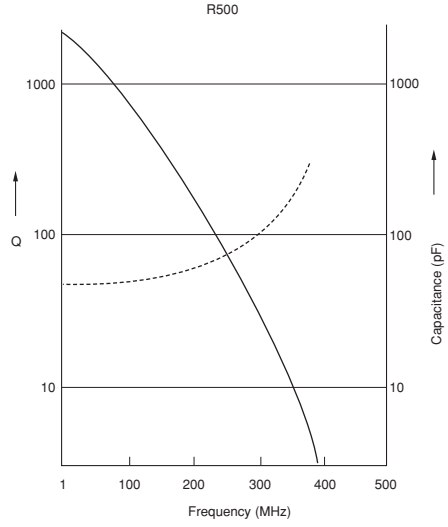

Temperature Profile

Flow Soldering Profile

Soldering profile for Lead-free solder (96.5Sn/3Ag/0.5Cu), Eutectic solder (63Sn/37Pb)

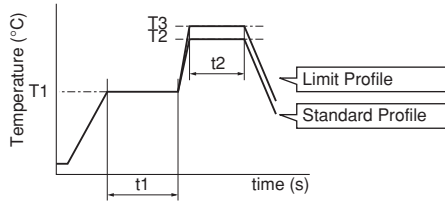

• Immerse the body in solder bath, available for cover film type.

Standard Profile				
Pre-heating		Heating		Cycle of reflow
Temp. (T1)	Time (t1)	Temp. (T2)	Time (t2)	
150°C	60 to 120sec.	250°C	5sec. max.	1 time

Limit Profile				
Pre-heating		Heating		Cycle of reflow
Temp. (T1)	Time (t1)	Temp. (T3)	Time (t2)	
150°C	60 to 120sec.	265±3°C	5sec. max.	2 times

Reflow Soldering Profile

① Soldering profile for Lead-free solder (96.5Sn/3Ag/0.5Cu)

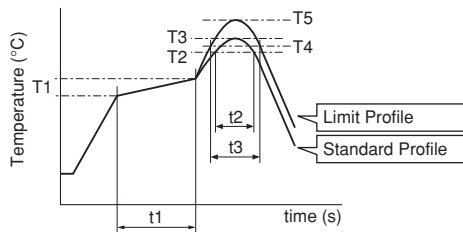

Standard Profile					
Pre-heating		Heating		Peak temperature (T3)	Cycle of reflow
Temp. (T1)	Time (t1)	Temp. (T2)	Time (t2)		
150 to 180°C	60 to 120sec.	220°C	30 to 60sec.	245±3°C	2 times

Limit Profile					
Pre-heating		Heating		Peak temperature (T5)	Cycle of reflow
Temp. (T1)	Time (t1)	Temp. (T4)	Time (t3)		
150 to 180°C	60 to 120sec.	230°C	30 to 50sec.	260 +5/-0°C	2 times

• Available for terminal shape A, B, and E.

② Soldering profile for Eutectic solder (63Sn/37Pb)

(Limit profile: refer to ①)

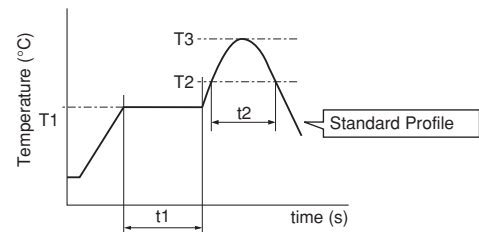

Standard Profile					
Pre-heating		Heating		Peak temperature (T3)	Cycle of reflow
Temp. (T1)	Time (t1)	Temp. (T2)	Time (t2)		
150°C	60 to 120sec.	183°C	30sec.	230 +5/-0°C	1 time

Soldering Iron

Standard Profile			
Temperature of soldering iron tip	Soldering time	Soldering iron power output	Cycle of soldering iron
350±10°C	3sec. max.	30W max.	1 time

Notice (Storage and Operating Conditions)

- Do not use the trimmer capacitor under atmosphere of RTV silicone rubber (Room Temperature Vulcanizing Silicone Rubber) except Acetone liberating silicone sealant.
- Before using trimmer capacitors, please store under the conditions of -10 to +40°C and 30 to 85%RH.
- Do not store in or near corrosive gasses.
- Use within 6 months of delivery.
- Do not store under direct sunlight.
- Do not use the trimmer capacitor under the conditions listed below.
 - Corrosive gasses atmosphere (ex. Chlorine gas, Hydrogen sulfide gas, Ammonia gas, Sulfuric acid gas, Nitric oxide gas, etc.)
 - In liquid (ex. water, oil, medical liquid, organic solvent, etc.)
 - Dusty / dirty atmosphere
 - Direct sunlight
 - Static voltage or electric/magnetic fields
 - Direct sea breeze
 - Other variations of the above

■ Notice (Soldering and Mounting)

1. Soldering

- (1) Can be soldered by reflow soldering method, flow soldering method, and soldering iron.
- (2) Soldering conditions
Refer to the temperature profile.
If the soldering conditions are not suitable, e.g., excessive time and/or excessive temperature, the trimmer capacitor may deviate from the specified characteristics.
- (3) The amount of solder is critical.
- (4) The thickness of solder paste should be printed from 150 micro m to 200 micro m and the dimension of land pattern should be Murata's standard land pattern used at reflow soldering. Insufficient amounts of solder can lead to insufficient soldering strength on PCB. Excessive amounts of solder may cause bridging between the terminals or contact failure due to flux wicking up.
- (5) When using soldering iron, the string solder shall be applied to the lower part of the terminal only. Do not apply flux except to the terminals. Excessive amounts of solder and/or applying solder to the upper part of the terminal may cause fixed rotor or contact failure due to flux invasion into the movable part and/or the contact point. The soldering iron should not come in contact with the plastic case of the trimmer capacitor. If such contact does occur, the trimmer capacitor may be damaged.
- (6) Our recommended chlorine content of solder is as follows.
 - (a) Solder paste: 0.2wt% max.
 - (b) String solder: 0.5wt% max.

- (7) Do not use water-soluble flux (for water cleaning). To prevent the deterioration of trimmer capacitor characteristics, apply flux only to terminals.

2. Mounting

- (1) Do not apply excessive force (preferably 5.0N [Ref: 500gf] max.), when the trimmer capacitor is mounted on the PCB.
- (2) Do not warp and/or bend PCB to protect trimmer capacitor from breakage.
- (3) When bending the terminals, do not apply excessive force to the body of the product to protect the terminal fixing part from damage.
- (4) Use a pick-up nozzle of a suitable dimension.
 - > Without cover film type
 - External dimensions of 4.5x4.0mm and 2.5mm bore diameter.
 - > With cover film type
 - 4.0mm external diameter and 2.0mm bore diameter.

3. Cleaning [with cover film type]

Isopropyl alcohol and ethyl alcohol are available material for cleaning. If you use any other type of solvent, please evaluate performance in your application. Moreover, please confirm that no damage has occurred to the trimmer capacitor after cleaning in your conditions.

4. Other

Note the polarity of the trimmer capacitor to minimize influence by stray capacitance. (Refer to the dimensions concerning the polarity.)

■ Notice (Handling)

1. Use suitable screwdrivers that fit comfortably in driver slot.

- (1) Recommended screwdriver for manual adjustment
MURATA: KMDR010
- (2) Recommended screwdriver bit for automatic adjustment
MURATA: KMBT010

2. When adjusting with a screwdriver, do not apply excessive force (preferably 1.0 N [Ref: 100gf] max.) to minimize capacitance drift. Excessive force applied to the screwdriver slot may cause deformation of the products.

3. Do not apply adhesive, lock paints, or any other substances to the trimmer capacitor to secure the rotor position. They may cause corrosion or electrical contact problems.
4. Do not break the cover film before the completion of PCB mounting, soldering, and cleaning.
5. Do not clean the trimmer capacitor after the cover film has been broken.
6. To break the cover film, first turn the screwdriver more than 360°, and set the capacitance value. (Inserting the screwdriver only will not break the cover film.)

■ Notice (Other)

Before using trimmer capacitors, please test after assembly in your particular mass production system.

Packaging

Minimum Quantity

Part Number	Minimum Quantity (pcs.)		
	ø180mm Reel	ø330mm Reel	Bulk
TZR1	3000	-	500
TZS2	3000	-	500
TZY2	2000	-	500
TZV2	2000	-	500
TZC3	1000	-	500
TZW4	500	-	100
TZB4	500	2500	500

Tape Dimensions

TZR1 Series

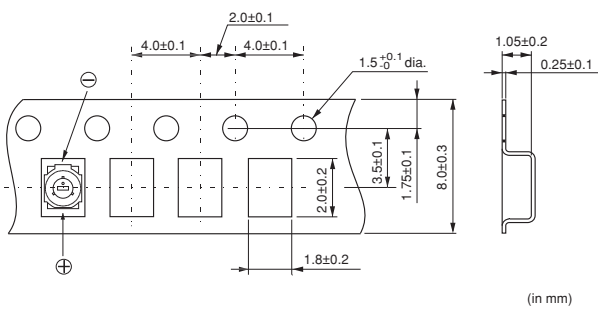

TZS2 Series

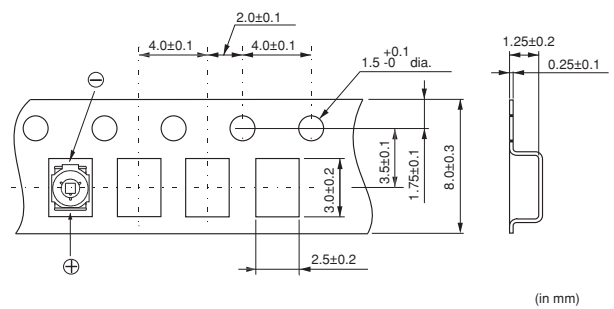

TZY2/TZV2 Series

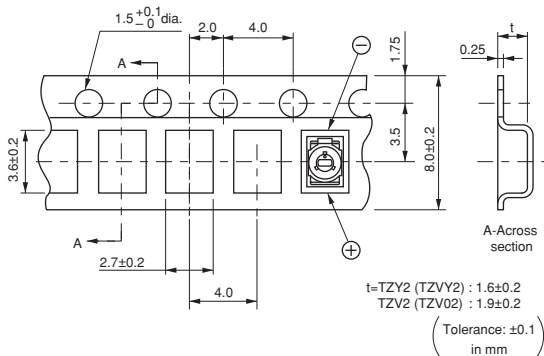

TZC3 Series

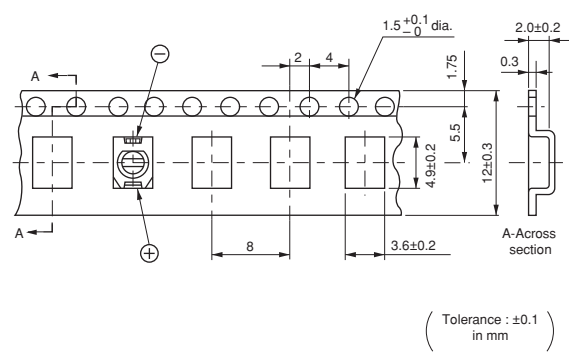

TZW4 Series

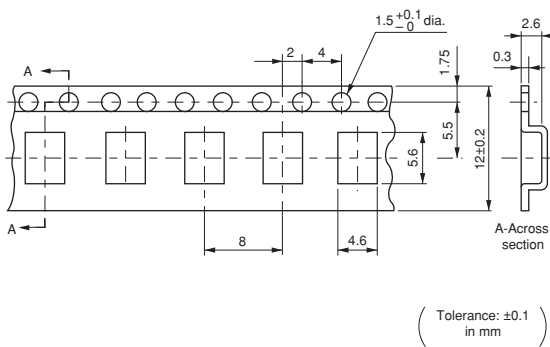

TZB4 Series

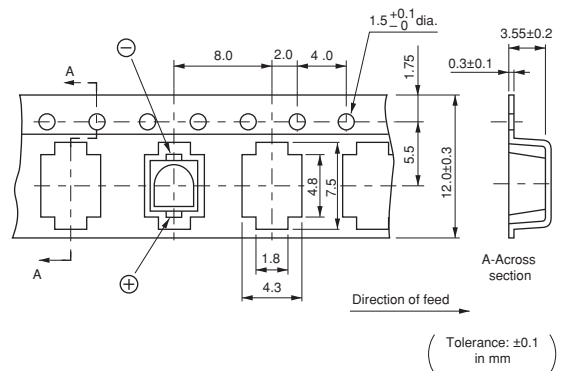

Continued on the following page. ↗

Packaging

☐ Continued from the preceding page.

■ Reel Dimensions (180mm diameter)

TZR1/TZS2/TZY2/TZV2 Series

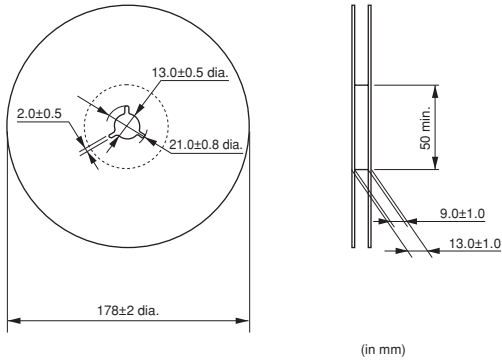

TZC3/TZW4/TZB4 Series

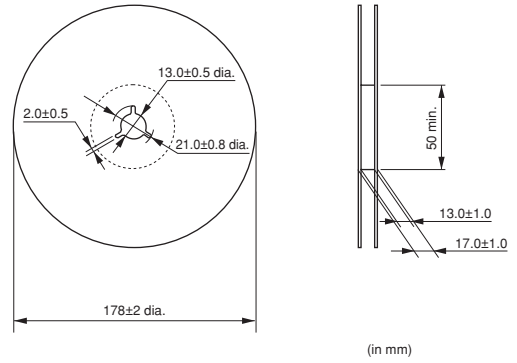

■ Reel Dimensions (330mm diameter)

TZB4 Series

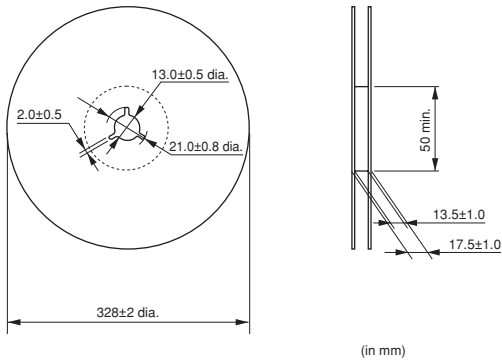

Recommended Adjustment Tools

Please use the following recommended screwdrivers.

You can order these drivers using the part numbers below.

Although you can also adjust the capacitance value using commercial products, please use one with the same head size as the driver listed below.

■ For Manual Adjustment



Series	MURATA Model Number	Manufacturer's Model Number	Shape
TZR1	KMDR160	MURATA MFG. KMDR160	<p>Bit shape: ⊖ Minus (0.3x0.13)</p> <p>(in mm)</p>
TZS2	KMDR050	MURATA MFG. KMDR050	<p>Bit shape: Square (0.54x0.54)</p> <p>(in mm)</p>
TZY2	KMDR060	ENGINEER INC. DA-89	<p>Bit shape: ⊖ Minus (0.8x0.35)</p> <p>(in mm)</p>
TZV2	KMDR020	VESSEL MFG. NO.9000 -0.9×30	<p>Bit shape: ⊖ Minus (0.9x0.4)</p> <p>(in mm)</p>
TZC3 TZB4	KMDR010	MURATA MFG. KMDR010	<p>Bit shape: ⊖ Minus (2.2x0.4)</p> <p>(in mm)</p>
TZW4	KMDR130	VESSEL MFG. NO.9000 -1.3×30	<p>Bit shape: ⊖ Minus (1.3x30)</p> <p>(in mm)</p>

Continued on the following page.

Recommended Adjustment Tools

☐ Continued from the preceding page.

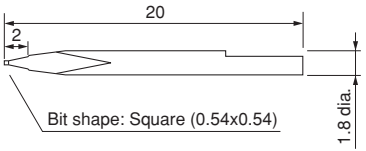
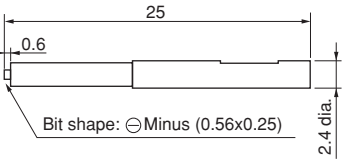
■ For Automatic Adjustment

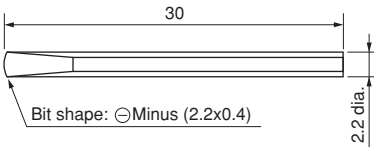
Series	MURATA Model Number	Manufacturer's Model Number	Shape
TZS2	KMBT050	MURATA MFG. KMBT050	 <p style="text-align: right;">(in mm)</p>
TZY2	KMBT060	MURATA MFG. KMBT060	 <p style="text-align: right;">(in mm)</p>
TZV2	KMBT020	MURATA MFG. KMBT020	 <p style="text-align: right;">(in mm)</p>
TZC3 TZB4	KMBT010	MURATA MFG. KMBT010	 <p style="text-align: right;">(in mm)</p>

Qualified Standards

The products listed herein have been produced
by a ISO9001 certified factory

MURATA FACTORY

Sabae Murata Mfg. Co., Ltd.

* No ODCs (Ozone Depleting Chemicals) are used on
any Murata trimmer potentiometers.

⚠Note:

1. Export Control

<For customers outside Japan>

No Murata products should be used or sold, through any channels, for use in the design, development, production, utilization, maintenance or operation of, or otherwise contribution to (1) any weapons (Weapons of Mass Destruction [nuclear, chemical or biological weapons or missiles] or conventional weapons) or (2) goods or systems specially designed or intended for military end-use or utilization by military end-users.

<For customers in Japan>

For products which are controlled items subject to the "Foreign Exchange and Foreign Trade Law" of Japan, the export license specified by the law is required for export.

2. Please contact our sales representatives or product engineers before using the products in this catalog for the applications listed below, which require especially high reliability for the prevention of defects which might directly damage a third party's life, body or property, or when one of our products is intended for use in applications other than those specified in this catalog.

- | | |
|-----------------------------|--|
| ① Aircraft equipment | ② Aerospace equipment |
| ③ Undersea equipment | ④ Power plant equipment |
| ⑤ Medical equipment | ⑥ Transportation equipment (vehicles, trains, ships, etc.) |
| ⑦ Traffic signal equipment | ⑧ Disaster prevention / crime prevention equipment |
| ⑨ Data-processing equipment | ⑩ Application of similar complexity and/or reliability requirements to the applications listed above |

3. Product specifications in this catalog are as of September 2013. They are subject to change or our products in it may be discontinued without advance notice.

Please check with our sales representatives or product engineers before ordering. If there are any questions, please contact our sales representatives or product engineers.

4. Please read rating and ⚠CAUTION (for storage, operating, rating, soldering, mounting and handling) in this catalog to prevent smoking and/or burning, etc.

5. This catalog has only typical specifications. Therefore, please approve our product specifications or transact the approval sheet for product specifications before ordering.

6. Please note that unless otherwise specified, we shall assume no responsibility whatsoever for any conflict or dispute that may occur in connection with the effect of our and/or a third party's intellectual property rights and other related rights in consideration of your use of our products and/or information described or contained in our catalogs. In this connection, no representation shall be made to the effect that any third parties are authorized to use the rights mentioned above under licenses without our consent.

7. No ozone depleting substances (ODS) under the Montreal Protocol are used in our manufacturing process.

 **Murata Manufacturing Co., Ltd.**

<http://www.murata.com/>

Head Office
1-10-1, Higashi Kotari, Nagaokakyo-shi, Kyoto 617-8555, Japan
Phone: 81-75-951-9111

International Division
3-29-12, Shibuya, Shibuya-ku, Tokyo 150-0002, Japan
Phone: 81-3-5469-6123 Fax: 81-3-5469-6155 E-mail: intl@murata.co.jp

单击下面可查看定价，库存，交付和生命周期等信息

[>>Murata\(村田\)](#)

[>>点击查看相关商品](#)