

SF2079D-1

**251.045 MHz
SAW Filter**

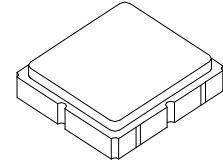

SM3838-8

- High Performance SAW Filter
- 3.8 X 3.8 X 1 mm Surface-mount Case
- Differential Input and Output
- Complies with Directive 2002/95/EC (RoHS)



Absolute Maximum Ratings

Rating	Value	Units
Maximum Incident Power in Passband	+10	dBm
Maximum DC Voltage Between any Two Terminals	30	VDC
Operating Temperature Range	-40 to +85	°C
Storage Temperature Range	-60 to +95	°C
Suitable for Lead-free Soldering - Maximum Soldering Profile	260 °C for 30 s	

Electrical Characteristics

Characteristic	Sym	Notes	Min	Typ	Max	Units
Center Frequency	f_c	1		251.045		MHz
Insertion Loss	IL			13.0	15.0	dB
Amplitude Ripple:		1, 2				dB _{p-p}
($f_c - 6.2500$) to ($f_c - 4.3925$) MHz				0.90	1.75	
($f_c - 4.3925$) to ($f_c - 2.5350$) MHz				0.60	1.50	
($f_c - 2.5350$) to ($f_c - 0.0250$) MHz				0.60	1.50	
($f_c + 0.0250$) to ($f_c + 2.5350$) MHz				0.80	1.50	
($f_c + 2.5350$) to ($f_c + 4.3925$) MHz				0.80	1.75	
($f_c + 4.3925$) to ($f_c + 6.2500$) MHz				0.60	1.75	
1.5 dB Bandwidth Centered at f_c				13.5		MHz
3.0 dB Bandwidth Centered at f_c				14.2		MHz
Low Side Attenuation < ($f_c - 16.5$) MHz			32			dB
Low Side Attenuation, 234.545 to 240.545 MHz ($f_c - 10.5$ MHz)			29			
High Side Attenuation, 260.045 to 267.545 MHz ($f_c + 9.0$ MHz)			18			
High Side Attenuation > ($f_c + 16.5$) MHz			32			
Temperature Coefficient of frequency					-18	ppm/K
Group Delay Ripple:		1, 2, 3				ns _{p-p}
($f_c - 6.2500$) to ($f_c - 4.3925$) MHz				84	150	
($f_c - 4.3925$) to ($f_c - 2.5350$) MHz				35	70	
($f_c - 2.5350$) to ($f_c - 0.0250$) MHz				22	120	
($f_c + 0.0250$) to ($f_c + 2.5350$) MHz				58	120	
($f_c + 2.5350$) to ($f_c + 4.3925$) MHz				37	70	
($f_c + 4.3925$) to ($f_c + 6.2500$) MHz				52	110	
Source/Load Impedance				150		ohms
Case Style		6	SM3838-8 3.8 x 3.8 mm Nominal Footprint			
Lid Symbolization (YY=year, WW=week, S=shift) See note 4			827 YWWS			



CAUTION: Electrostatic Sensitive Device. Observe precautions for handling.

NOTES:

1. Unless noted otherwise, all specifications apply over the operating temperature range with filter soldered to the specified demonstration board with impedance matching to 50 Ω and measured with 50 Ω network analyzer.
2. Unless noted otherwise, all frequency specifications are referenced to the nominal center frequency, f_c .
3. Rejection is measured as attenuation below the minimum IL point in the passband. Rejection in final user application is dependent on PCB layout

4. and external impedance matching design. See Application Note No. 42 for details.
5. The design, manufacturing process, and specifications of this filter are subject to change.
6. Tape and Reel Standard Per ANSI / EIA 481.
7. US and international patents may apply.
8. Murata, stylized Murata logo, and Murata N.A., Inc. are registered trademarks of Murata Manufacturing Co., Ltd..

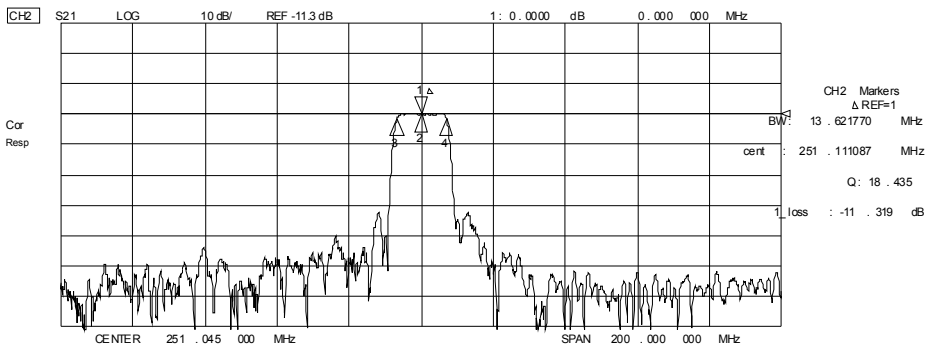
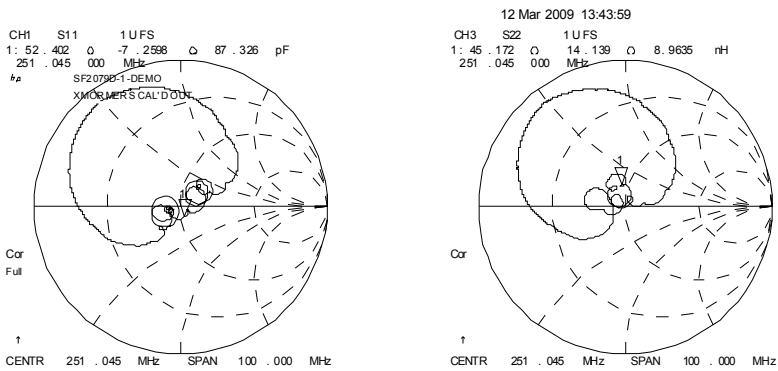
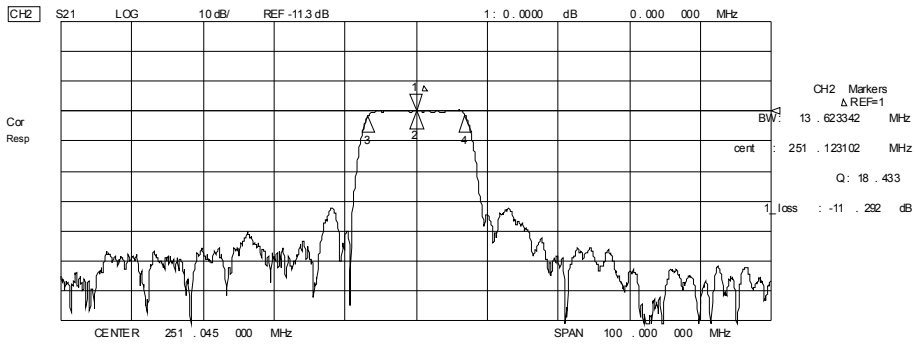
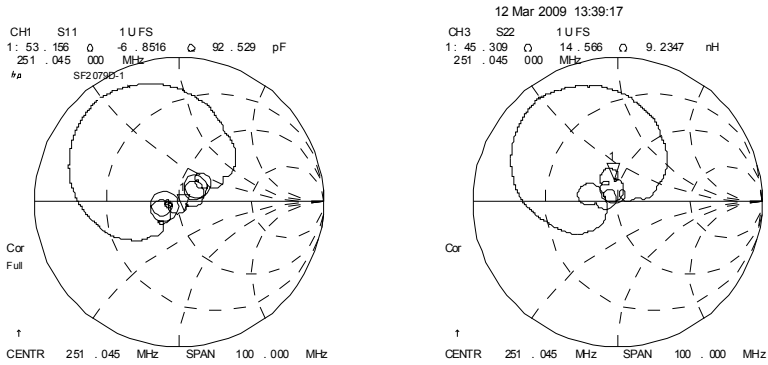

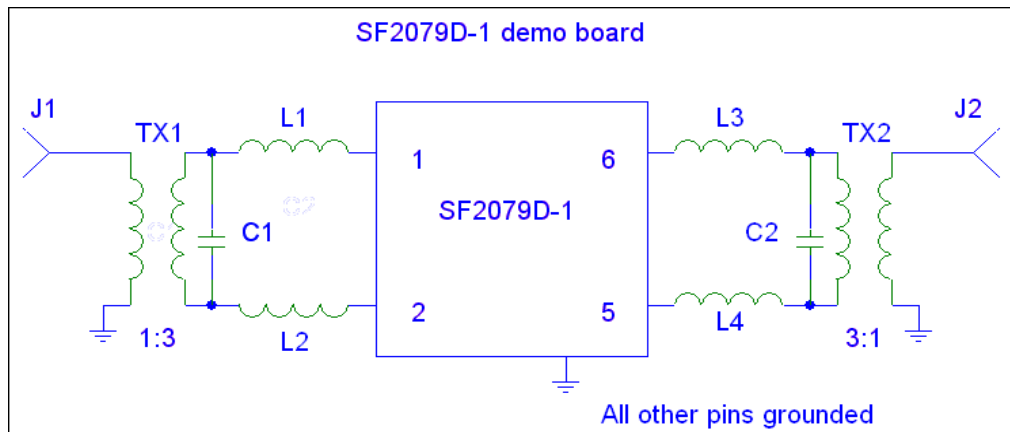
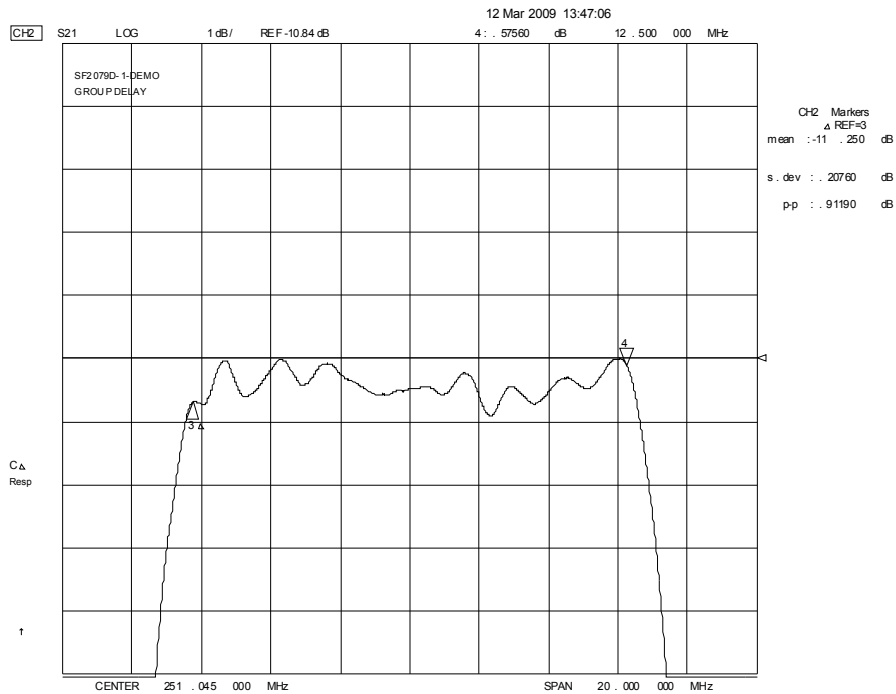

PCB	401-1706-001	
J1, J2	500-0248-002	2-HOLE FLANGE MOUNT SMA CONNECTOR
TX1, TX2	500-0912-003	1:3 TRANSFORMERS SMA
L1, L2	501-1068-430	IND, CHIP, 43nH 0603
L3, L4	501-1068-390	IND, CHIP, 39nH 0603
C1	501-0621-150	CAP, CHIP, 15pF 0603
C2	501-0621-160	CAP, CHIP, 16pF 0603

SM3838-8 Thin Case

8-Terminal Ceramic Surface-Mount Case

3.8 X 3.8 mm Nominal Footprint

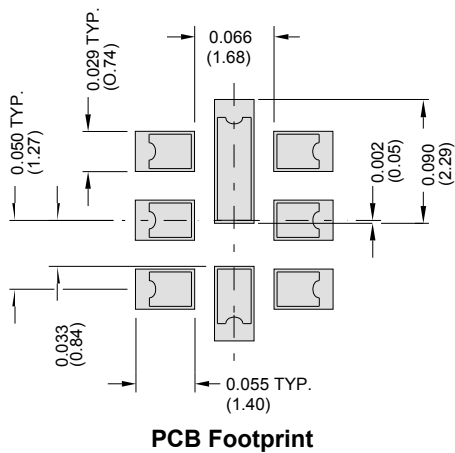

Case Dimensions						
Dimension	mm			Inches		
	Min	Nom	Max	Min	Nom	Max
A	3.6	3.8	4.0	0.142	0.150	0.157
B	3.6	3.8	4.0	0.142	0.150	0.157
C	0.90	1.00	1.1	0.035	0.040	0.043
D	0.80	0.90	1.0	0.031	0.035	0.040
E	0.90	1.00	1.10	0.035	0.040	0.043
F	0.50	0.60	0.70	0.020	0.024	0.028
G	2.39	2.54	2.69	0.090	0.100	0.110
H	1.40	1.75	2.05	0.055	0.069	0.080

Electrical Connections		
	Connection	Terminals
Port 1	Differential Input	1, 2
Port 2	Differential Output	5, 6
	Ground	All Others

Dot Indicates Pin 1

TOP VIEW

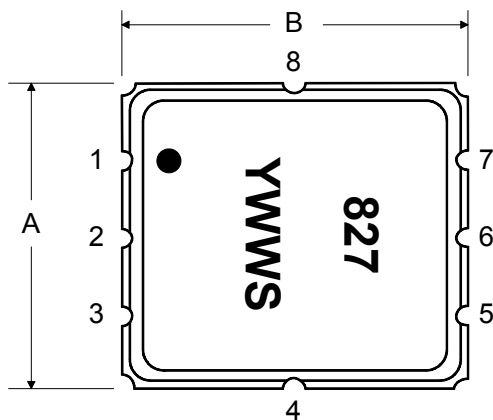

BOTTOM VIEW

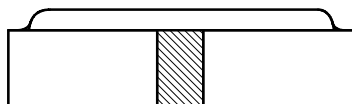
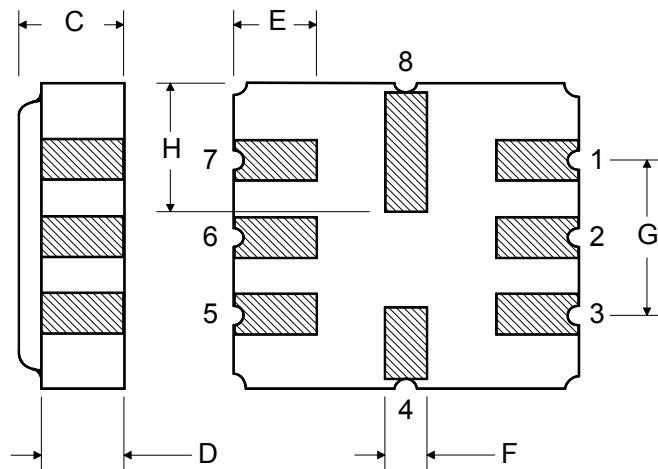

Tape and Reel Specifications

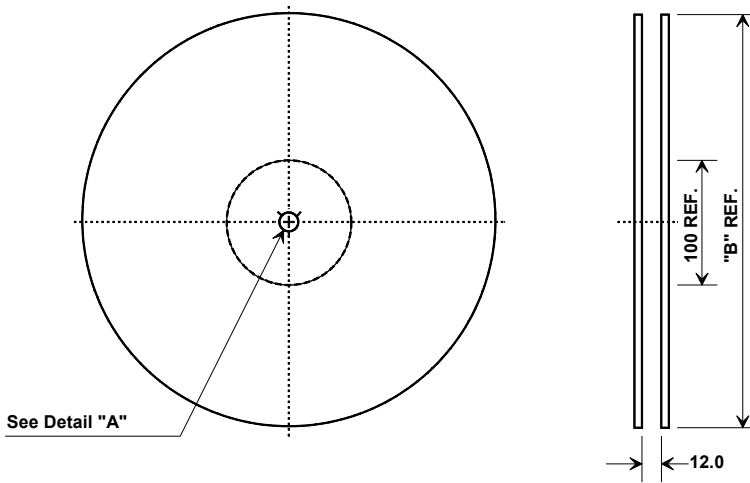

"B"		Quantity Per Reel
Nominal Size		
Inches	millimeters	
7	178	500
13	330	3000

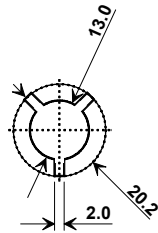

COMPONENT ORIENTATION and DIMENSIONS

Carrier Tape Dimensions	
Ao	4.25 mm
Bo	4.25 mm
Ko	1.30 mm
Pitch	8.0 mm
W	12.0 mm

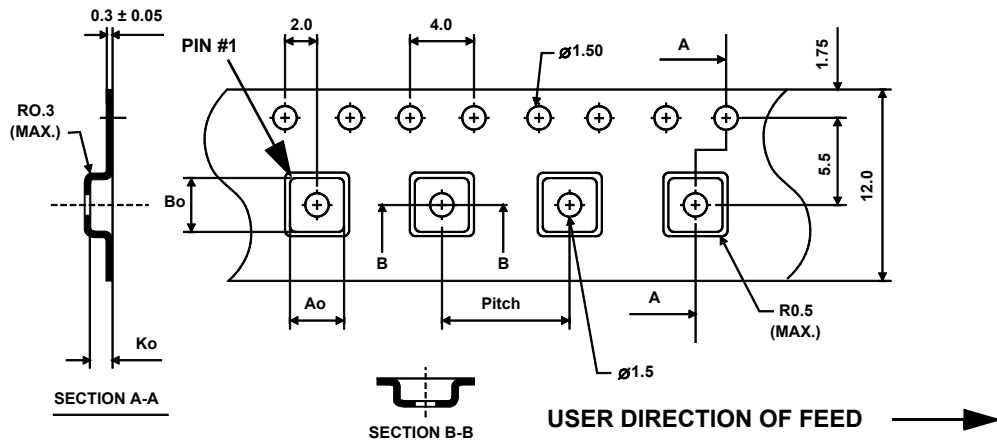

单击下面可查看定价，库存，交付和生命周期等信息

[>>Murata\(村田\)](#)