

Low signal distortion Chip Common Mode Choke Coil for audio

DLM11GN601SD2□ Reference Specification

1.Scope

This reference specification applies to Chip Common Mode Choke Coil DLM11GN601SD2□ Series.

2.Part Numbering

(ex.) DL M 11 G N 601 S D 2 D
 (1) (2) (3) (4) (5) (6) (7) (8) (9) (10)

- | | |
|-------------------------------------|--|
| (1) Chip Common Mode Choke Coil | (6) Impedance (Typ. at 100MHz) |
| (2) Structure (M : Monolithic Type) | (7) Circuit |
| (3) Dimension (L×W) | (8) Features |
| (4) Type | (9) Number of Line |
| (5) Category | (10) Packaging Code D : Taping / B : Bulk |

3.Rating

Customer Part Number	Murata Part Number	Comon Mode Impedance (at 100MHz, Under Standard Testing Conditions)	Rated Voltage	Withstanding Voltage	Rated Current	DC Resistance		Insulation Resistance
						Initial	After Testing	
	DLM11GN601SD2D	600 Ω ±25%	5V(DC)	25V(DC)	100mA	0.8Ω	0.9Ω	100MΩ min.
	DLM11GN601SD2B					max.	max.	

Operating Temperature : -40 to +85°C Storage Temperature : -40 to +85°C

4. Standard Testing Conditions

<Unless otherwise specified>

Temperature : Ordinary Temperature 15 to 35°C
 Humidity : Ordinary Humidity 25 to 85%(RH)

<In case of doubt>

Temperature : 20 ± 2°C
 Humidity : 60 to 70%(RH)
 Atmospheric Pressure : 86 to 106kPa

5.Style and Dimensions

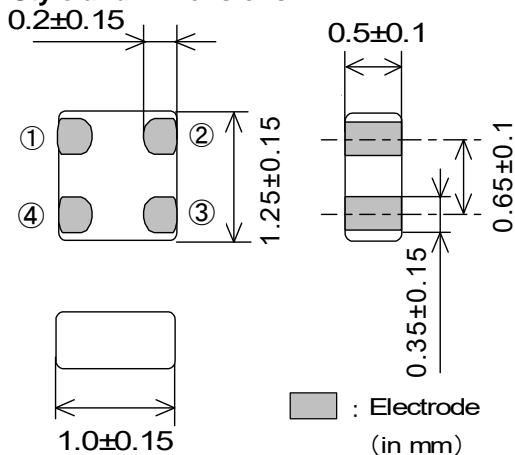

Equivalent Circuits

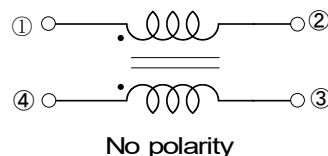

■ Unit mass (Typical value)
0.004g

6.Marking

No Marking.

7.Electrical Performance

No.	Item	Specification	Test Method
7.1	Common Mode Impedance (Zc)	Meet item 3.	Measuring Frequency : 100±1MHz (ref.item 10.) Measuring Equipment : Agilent 4291A or the equivalents Test fixture : Agilent 16193A or the equivalents
7.2	Insulation Resistance (I.R.)		Measuring voltage : Rated Voltage Measuring time : 1 minute max. (ref.item 10.)
7.3	DC Resistance (Rdc)		Measuring current : 10mA max.(ref.item 10.) (In case of doubt in the above mentioned standard condition,measure by 4 terminal method)

No.	Item	Specification	Test Method
7.4	Withstanding Voltage	Products shall not be damaged.	Test Voltage : 25V(DC) Time : 1 to 5 seconds Charge Current : 1 mA max.(ref.item 10.)

8.Mecanical Performance

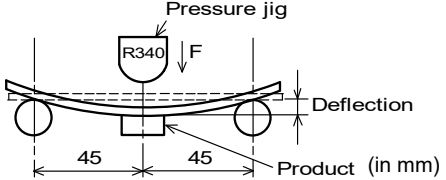
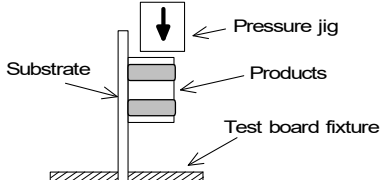
No.	Item	Specification	Test Method								
8.1	Appearance and Dimensions	Meet item 5.	Visual Inspection and measured with Slide Calipers.								
8.2	Solderability	The electrodes shall be at least 95% covered with new solder coating.	Flux : Ethanol solution of rosin,25(wt)% Pre-Heating : 150°C, 1minute Solder : Sn-3.0Ag-0.5Cu Solder Temperature : 245±3°C Immersion Time : 2±1seconds Immersion and emersion rates : 25 mm / s								
8.3	Resistance to Soldering Heat	Meet Table 1. <table border="1" style="width: 100%; border-collapse: collapse; margin-top: 5px;"> <tr> <td style="width: 50%;">Appearance</td> <td>No damaged</td> </tr> <tr> <td>Common Mode Impedance Change</td> <td>within ± 20%</td> </tr> <tr> <td>I.R.</td> <td>100MΩ min.</td> </tr> <tr> <td>DC Resistance</td> <td>Meet item 3.</td> </tr> </table>	Appearance	No damaged	Common Mode Impedance Change	within ± 20%	I.R.	100MΩ min.	DC Resistance	Meet item 3.	Flux : Ethanol solution of rosin,25(wt)% Pre-Heating : 150°C ,1minute Solder : Sn-3.0Ag-0.5Cu Solder Temperature : 270±5°C Immersion Time : 10±0.5 seconds Immersion and emersion rates : 25 mm / s Then measured arter exposure in the room condition for 4 to 48 hours.
Appearance	No damaged										
Common Mode Impedance Change	within ± 20%										
I.R.	100MΩ min.										
DC Resistance	Meet item 3.										
8.4	Bending Strength		Substrate : glass-epoxy(t =1.0 mm) Deflection : 2 mm Speed of Applying Force : 0.5 mm / s Keeping time : 30 seconds 								
8.5	Drop	Products shall be no failure.	It shall be dropped on concrete or steel board. Method : free fall Height : 1m The Number of Times : 3 times								
8.6	Bonding Strength	Meet Table 1.	It shall be soldered on the substrate. Applying Force(F) : 10N Applying Time : 30±1seconds 								
8.7	Vibration		It shall be soldered on the substrate. Oscillation Frequency : 10 to 55 to 10Hz for 1 minute Total Amplitude : 1.5mm Testing Time : A period of 2 hours in each of 3 mutually perpendicular directions. (Total 6 hours)								

9.Environmental Performance (Products shall be soldered on the glass-epoxy substrate)

No.	Item	Specification	Test Method
9.1	Temperature Cycle	Meet Table 1.	1 Cycle Step 1 -40°C(+0°C,-3°C) / 30±3 min Step 2 Ordinary Temp. / 10 to 15 min Step 3 +85(+3°C,-0°C) / 30±3 min Step 4 Ordinary Temp. / 10 to 15 min Total of 100 cycles. Then measured after exposure in the room condition for 4 to 48 hours.
9.2	Humidity		Temperature : 40±2°C Humidity : 90 to 95 % (RH) Time : 1000 hours(+48 hours,-0 hours) Then measured after exposure in the room condition for 4 to 48 hours.
9.3	Heat life		Temperature : 85±2°C Test Voltage : 2 times for Rated Voltage Time : 1000 hours(+48 hours,-0 hours) Then measured after exposure in the room condition for 4 to 48 hours. (ref. Item 10.)
9.4	Cold Resistance		Temperature : -40± 2°C Time : 1000 hours(+48 hours,-0 hours) Then measured after exposure in the room condition for 4 to 48 hours.

10. Terminal to be Tested.

When measuring and suppling the voltage,the following terminal is applied.

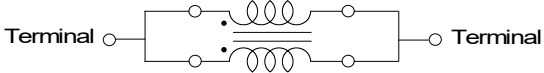
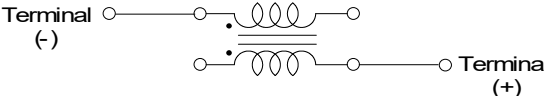
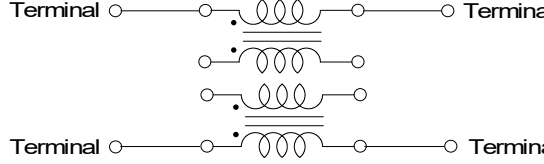
No.	Item	Terminal to be Tested
10.1	Common Mode Impedance (Measurement Terminal)	
10.2	Insulation Resistance (Measurement Terminal)	
10.3	Withstanding Voltage (Measurement Terminal)	
10.4	Heat Life (Supply Terminal)	
10.5	DC Resistance (Measurement Terminal)	

11. Measuring method for common mode impedance.

Measured common mode impedance may be included measurement error due to stray capacitance, residual inductance of test fixture.

To correct this error, the common mode impedance should be calculate as follows;

- (1) Measure admittance of the fixture(opened), G_o B_o .
- (2) Measure impedance of the fixture(shorted), R_s X_s .
- (3) Measure admittance of the specimen, G_m B_m .
- (4) Calculate corrected impedance $|Z|$ using the formula below.

$$|Z| = (R_x^2 + X_x^2)^{1/2}$$

Where

$$R_x = \frac{G_m - G_o}{(G_m - G_o)^2 + (B_m - B_o)^2} - R_s$$

$$X_x = \frac{-(B_m - B_o)}{(G_m - G_o)^2 + (B_m - B_o)^2} - X_s$$

12. P.C.B., Flux, Solder and Soldering condition

Test shall be done using P.C.B., Flux, Solder and Soldering condition which are specified in item 16 except the case of being specified special condition.

13. Impedance Frequency Characteristics(Typical)

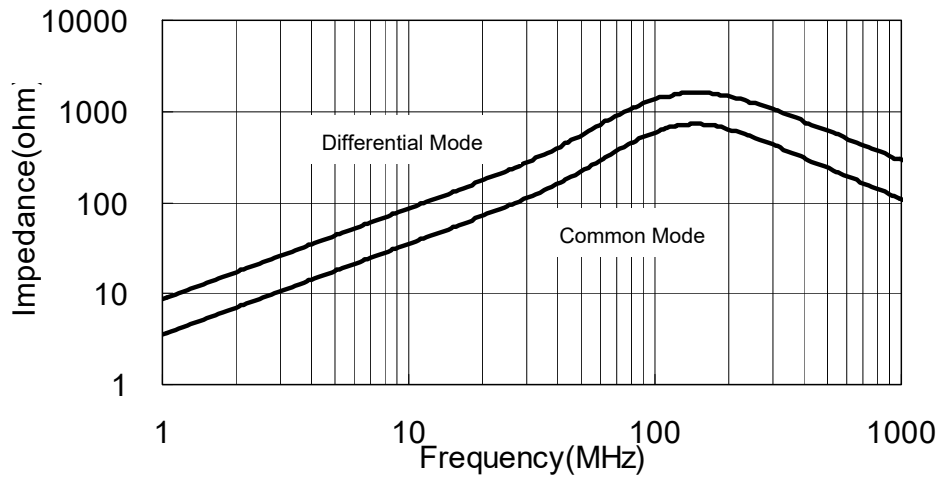

14. Specification of Packaging

14.1 Appearance and Dimensions (8mm width, paper tape)

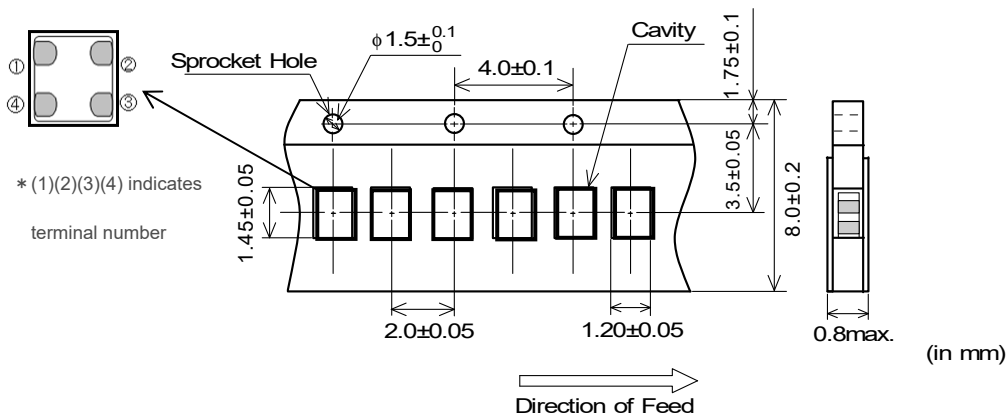

14.2 Specification of Taping

- (1) Packing quantity(Standard quantity) 10000 pcs. / reel
- (2) Packing Method
Products shall be packaged in the cavity of the base tape of 8mm-wide, 2 mm pitch continuously and sealed by top tape and bottom tape.
- (3) Sprocket Hole
The sprocket holes are to the right as the tape is pulled toward the user.
- (4) Spliced point
The base tape and top tape have no spliced point.
- (5) Cavity
There shall not be burr in the cavity.
- (6) Missing components number
Missing components number within 0.025% of the number per reel or 1 pc., whichever is greater, and are not continuous. The specified quantity per reel is kept.

14.3 Pull Strength of Top Tape

Top Tape	5N min.
----------	---------

16. Notice

Products can only be soldered with reflow.
 This product is designed for solder mounting.
 Please consult us in advance for applying other mounting method such as conductive adhesive.

16.1 Flux and Solder

Flux	Use rosin-based flux, but not highly acidic flux (with chlorine content exceeding 0.2(wt)% .) Do not use water-soluble flux.
Solder	Use Sn-3.0Ag-0.5Cu solder Use of Sn-Zn based solder will deteriorate performance of products. In case of using Sn-Zn based solder, please contact Murata in advance.

16.2 Assembling

<Thermal Shock>

Pre-heating should be in such a way that the temperature difference between solder and ceramic surface is limited to 100°C MAX. Also cooling into solvent after soldering should be in such a way that the temperature difference is limited to 100°C max.

16.3 Resin coating

The impedance value may change and/or it may affect on the product's performance due to high cure-stress of resin to be used for coating / molding products. So please pay your careful attention when you select resin. In prior to use, please make the reliability evaluation with the product mounted in your application set.

16.4 Attention regarding P.C.B. bending

The following shall be considered when designing and laying out P.C.B.'s.

(1) P.C.B. shall be designed so that products are not subject to the mechanical stress due to warping the board.

[Products direction]

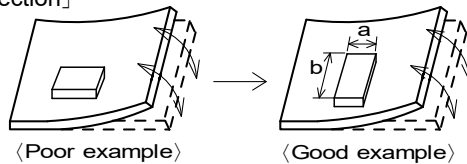

Products shall be location the sideways Direction (Length : $a < b$) to the mechanical Stress.

(2) Products location on P.C.B. separation

Products(A,B,C,D) shall be located carefully so that products are not subject to the mechanical stress due to warping the board. Because they may be subjected the mechanical stress in order of $A > C > B \cong D$.

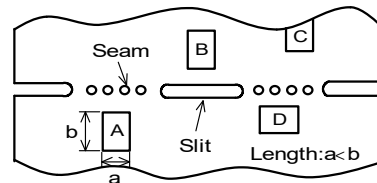

16.5 Attention Regarding P.C.B. Design

< The Arrangement of Products >

P.C.B. shall be designed so that products are far from the portion of perforation.

The portion of perforation shall be designed as narrow as possible, and shall be designed so as not to be applied the stress in the case of P.C.B. separation.

Products shall not be arranged on the line of a series of holes when there are big holes in P.C.B.
 (Because the stress concentrate on the line of holes.)

< Products Placing >

Support pins shall be set under P.C.B. to prevent causing a warp to P.C.B. during placing the products on the other side of P.C.B.

< P.C.B. Separation >

P.C.B. shall not be separated with hand.
 P.C.B. shall be separated with the fixture so as not to cause P.C.B. bending.

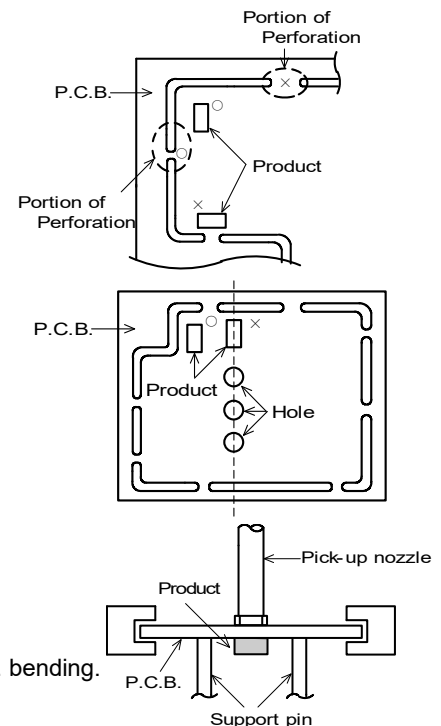

16.6 Standard Land Dimensions (Reflow)

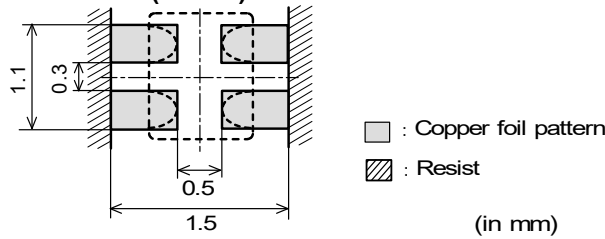

16.7 Soldering

(1) Standard printing pattern of solder paste (Reflow)

- Standard thickness of the solder paste should be 100 to 150 μ m.
- Use the solder paste printing pattern of the right pattern.
- For the resist and copper foil pattern, use standard land dimensions.
- Use the Solder Sn-3.0Ag-0.5Cu for pattern printing.

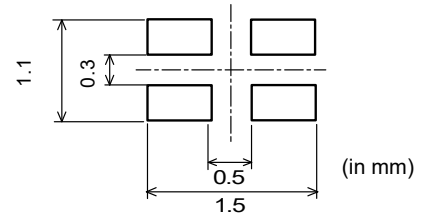

(2) Soldering Conditions

Standard soldering profile and the limit soldering profile is as follows.

The excessive limit soldering conditions may cause leaching of the electrode and / or resulting in the deterioration of product quality.

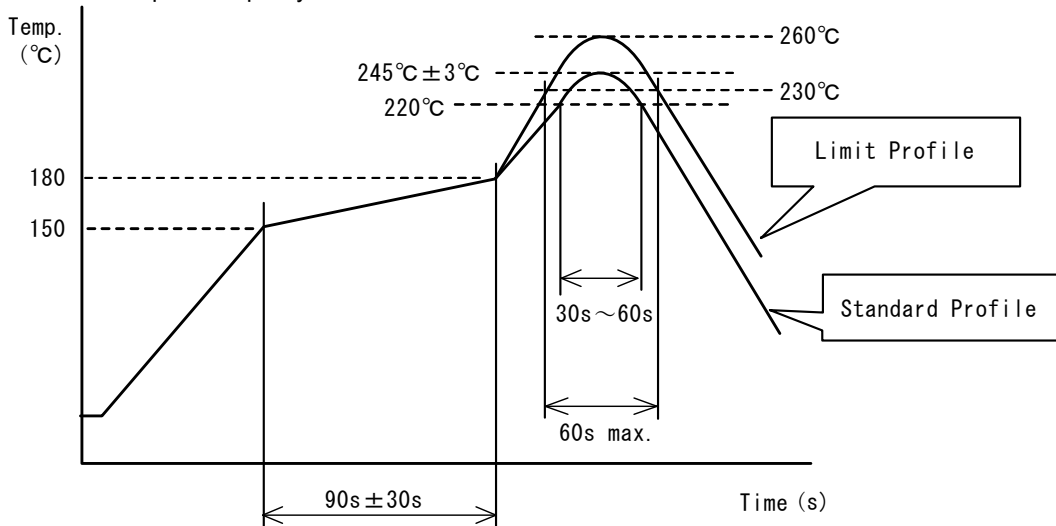

	Standard Profile	Limit Profile
Pre-heating	150~180°C、90s±30s	
Heating	above 220°C、30s~60s	above 230°C、60s max.
Peak temperature	245±3°C	260°C、10s
Cycle of reflow	2 times	2 times

(3) Reworking with Soldering iron

- The following conditions shall be strictly followed when using a soldering iron after being mounted by reflow soldering.
 - Pre-heating: 150°C, 1 min
 - Soldering iron output: 30W max.
 - Tip temperature: 350°C max.
 - Tip diameter: ϕ 3mm max.
 - Soldering time : 3(+1,-0) seconds.
 - Times : 2times max.
- Notes : Do not touch the products directly with the soldering iron.

(3) Solder Volume

Solder shall be used not to be exceeded the upper limits as shown below.

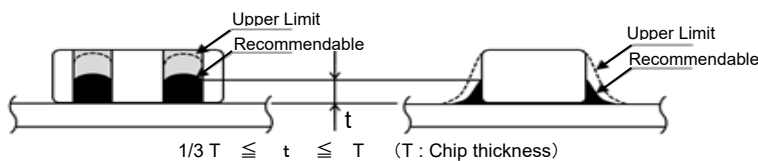

Accordingly increasing the solder volume, the mechanical stress to product is also increased. Excessive solder volume may cause the failure of mechanical or electrical performance.

16.8 Cleaning Conditions

Products shall be cleaned on the following conditions.

- (1) Cleaning temperature shall be limited to 60°C max. (40°C max. for Isopropyl alcohol.)
- (2) Ultrasonic cleaning shall comply with the following conditions, avoiding the resonance phenomenon at the mounted products and P.C.B..
 - Power : 20W/ l max. •Frequency : 28kHz to 40kHz •Time : 5 minutes max.
- (3) Cleaner
 1. alcohol type cleaner • Isopropyl alcohol (IPA)
 2. Aqueous agent • PINE ALPHA ST-100S
- (4) There shall be no residual flux and residual cleaner after cleaning.
In the case of using aqueous agent, products shall be dried completely after rinse with de-ionized water in order to remove the cleaner.
- (5) Other cleaning Please contact us.

16.9 Handling of a substrate

After mounting products on a substrate, do not apply any stress to the product caused by bending or twisting to the substrate when cropping the substrate, inserting and removing a connector from the substrate or tightening screw to the substrate.

Excessive mechanical stress may cause cracking in the product.

Bending

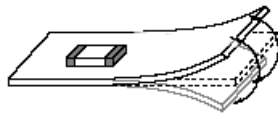

Twisting

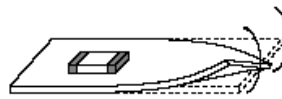

16.10 Operating Environment

Do not use this product under the following environmental conditions, on deterioration of the performance, such as insulation resistance may result from the use.

- (1) in corrosive gases (acidic gases, alkaline gases, chlorine, sulfur gases, organic gases and etc.)
- (2) in the atmosphere where liquid such as organic solvent, may splash on the products.

16.11 Storage Conditions

- (1) Storage period
 - Use the products within 6 months after delivered.
 - Solderability should be checked if this period is exceeded.
- (2) Storage environment condition
 - Products should be stored in the warehouse on the following conditions.
 - Temperature : -10 to +40°C
 - Humidity : 15 to 85% relative humidity
 - No rapid change on temperature and humidity
 - Products should not be stored in corrosive gases, such as sulfurous, acid gases, alkaline gases, to prevent the following deterioration.
 - Poor solderability due to the oxidized electrode.
 - Products should be stored on the palette for the prevention of the influence from humidity, dust and so on.
 - Products should be stored in the warehouse without heat shock, vibration, direct sunlight and so on.
 - Avoid storing the product by itself bare (i.e. exposed directly to air).
- (3) Delivery
 - Care should be taken when transporting or handling product to avoid excessive vibration or mechanical shock.

17. Note

- (1) Please make sure that your product has been evaluated in view of your specifications with our product being mounted to your product.
- (2) You are requested not to use our product deviating from the reference specifications.
- (3) The contents of this reference specification are subject to change without advance notice. Please approve our product specifications or transact the approval sheet for product specifications before ordering.

单击下面可查看定价，库存，交付和生命周期等信息

[>>Murata\(村田\)](#)