

Chip Ferrite Bead BLM31KN□□□SN1□ Reference Specification

1. Scope

This reference specification applies to Chip Ferrite Bead BLM31KN_SN Series.

2. Part Numbering

(ex.) $\frac{BL}{(1)}$ $\frac{M}{(2)}$ $\frac{31}{(3)}$ $\frac{KN}{(4)}$ $\frac{121}{(5)}$ $\frac{S}{(6)}$ $\frac{N}{(7)}$ $\frac{1}{(8)}$ $\frac{L}{(9)}$

(1)Product ID (6)Performance
 (2)Type (7)Category
 (3)Dimension (L×W) (8)Numbers of Circuit
 (4)Characteristics (9)Packaging (L:Taping / B:Bulk)
 (5)Typical Impedance at 100MHz

3. Rating

Customer Part Number	MURATA Part Number	Impedance (Ω) (at 100MHz, Under Standard Testing Condition)	Rated Current (mA) (Note1)		DC Resistance (Ω) max.	
			at 85°C	at 125°C	Initial Values	Values After Testing
	BLM31KN121SN1L BLM31KN121SN1B	120±25%	6000	4000	0.009	0.011
	BLM31KN271SN1L BLM31KN271SN1B	270±25%	4500	3000	0.016	0.019
	BLM31KN471SN1L BLM31KN471SN1B	470±25%	4000	2700	0.02	0.024
	BLM31KN601SN1L BLM31KN601SN1B	600±25%	2900	2000	0.038	0.045
	BLM31KN801SN1L BLM31KN801SN1B	800±25%	2500	1700	0.05	0.06
	BLM31KN102SN1L BLM31KN102SN1B	1000±25%	2000	1400	0.075	0.09

- Operating Temperature: -55°C to +125°C
- Storage Temperature: -55°C to +125°C

(Note1) Rated Current is derated as right figure depending on the operating temperature.

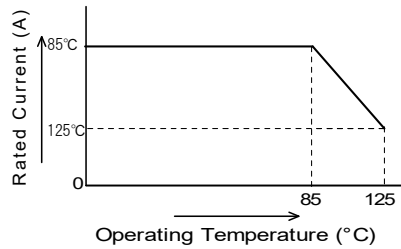

4. Style and Dimensions

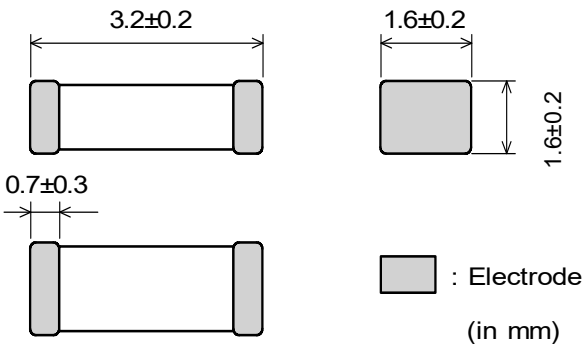

Equivalent Circuit

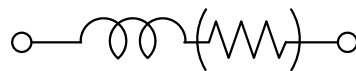

(Resistance element becomes dominant at high frequencies.)

■ Unit Mass (Typical value)
0.041 g

5. Marking

No marking.

6. Standard Testing Conditions

< Unless otherwise specified >

Temperature : Ordinary Temp. (15 °C to 35 °C)

Humidity : Ordinary Humidity (25%(RH) to 85%(RH))

< In case of doubt >

Temperature : 20°C±2 °C

Humidity : 60%(RH) to 70%(RH)

Atmospheric pressure : 86kPa to 106kPa

7. Specifications

7-1. Electrical Performance

No.	Item	Specification	Test Method
7-1-1	Impedance	Meet item 3.	Measuring Frequency : 100MHz±1MHz Measuring Equipment : KEYSIGHT4291A or the equivalent Test Fixture : KEYSIGHT16192A or the equivalent
7-1-2	DC Resistance	Meet item 3.	Measuring Equipment : Digital multi meter *Except resistance of the Substrate and Wire

7-2. Mechanical Performance

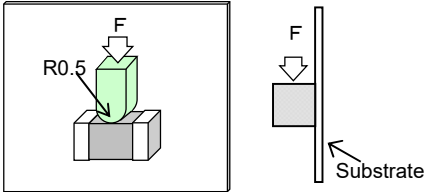
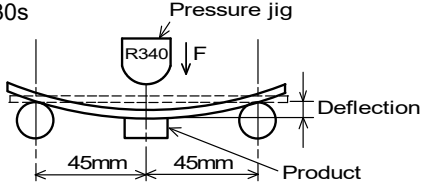
No.	Item	Specification	Test Method						
7-2-1	Appearance and Dimensions	Meet item 4.	Visual Inspection and measured with Slide Calipers.						
7-2-2	Bonding Strength	Meet Table 1. <u>Table 1</u> <table border="1" style="margin-left: 20px;"> <tr> <td>Appearance</td> <td>No damage</td> </tr> <tr> <td>Impedance Change (at 100MHz)</td> <td>Within ±30%</td> </tr> <tr> <td>DC Resistance</td> <td>Meet item 3.</td> </tr> </table>	Appearance	No damage	Impedance Change (at 100MHz)	Within ±30%	DC Resistance	Meet item 3.	It shall be soldered on the substrate. Applying Force(F) : 9.8N Applying Time : 5s±1s Applied direction: Parallel to substrate 
Appearance	No damage								
Impedance Change (at 100MHz)	Within ±30%								
DC Resistance	Meet item 3.								
7-2-3	Bending Strength		It shall be soldered on the substrate. Substrate: Glass-epoxy 100mm×40mm×1.6mm Deflection: 1.0mm Speed of Applying Force : 0.5mm/s Keeping Time : 30s 						

No.	Item	Specification	Test Method								
7-2-4	Vibration	Meet Table 1.	It shall be soldered on the substrate. Oscillation Frequency : 10Hz to 55Hz to 10Hz for 1 min Total Amplitude : 1.5mm Testing Time : A period of 2 hours in each of 3 mutually perpendicular directions. (Total 6 h)								
7-2-5	Resistance to Soldering Heat (Reflow)	Meet Table 2. <table border="1"> <thead> <tr> <th colspan="2">Table 2</th> </tr> </thead> <tbody> <tr> <td>Appearance</td> <td>No damage</td> </tr> <tr> <td>Impedance Change (at 100MHz)</td> <td>Within $\pm 50\%$</td> </tr> <tr> <td>DC Resistance</td> <td>Meet item 3.</td> </tr> </tbody> </table>	Table 2		Appearance	No damage	Impedance Change (at 100MHz)	Within $\pm 50\%$	DC Resistance	Meet item 3.	Solder : Sn-3.0Ag-0.5Cu Pre-Heating : 150°C~180°C, 90±30s Heating : above 220°C , 60±30s Peak temperature: 260°C Cycle of reflow: 2times Then measured after reflow in the room condition for 48h±4h.
Table 2											
Appearance	No damage										
Impedance Change (at 100MHz)	Within $\pm 50\%$										
DC Resistance	Meet item 3.										
7-2-6	Drop	Products shall be no failure after tested.	It shall be dropped on concrete or steel board. Method : free fall Height : 75cm Attitude from which the product is dropped : 3 direction The number of times : 3 times for each direction (Total 9 times)								
7-2-7	Solderability	The electrodes shall be at least 95% covered with new solder coating.	Flux : Ethanol solution of rosin,25(wt)% Pre-Heating : 150°C±10°C, 60s~90s Solder : Sn-3.0Ag-0.5Cu Solder Temperature : 240°C±5°C Immersion Time : 4s±1s Immersion and emersion rates : 25mm/s								

7-3. Environmental Performance

It shall be soldered on the substrate.

No.	Item	Specification	Test Method
7-3-1	Temperature Cycle	Meet Table 2.	1 cycle: 1 step: -55 °C(+0 °C,-3 °C) / 30min±3min 2 step: Ordinary temp. / 10min to 15min 3 step: +125 °C(+3 °C,-0 °C) / 30min±3min 4 step: Ordinary temp. / 10min to 15min Total of 100 cycles Then measured after exposure in the room condition for 48h±4h.
7-3-2	Humidity		Temperature : 40°C±2°C Humidity : 90%(RH) to 95%(RH) Time : 1000h(+48h,-0h) Then measured after exposure in the room condition for 48h±4h.
7-3-3	Heat Life		Temperature : 85°C±3°C Applying Current : Rated Current Time : 1000h(+48h,-0h) Then measured after exposure in the room condition for 48h±4h.
7-3-4	Cold Resistance		Temperature : -55±2°C Time : 1000h(+48h,-0h) Then measured after exposure in the room condition for 48h±4h.

8. Specification of Packaging

8-1. Appearance and Dimensions (8mm-wide plastic tape)

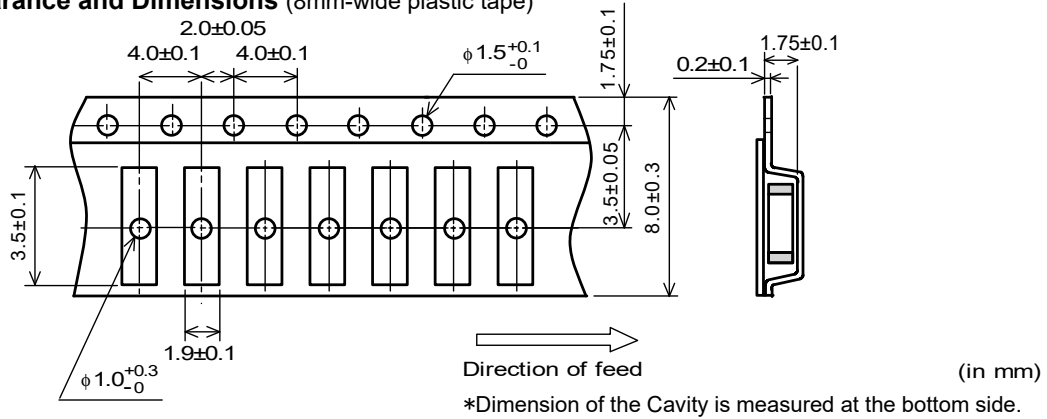

- (1) Taping
Products shall be packaged in the each embossed cavity of 8mm-wide, 4mm-pitch and plastic tape continuously and sealed by cover tape.
- (2) Sprocket hole : The sprocket holes are to the right as the tape is pulled toward the user.
- (3) Spliced point : The cover tape has no spliced point.
- (4) Missing components number
Missing components number within **0.025%** of the number per reel or 1 pc., whichever is greater, and are not continuous. The specified quantity per reel is kept.

8-2. Tape Strength

(1) Pull Strength

Plastic tape	5N min.
Cover tape	10N min.

- (2) Peeling off force of Cover tape
0.2N to 0.7N (Minimum value is typical.)
*Speed of Peeling off:300mm/min

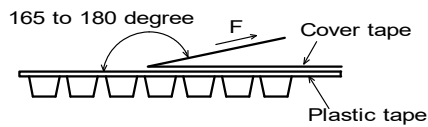

8-3. Taping Condition

- (1) Standard quantity per reel
Quantity per 180mm reel : 2500 pcs. / reel
- (2) There shall be leader-tape (cover tape only and empty tape) and trailer- tape (empty tape) as follows.
- (3) Marking for reel
The following items shall be marked on a label and the label is stuck on the reel.
(Customer part number, MURATA part number, Inspection number (*1), RoHS marking (*2) , Quantity, etc)

*1) « Expression of Inspection No. » □□ OOOO XXXX
 (1) (2) (3)

(1) Factory Code
 (2) Date First digit : Year / Last digit of year
 Second digit : Month / Jan. to Sep. → 1 to 9, Oct. to Dec. → O, N, D
 Third, Fourth digit : Day

(3) Serial No.
 *2) « Expression of RoHS marking » ROHS - Y (Δ)
 (1) (2)

- (1) RoHS regulation conformity parts.
- (2) MURATA classification number
- (4) Outside package
These reels shall be packed in the corrugated cardboard package and the following items shall be marked on a label and the label is stuck on the box.
(Customer name, Purchasing order number, Customer part number, MURATA part number, RoHS marking (*2), Quantity, etc)

(5) Dimensions of reel and taping (leader-tape, trailer-tape)

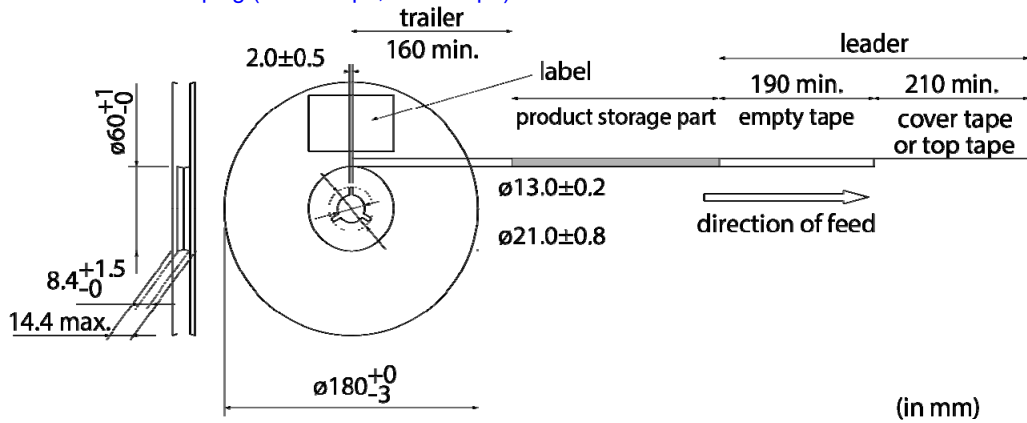

8-4. Specification of Outer Case

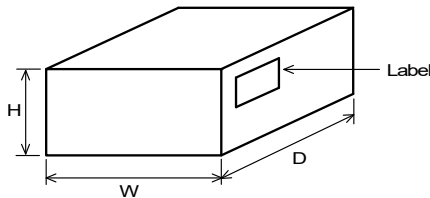

Outer Case Dimensions (mm)			Standard Reel Quantity in Outer Case (Reel)
W	D	H	
186	186	93	5

* Above Outer Case size is typical. It depends on a quantity of an order.

9. ⚠ Caution

9-1. Surge current

Excessive surge current (pulse current or rush current) than specified rated current applied to the product may cause a critical failure, such as an open circuit, burnout caused by excessive temperature rise. Please contact us in advance in case of applying the surge current.

9-2. Limitation of Applications

Please contact us before using our products for the applications listed below which require especially high reliability for the prevention of defects which might directly cause damage to the third party's life, body or property.

- (1) Aircraft equipment
- (2) Aerospace equipment
- (3) Undersea equipment
- (4) Power plant control equipment
- (5) Medical equipment
- (6) Disaster prevention / crime prevention equipment
- (7) Traffic signal equipment
- (8) Transportation equipment (vehicles, trains, ships, etc.)
- (9) Data-processing equipment
- (10) Applications of similar complexity and /or reliability requirements to the applications listed in the above

10. Notice

This product is designed for solder mounting.
Please consult us in advance for applying other mounting method such as conductive adhesive.

10-1. Land pattern designing

- Standard land dimensions (Reflow soldering)

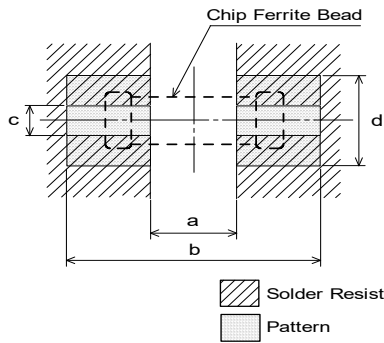

Rated Current (A)	Land pad thickness and dimension d		
	18μm	35μm	70μm
2	1.8	1.8	1.8
2.5~2.9	2.4	1.8	1.8
4~6	6.4	3.3	1.8

(in mm)

*The excessive heat by land pads may cause deterioration at joint of products with substrate.

Type	Soldering	a	b	c
BLM31KN	Reflow	2.0	4.3	1.8

10-2. Soldering Conditions

Products can be applied to reflow soldering.

(1) Flux, Solder

Flux	Use rosin-based flux, but not highly acidic flux (with chlorine content exceeding 0.2(wt)%.) Do not use water-soluble flux.
Solder	Use Sn-3.0Ag-0.5Cu solder Standard thickness of solder paste : 100 μm to 200 μm

(2) Soldering conditions

- Pre-heating should be in such a way that the temperature difference between solder and ferrite surface is limited to 150°C max. Also cooling into solvent after soldering should be in such a way that the temperature difference is limited to 100°C max.
Insufficient pre-heating may cause cracks on the ferrite, resulting in the deterioration of product quality.
- Standard soldering profile and the limit soldering profile is as follows.
The excessive limit soldering conditions may cause leaching of the electrode and / or resulting in the deterioration of product quality.

(3) soldering profile

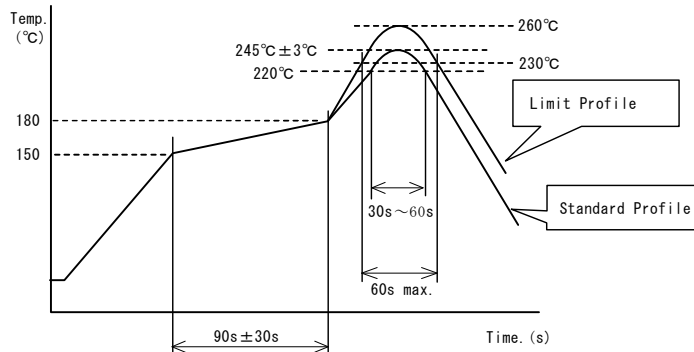

	Standard Profile	Limit Profile
Pre-heating	150~180°C、90s±30s	
Heating	above 220°C、30s~60s	above 230°C、60s max.
Peak temperature	245±3°C	260°C, 10s
Cycle of reflow	2 times	2 times

10-3. Reworking with soldering iron

- Pre-heating: 150°C, 1 min
- Tip temperature: 350°C max.
- Soldering time : 3(+1,-0) seconds.
- Soldering iron output: 80W max.
- Tip diameter: φ 3mm max.
- Times : 2times max.

Note :Do not directly touch the products with the tip of the soldering iron in order to prevent the crack on the ferrite material due to the thermal shock.

10-4. Solder Volume

Solder shall be used not to be exceed as shown below.

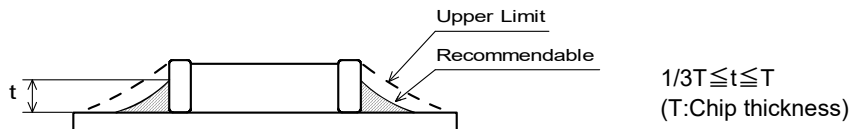

Accordingly increasing the solder volume, the mechanical stress to product is also increased. Exceeding solder volume may cause the failure of mechanical or electrical performance.

10-5. Attention regarding P.C.B. bending

The following shall be considered when designing and laying out P.C.B.'s.

- (1) P.C.B. shall be designed so that products are not subject to the mechanical stress for board warpage.
<Products direction>

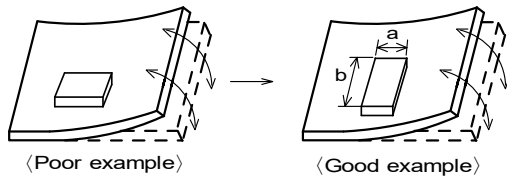

Products shall be located in the sideways direction (Length:a<b) to the mechanical stress.

- (2)Components location on P.C.B. separation.

It is effective to implement the following measures, to reduce stress in separating the board.

It is best to implement all of the following three measures; however, implement as many measures as possible to reduce stress.

Contents of Measures	Stress Level
(1) Turn the mounting direction of the component parallel to the board separation surface.	A > D *1
(2) Add slits in the board separation part.	A > B
(3) Keep the mounting position of the component away from the board separation surface.	A > C

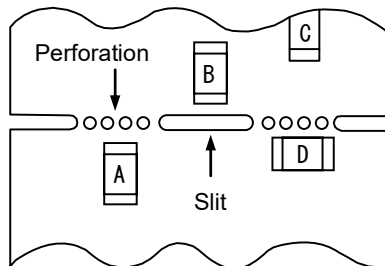

*1 A > D is valid when stress is added vertically to the perforation as with Hand Separation. If a Cutting Disc is used, stress will be diagonal to the PCB, therefore A > D is invalid.

- (3) Mounting Components Near Screw Holes

When a component is mounted near a screw hole, it may be affected by the board deflection that occurs during the tightening of the screw. Mount the component in a position as far away from the screw holes as possible.

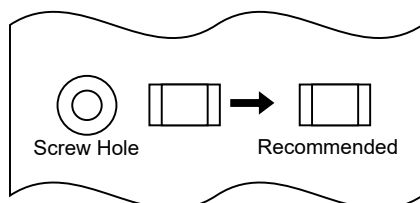

10-6. Mounting density

Add special attention to radiating heat of products when mounting the inductor near the products with heating. The excessive heat by other products may cause deterioration at joint of this product with substrate.

10-7. Operating Environment

Do not use this product under the following environmental conditions, on deterioration of the Insulation Resistance of the Ferrite material and/or corrosion of Inner Electrode may result from the use.

- (1) in the corrodible atmosphere such as acidic gases, alkaline gases, chlorine, sulfur gases, organic gases and etc (the sea breeze, Cl₂, H₂S, NH₃, SO₂, NO₂, etc)
- (2) in the atmosphere where liquid such as organic solvent, may splash on the products.
- (3) in the atmosphere where the temperature / humidity changes rapidly and it is easy to dew.

10-8. Resin coating

The impedance value may change and/or it may affect on the product's performance due to high cure-stress of resin to be used for coating / molding products. So please pay your careful attention when you select resin. In prior to use, please make the reliability evaluation with the product mounted in your application set.

10-9. Cleaning

Excessive ultrasonic oscillation during cleaning can cause the PCBs to resonate, resulting in cracked chips or broken solder joints. Before starting your production process, test your cleaning equipment / process to insure it does not degrade this product.

10-10. Handling of a substrate

After mounting products on a substrate, do not apply any stress to the product caused by bending or twisting to the substrate when cropping the substrate, inserting and removing a connector from the substrate or tightening screw to the substrate.

Excessive mechanical stress may cause cracking in the product.

Bending

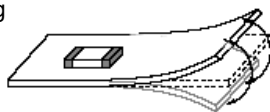

Twisting

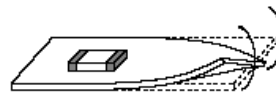
**10-11. Storage Conditions**

(1) Storage period

Use the products within 6 months after delivered.

Solderability should be checked if this period is exceeded.

(2) Storage conditions

- Products should be stored the warehouse on the following conditions.

Temperature : -10°C to 40°C

Humidity : 15% to 85% relative humidity

No rapid change on temperature and humidity

- Don't keep products in corrosive gases such as sulfur, chlorine gas or acid, or it may cause oxidization of electrode, resulting in poor solderability.
- Products should be stored on the palette for the prevention of the influence from humidity, dust and so on.
- Products should be stored in the warehouse without heat shock, vibration, direct sunlight and so on.
- **Avoid storing the product by itself bare (i.e. exposed directly to air).**

(3) Delivery

Care should be taken when transporting or handling product to avoid excessive vibration or mechanical shock.

11. ⚠ Note

(1) Please make sure that your product has been evaluated in view of your specifications with our product being mounted to your product.

(2) You are requested not to use our product deviating from the agreed specifications.

(3) The contents of this reference specification are subject to change without advance notice. Please approve our product specifications or transact the approval sheet for product specifications before ordering.

单击下面可查看定价，库存，交付和生命周期等信息

[>>Murata\(村田\)](#)