

PLA10AS3021R3R2B

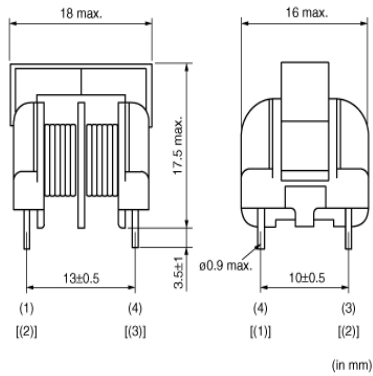

Appearance & Shape



Packaging Information

Packaging	Specifications	Standard Packing Quantity
-	Box	1260

Attention

- 1.This datasheet is downloaded from the website of Murata Manufacturing Co., Ltd. Therefore, it's specifications are subject to change or our products in it may be discontinued without advance notice. Please check with our sales representatives or product engineers before ordering.
- 2.This datasheet has only typical specifications because there is no space for detailed specifications. Therefore, please review our product specifications or consult the approval sheet for product specifications before ordering.

PLA10AS3021R3R2B

Product Data

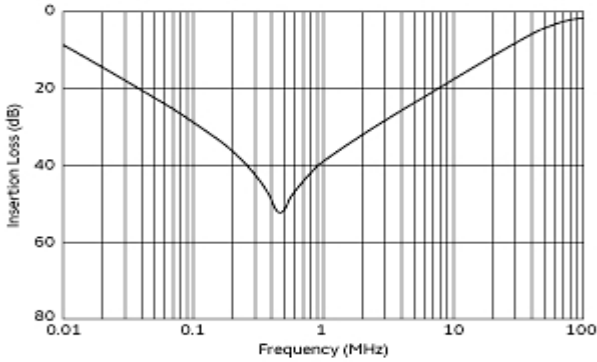

Insertion Loss Characteristics

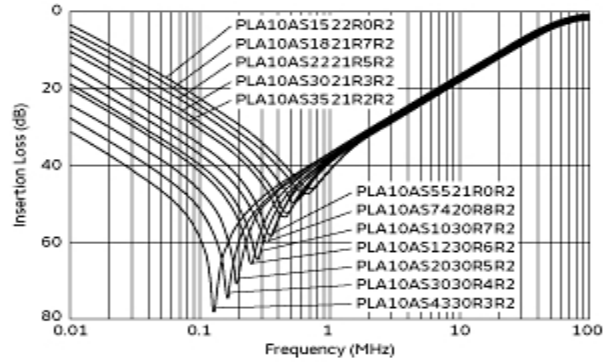

Insertion Loss Characteristics (Main)

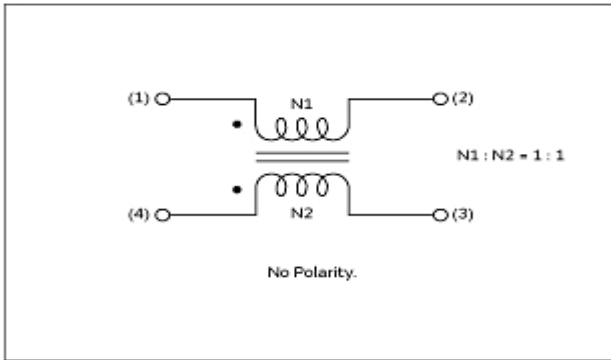

Equivalent Circuit

Attention

- 1.This datasheet is downloaded from the website of Murata Manufacturing Co., Ltd. Therefore, it's specifications are subject to change or our products in it may be discontinued without advance notice. Please check with our sales representatives or product engineers before ordering.
- 2.This datasheet has only typical specifications because there is no space for detailed specifications. Therefore, please review our product specifications or consult the approval sheet for product specifications before ordering.

单击下面可查看定价，库存，交付和生命周期等信息

[>>Murata\(村田\)](#)