

# Reference Only

Spec No.: JEFL243C-9127-01

P1/9

## Wire Wound Chip Common Mode Choke Coil

**DLW32SH□□□XF2□ Murata Standard Reference Specification [AEC-Q200]**

### 1. Scope

This reference specification applies to Wire Wound Chip Common Mode Choke Coil DLW32SH\_XF Series for Automotive Electronics based on AEC-Q200.

### 2. Part Numbering

(ex)	DL	W	32	S	H	101	X	F	2	L
	(1)	(2)	(3)	(4)	(5)	(6)	(7)	(8)	(9)	(10)

- |                                 |                     |
|---------------------------------|---------------------|
| (1) Chip Common Mode Choke Coil | (6) Inductance      |
| (2) Structure (W: Winding Type) | (7) Circuit         |
| (3) Dimension (L×W)             | (8) Features        |
| (4) Type                        | (9) Number of Line  |
| (5) Category                    | (10) Packaging Code |
- L : Taping (Φ 180mm/reel)  
B : Bulk

\*Bulk packing also available. (A product is put in the plastic bag under the taping conditions.)

### 3. Rating

Operating Temperature : -40 to +125°C

Storage Temperature : -40 to +125°C

Customer Part Number	Murata Part Number	Common Mode Inductance (uH) (at 0.1MHz)	Rated Voltage V(DC)	Withstanding Voltage V(DC)	Rated Current (mA)	DC Resistance (Ω max.)	Insulation Resistance (MΩ min.)	ESD Rank
	DLW32SH101XF2L	100 (-30%/+50%)	50	125	115	2.1	10	5B (12kV(AD) < 16kV(AD))

### 4. Standard Testing Condition

<Unless otherwise specified>

Temperature : Ordinary Temperature / 15°C to 35°C  
Humidity : Ordinary Humidity / 25%(RH) to 85%(RH)

<In case of doubt>

Temperature : 20°C±2°C  
Humidity : 60%(RH) to 70%(RH)  
Atmospheric Pressure : 86kPa to 106 kPa

### 5. Style and Dimensions

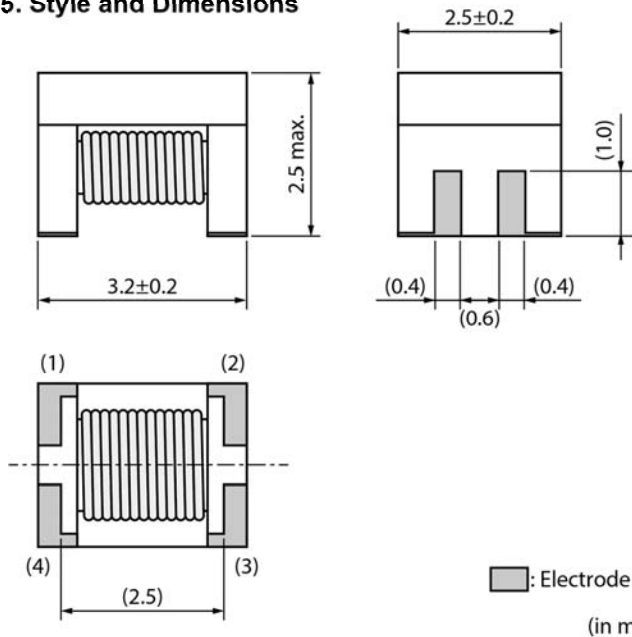

### ■ Equivalent Circuits

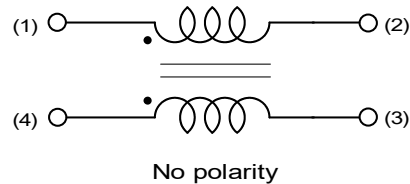

### ■ Unit Mass (Typical value)

0.069g

### 6. Marking

No Marking.

MURATA MFG.CO., LTD

# Reference Only

Spec No.: JEFL243C-9127-01

P2/9

## 7. Electrical Performance

No.	Item	Specification	Test Method
7.1	Common Mode Inductance (Lc)	Meet item 3.	Measuring Equipment : KEYSIGHT 4294A or the equivalent Measuring Frequency:0.1MHz (ref.item 9.1)
7.2	Insulation Resistance (I.R.)	Meet item 3.	Measuring voltage : Rated Voltage Measuring time : 1 min max. (ref.item 9.3)
7.3	Withstanding Voltage	Products shall not be damaged.	Test Voltage : 2.5 times for Rated Voltage Time : 1 to 5 s Charge Current : 1 mA max. (ref.item 9.2)
7.4	DC Resistance (Rdc)	Meet item 3.	Measuring current : 10mA max. (ref.item 9.4) (In case of doubt in the above mentioned standard condition, measure by 4 terminal method.)

## 8.Q200 Requirement

### 8-1.Performance(based on Table 13 for FILTER EMI SUPPRESSORS/FILTERS)

**AEC-Q200 Rev.D issued June 1. 2010**

AEC-Q200			Murata Specification / Deviation				
No.	Stress	Test Method					
3	High Temperature Exposure	1000hours at 125 deg C Set for 24hours at room temperature, then measured.	Meet Table A after testing. Table A <table border="1" style="width: 100%;"> <tr> <td>Appearance</td> <td>No damage</td> </tr> <tr> <td>Common Mode Inductance Change (at 0.1MHz)</td> <td>Within ±20%</td> </tr> </table>	Appearance	No damage	Common Mode Inductance Change (at 0.1MHz)	Within ±20%
Appearance	No damage						
Common Mode Inductance Change (at 0.1MHz)	Within ±20%						
4	Temperature Cycling	1000cycles -40 deg C to +125 deg C Set for 24hours at room temperature, then measured.	Meet Table A after testing.				
5	Destructive Physical Analysis	Per EIA469 No electrical tests	Not Applicable				
7	Biased Humidity	1000hours at 85 deg C, 85%RH Apply max rated current. Set for 24hours at room temperature, then measured.	Meet Table A after testing.  <span style="float: right;">(ref.item 9.5)</span>				
8	Operational Life	1000hours at 125 deg C Apply max rated current Set for 24hours at room temperature, then measured.	Meet Table A after testing.  <span style="float: right;">(ref.item 9.6)</span>				
9	External Visual	Visual inspection	No abnormalities				
10	Physical Dimension	Meet ITEM 5 (Style and Dimensions)	No defects				
12	Resistance to Solvents	Per MIL-STD-202 Method 215	Not Applicable				
13	Mechanical Shock	Per MIL-STD-202 Method 213 Condition F: 1500g's(14.7N)/0.5ms/Half sine	Meet Table A after testing.				
14	Vibration	5g's(0.049N) for 20 minutes, 12cycles each of 3 orientations Test from 10-2000Hz.	Meet Table A after testing.				
15	Resistance to Soldering Heat	No-heating Solder temperature 260C+/-5 deg C Immersion time 10s	Pre-heating:150 to 180 deg C / 90±30s Meet Table A after testing.				

# Reference Only

Spec No.: JEFL243C-9127-01

P3/9

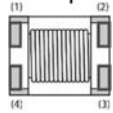
AEC-Q200			Murata Specification / Deviation
No.	Stress	Test Method	
17	ESD	Per AEC-Q200-002	ESD Rank: Meet Item 3 (Rating) Meet Table A after testing.
18	Solderability	Per J-STD-002	Method b : Not Applicable The External electrodes for mounting land patterns shall be at least 95% covered with new solder coating. (Except for Wire) Flux: Ethanol solution of rosin, 25(wt)% includes activator equivalent to 0.06 to 0.10(wt)% chlorine 
19	Electrical Characterization	Measured: Common mode inductance	No defects
20	Flammability	Per UL-94	Not Applicable
21	Board Flex	Epoxy-PCB(1.6mm) Deflection 2mm(min) Holding time 60s	Meet Table A after testing.
22	Terminal Strength	Per AEC-Q200-006 A force of 17.7N for 60s	No defects
30	Electrical Transient Conduction	Per ISO-7637-2	Not Applicable

## 9. Terminal to be Tested.

When measuring and supplying the voltage, the following terminal is applied.

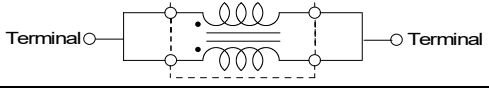
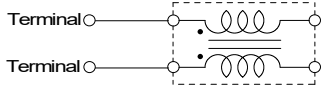
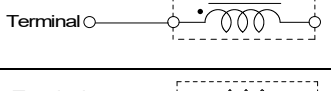
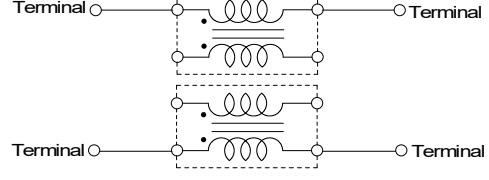
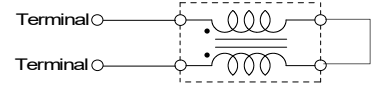
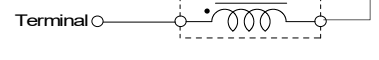
No.	Item	Terminal to be Tested
9.1	Common Mode Inductance (Measurement Terminal)	
9.2	Withstanding Voltage (Measurement Terminal)	
9.3	Insulation Resistance (Measurement Terminal)	
9.4	DC Resistance (Measurement Terminal)	
9.5	Biased Humidity (Supply Terminal)	
9.6	Operational Life (Supply Terminal)	

## 10. P.C.B., Flux, Solder and Soldering condition

Test shall be done using P.C.B., Flux, Solder and Soldering condition which are specified in item 13 except the case of being specified special condition.

## 11. Specification of Packaging

### 11.1 Appearance and Dimensions ( 12mm-wide,Plastic tape)

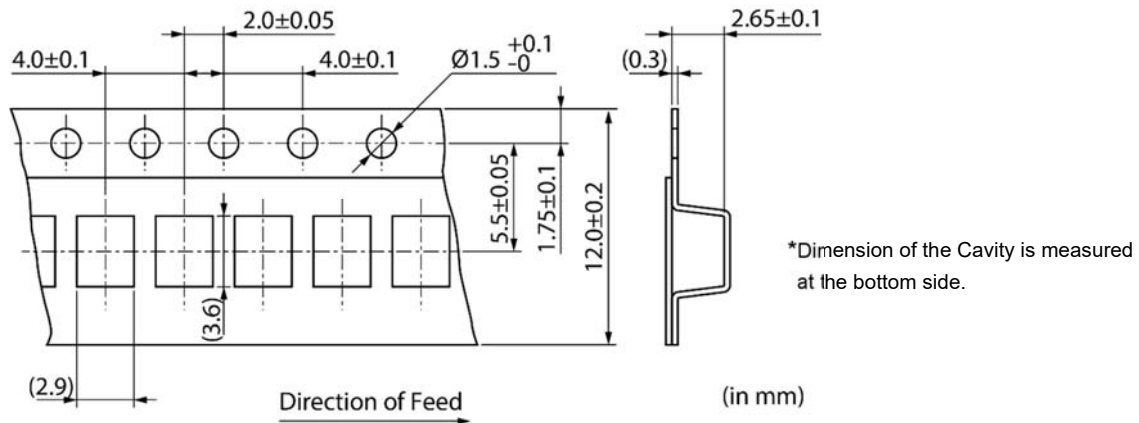

### 11.2. Specification of Taping

- (1) Packing quantity (Standard quantity)  $\varnothing$  180 mm reel :1500 pcs. / reel
- (2) Packing Method  
Products shall be packaged in each embossed cavity of plastic tape and sealed with cover tape.
- (3) Sprocket Hole  
The sprocket holes are to the right as the tape is pulled toward the user.
- (4) Spliced point  
The cover tape have no spliced point.
- (5) Missing components number  
Missing components number within 0.1% of the number per reel or 1 pc., whichever is greater, and are not continuous. The specified quantity per reel is kept.

### 11.3. Pull Strength of Plastic Tape

Plastic Tape	5 N min.
Cover Tape	10 N min.

### 11.4. Peeling off force of Cover Tape

0.2N to 0.7N (minimum value is typical.)  
Speed of Peeling off : 300 mm / min

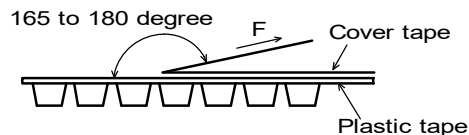

### 11.5. Dimensions of Leader-tape, Trailer and Reel

There shall be leader-tape (cover tape only and empty tape) and trailer-tape (empty tape) as follows.

« Packaging Code : L (  $\varnothing$  180mm reel ) »

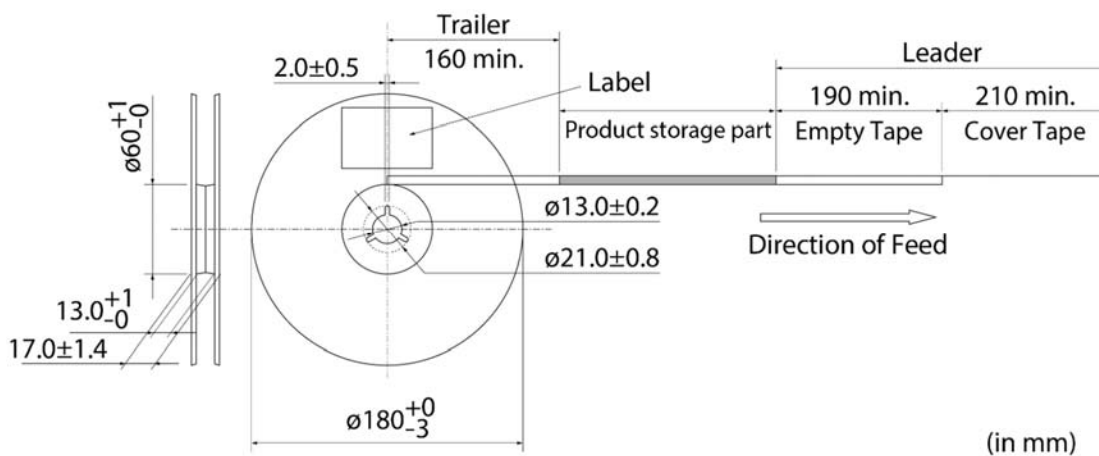

# Reference Only

Spec No.: JEFL243C-9127-01

P5/9

## 11.6 Marking for reel

Customer part number, MURATA part number, Inspection number(\*1), RoHS Marking(\*2), Quantity, etc

\*1) « Expression of Inspection No. »

$\frac{\square\square}{(1)}$      $\frac{0000}{(2)}$      $\frac{\times\times\times}{(3)}$

- (1) Factory Code
- (2) Date

First digit : Year / Last digit of year  
 Second digit : Month / Jan. to Sep. → 1 to 9, Oct. to Dec. → O, N, D  
 Third, Fourth digit : Day

- (3) Serial No.

\*2) « Expression of RoHS Marking »

ROHS -  $\frac{Y(\Delta)}{(1)(2)}$

- (1) RoHS regulation conformity parts.
- (2) MURATA classification number

## 11.7 Marking for Outside package

Customer name Purchasing Order Number, Customer Part Number, MURATA part number, RoHS Marking(\*2), Quantity, etc

## 11.8 Specification of Outer Case

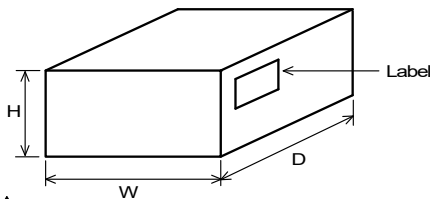

Reel	Outer Case Dimensions (mm)			Standard Reel Quantity in Outer Case (Reel)
	W	D	H	
φ 180mm	186	186	93	4

\*Above Outer Case size is typical. It depends on a quantity of an order.

## 12. ⚠ Caution

### 12.1 Mounting Direction

Mount products in right direction.

Wrong direction which is 90° rotated from right direction causes not only open or short circuit but also flames or other serious trouble.

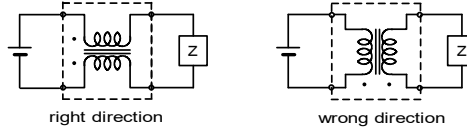

### 12.2 Limitation of Applications

Please contact us before using our products for the applications listed below which require especially high reliability for the prevention of defects which might directly cause damage to the third party's life, body or property.

- |                                   |  |
|-----------------------------------|--|
| (1) Aircraft equipment            | (6) Transportation equipment (trains, ships, etc.)   |
| (2) Aerospace equipment           | (7) Traffic signal equipment   |
| (3) Undersea equipment            | (8) Disaster prevention / crime prevention equipment   |
| (4) Power plant control equipment | (9) Data-processing equipment  |
| (5) Medical equipment             | (10) Applications of similar complexity and /or reliability requirements to the applications listed in the above |

### 12.3 Caution(Rating)

Do not exceed maximum rated current of the product. Thermal stress may be transmitted to the product and short/open circuit of the product or falling off the product may be occurred.

### 12.4 Fail-safe

Be sure to provide an appropriate fail-safe function on your product to prevent a second damage that may be caused by the abnormal function or the failure of our product.

## 13. Notice

Products can only be soldered with reflow.

This product is designed for solder mounting.

Please consult us in advance for applying other mounting method such as conductive adhesive.

### 13.1 Flux and Solder

Flux	Use rosin-based flux, (with converting chlorine content 0.06 to 0.1(wt)% .), but not highly acidic flux (with Halogen content exceeding 0.2(wt)% conversion to chlorine). Do not use water-soluble flux.
Solder	Use Sn-3.0Ag-0.5Cu solder Standard thickness of the solder paste should be 150μm.

### 13.2 Assembling

<Exclusive use of Reflow soldering>

Flow soldering may cause deterioration in insulation resistance.  
So, reflow soldering shall be applied for this product.

### 13.3 Cleaning Conditions

Do not clean after soldering. Some cleaning agents may degrade bonding strength, and characteristics of products by detaching. If cleaning, please contact us.

### 13.4 Resin coating

The inductance value may change due to high cure-stress of resin to be used for coating/molding products. An open circuit issue may occur by mechanical stress caused by the resin, amount/cured shape of resin, or operating condition etc. Some resin contains some impurities or chloride possible to generate chlorine by hydrolysis under some operating condition may cause corrosion of wire of coil, leading to open circuit. So, please pay your careful attention when you select resin in case of coating/molding the products with the resin. Prior to use the coating resin, please make sure no reliability issue is observed by evaluating products mounted on your board.

### 13.5 Attention regarding P.C.B. bending

The following shall be considered when designing and laying out P.C.B.'s.

(1) P.C.B. shall be designed so that products are not subject to the mechanical stress due to warping the board.

[Products direction]

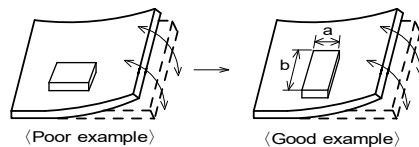

Products shall be location the sideways  
Direction (Length :  $a < b$ ) to the mechanical Stress.

(2) Components location on P.C.B. separation.

It is effective to implement the following measures, to reduce stress in separating the board.

It is best to implement all of the following three measures; however, implement as many measures as possible to reduce stress.

Contents of Measures	Stress Level
(1) Turn the mounting direction of the component parallel to the board separation surface.	$A > D$ *1
(2) Add slits in the board separation part.	$A > B$
(3) Keep the mounting position of the component away from the board separation surface.	$A > C$

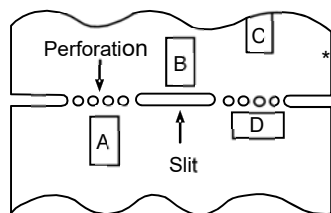

\*1  $A > D$  is valid when stress is added vertically to the perforation as with Hand Separation.  
If a Cutting Disc is used, stress will be diagonal to the PCB, therefore  $A > D$  is invalid.

(3) Mounting Components Near Screw Holes

When a component is mounted near a screw hole, it may be affected by the board deflection that occurs during the tightening of the screw. Mount the component in a position as far away from the screw holes as possible.

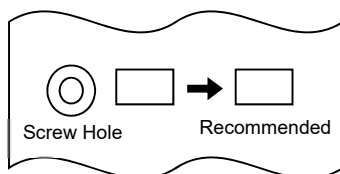

### 13.6 Attention Regarding P.C.B. Design

#### < The Arrangement of Products >

P.C.B. shall be designed so that products are far from the portion of perforation.

The portion of perforation shall be designed as narrow as possible, and shall be designed so as not to be applied the stress in the case of P.C.B. separation.

Products shall not be arranged on the line of a series of holes when there are big holes in P.C.B. (Because the stress concentrate on the line of holes.)

#### < Products Placing >

Support pins shall be set under P.C.B. to prevent causing a warp to P.C.B. during placing the products on the other side of P.C.B.

#### < P.C.B. Separation >

P.C.B. shall not be separated with hand.  
P.C.B. shall be separated with the fixture so as not to cause P.C.B. bending.

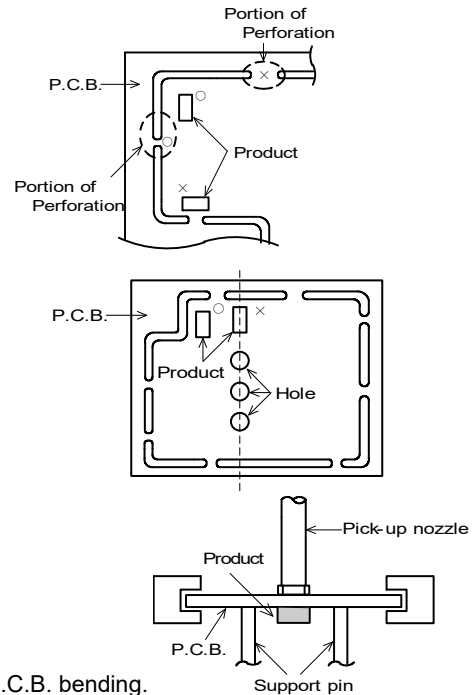

### 13.7 Standard Land Dimensions (Reflow)

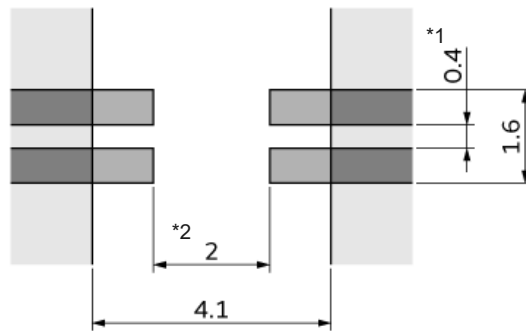

(in mm)

- \*1 If the pattern is made with less than 0.4mm, in the worst case, short circuit between lines may be occurred due to the spread of soldering paste or mount placing accuracy.
- \*2 If the pattern is made with wider, the strength of bending will be reduced. Moreover, if the pattern is made with less than 2mm, in the worst case short circuit may be occurred.
- \*3 Do not use gilded pattern. A copper wire may cause open by dissolution of metallization.

### 13.8 Standard Soldering Condition

#### 1.Reflow Soldering

##### (1) Standard printing pattern of solder paste

- Standard thickness of the solder paste should be 150 μm.
- Use the solder paste printing pattern of the right pattern.
- For the resist and copper foil pattern, use standard land dimensions.
- Use the Solder Sn-3.0Ag-0.5Cu for pattern printing.
- Spread of soldering paste between lines may cause short circuit of lines.

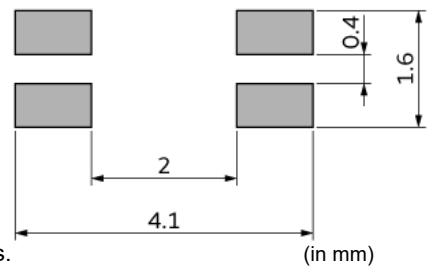

(in mm)

(2) Soldering Temperature

Temperature difference between soldering and surface of components must be within 150°C, in preheating. When components are immersed in liquid after soldering, temperature difference should be within 100°C. If preheating is not enough, components may be cracked and cause deterioration in insulation resistance.

(3) Soldering Condition

Standard soldering profile and the limit soldering profile is as follows.

The excessive limit soldering conditions may cause leaching of the electrode and / or resulting in the deterioration of product quality.

Soldering Profile for Lead Free solder (Sn-3.0Ag-0.5Cu solder )

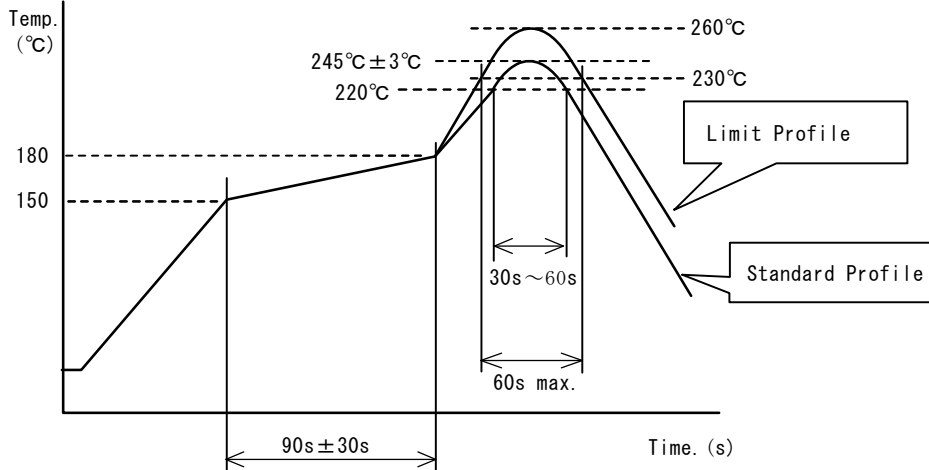

	Standard Profile	Limit Profile
Pre-heating	150~180°C、90s±30s	
Heating	above 220°C、30s~60s	above 230°C、60s max.
Peak temperature	245±3°C	260°C,10s
Cycle of reflow	2 times	2 times

2. Reworking with Soldering iron

The following conditions must be strictly followed when using a soldering iron after being mounted by reflow soldering.

- Pre-heating: 150°C, 1 min
- Tip temperature: 350°C max.
- Soldering time : 3(+1,-0) s.
- Soldering iron output: 30W max.
- Tip diameter: φ3mm max.
- Times : 2times max.

Notes : Do not touch the products directly with the soldering iron.

3. Solder Volume

Solder shall be used not to be exceeded the upper limits as shown below.

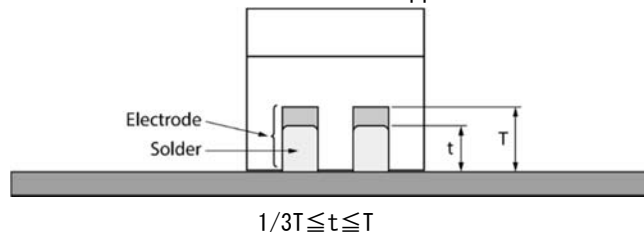

Accordingly increasing the solder volume, the mechanical stress to Chip is also increased. Exceeding solder volume may cause the failure of mechanical or electrical performance. In case if the solder volume is much, we recommend to make the size of the solder paste with less than the land pattern.

4. Solder fillet

Solder fillet in lateral direction is not formed in some case because of product's structure, but it is not something that affects product's performance and reliability.



### 13.9 Caution for use

- When you hold products with a tweezer, please hold like a figure of the right side, and sharp material, such as a pair of tweezers, shall not be touched to the winding portion to prevent the breaking of wire.
- Mechanical shock should not be applied to the products mounted on the board to prevent the breaking of the core.

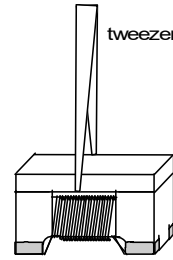

### 13.10 Handling of a substrate

After mounting products on a substrate, do not apply any stress to the product caused by bending or twisting to the substrate when cropping the substrate, inserting and removing a connector from the substrate or tightening screw to the substrate.  
Excessive mechanical stress may cause cracking in the product.

Bending

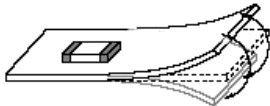

Twisting

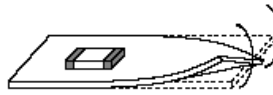

### 13.11 Brushing of neighborhood of products

When you clean the neighborhood of products such as connector pins, bristles of cleaning brush shall not be touched to the winding portion to prevent the breaking of wire.

### 13.12 Mounting Conditions

- Please check the mounting condition before using.
- Using mounting conditions (nozzles, equipment conditions, etc.) that are not suitable for products may lead to pick up errors, misalignment, or damage to the product.

### 13.13 Operating Environment

Do not use this product under the following environmental conditions, on deterioration of the performance, such as insulation resistance may result from the use.

- (1) in corrosive gases (acidic gases, alkaline gases, chlorine, sulfur gases, organic gases and etc.)
- (2) in the atmosphere where liquid such as organic solvent, may splash on the products.

### 13.14 Storage Condition

#### (1) Storage period

Use the products within 12 months after delivered.

Solderability should be checked if this period is exceeded.

#### (2) Storage environment conditions

- Products should be stored in the warehouse on the following conditions.

Temperature : -10 ~ +40°C

Humidity : 15 to 85% relative humidity No rapid change on temperature and humidity.

- Products should not be stored in corrosive gases, such as sulfurous, acid gases, alkaline gases, to prevent the following deterioration.

Poor solderability due to the oxidized electrode.

- Products should be stored on the palette for the prevention of the influence from humidity, dust and so on.
- Products should be stored in the warehouse without heat shock, vibration, direct sunlight and so on.
- Products should not be stored under the air tight packaged condition.

#### (3) Delivery

Care should be taken when transporting or handling product to avoid excessive vibration or mechanical shock.

## 14. Note

- (1) Please make sure that your product has been evaluated in view of your specifications with our product being mounted to your product.
- (2) You are requested not to use our product deviating from the reference specifications.
- (3) The contents of this reference specification are subject to change without advance notice. Please approve our product specifications or transact the approval sheet for product specifications before ordering.

单击下面可查看定价，库存，交付和生命周期等信息

[>>Murata\(村田\)](#)