

# Reference Only

## CHIP COIL (CHIP INDUCTORS) LQP03TQ□□□□02D Reference Specification

### 1.Scope

This reference specification applies to LQP03TQ series, Chip coil (Chip Inductors).

### 2.Part Numbering

(ex)   LQ     P     03     T     Q     0N6     W     0     2     D    
 Product ID Structure Dimension Applications Category Inductance Tolerance Features Electrode Packaging  
 (L × W) and Characteristics  
 \*B: Bulk

\*Bulk packing also available. (A product is put in the plastic bag under the taping conditions.)

### 3.Rating

- Operating Temperature.            -55°C to +125°C
- Storage Temperature.            -55°C to +125°C

Customer Part Number	MURATA Part Number	Inductance		Q (min)	DC Resistance (Ω max)	Self Resonant Frequency (MHz)		Rated Current (mA)			
		(nH)	Tolerance			Min.	*Typ.				
	LQP03TQ0N6W02D	0.6	W:±0.05nH B:±0.1nH C:±0.2nH	17	0.05	20000	>20000	1000			
	LQP03TQ0N6B02D										
	LQP03TQ0N6C02D										
	LQP03TQ0N7W02D										
	LQP03TQ0N7B02D										
	LQP03TQ0N7C02D										
	LQP03TQ0N8W02D	0.7			W:±0.05nH B:±0.1nH C:±0.2nH	17		0.05	18000	>20000	1000
	LQP03TQ0N8B02D										
	LQP03TQ0N8C02D										
	LQP03TQ0N9W02D										
	LQP03TQ0N9B02D										
	LQP03TQ0N9C02D										
	LQP03TQ1N0W02D	0.8	W:±0.05nH B:±0.1nH C:±0.2nH	17			0.08	17000	>20000		800
	LQP03TQ1N0B02D										
	LQP03TQ1N0C02D										
	LQP03TQ1N1W02D										
	LQP03TQ1N1B02D										
	LQP03TQ1N1C02D										
	LQP03TQ1N2W02D	0.9			W:±0.05nH B:±0.1nH C:±0.2nH	17	0.08	17000		>20000	800
	LQP03TQ1N2B02D										
	LQP03TQ1N2C02D										
	LQP03TQ1N3W02D										
	LQP03TQ1N3B02D										
	LQP03TQ1N3C02D										
	LQP03TQ1N4W02D	1.0	W:±0.05nH B:±0.1nH C:±0.2nH	17			0.10	16000	>20000		700
	LQP03TQ1N4B02D										
	LQP03TQ1N4C02D										
	LQP03TQ1N5W02D										
	LQP03TQ1N5B02D										
	LQP03TQ1N5C02D										
	LQP03TQ1N6W02D	1.1			W:±0.05nH B:±0.1nH C:±0.2nH	17	0.10	15000		>20000	650
	LQP03TQ1N6B02D										
	LQP03TQ1N6C02D										
	LQP03TQ1N7W02D										
	LQP03TQ1N7B02D										
	LQP03TQ1N7C02D										
	LQP03TQ1N8W02D	1.2	W:±0.05nH B:±0.1nH C:±0.2nH	17			0.10	15000	>20000		650
	LQP03TQ1N8B02D										
	LQP03TQ1N8C02D										
	LQP03TQ1N9W02D										
	LQP03TQ1N9B02D										
	LQP03TQ1N9C02D										
	LQP03TQ2N0B02D	1.3			W:±0.05nH B:±0.1nH C:±0.2nH	17	0.10	12500		>20000	650
	LQP03TQ2N0C02D										
	LQP03TQ2N1B02D										
	LQP03TQ2N1C02D										
	LQP03TQ2N2B02D										
	LQP03TQ2N2C02D										
	LQP03TQ2N0B02D	1.4	W:±0.05nH B:±0.1nH C:±0.2nH	17			0.12	11000	>20000		650
	LQP03TQ2N0C02D										
	LQP03TQ2N1B02D										
	LQP03TQ2N1C02D										
	LQP03TQ2N2B02D										
	LQP03TQ2N2C02D										
	LQP03TQ2N0B02D	1.5			W:±0.05nH B:±0.1nH C:±0.2nH	17	0.12	11000		>20000	650
	LQP03TQ2N0C02D										
	LQP03TQ2N1B02D										
	LQP03TQ2N1C02D										
	LQP03TQ2N2B02D										
	LQP03TQ2N2C02D										
	LQP03TQ2N0B02D	1.6	W:±0.05nH B:±0.1nH C:±0.2nH	17			0.12	11000	>20000		650
	LQP03TQ2N0C02D										
	LQP03TQ2N1B02D										
	LQP03TQ2N1C02D										
	LQP03TQ2N2B02D										
	LQP03TQ2N2C02D										
	LQP03TQ2N0B02D	1.7			W:±0.05nH B:±0.1nH C:±0.2nH	17	0.12	11000		>20000	650
	LQP03TQ2N0C02D										
	LQP03TQ2N1B02D										
	LQP03TQ2N1C02D										
	LQP03TQ2N2B02D										
	LQP03TQ2N2C02D										
	LQP03TQ2N0B02D	1.8	W:±0.05nH B:±0.1nH C:±0.2nH	17			0.12	11000	>20000		650
	LQP03TQ2N0C02D										
	LQP03TQ2N1B02D										
	LQP03TQ2N1C02D										
	LQP03TQ2N2B02D										
	LQP03TQ2N2C02D										
	LQP03TQ2N0B02D	1.9			W:±0.05nH B:±0.1nH C:±0.2nH	17	0.12	11000		>20000	650
	LQP03TQ2N0C02D										
	LQP03TQ2N1B02D										
	LQP03TQ2N1C02D										
	LQP03TQ2N2B02D										
	LQP03TQ2N2C02D										
	LQP03TQ2N0B02D	2.0	W:±0.05nH B:±0.1nH C:±0.2nH	17			0.12	11000	>20000		650
	LQP03TQ2N0C02D										
	LQP03TQ2N1B02D										
	LQP03TQ2N1C02D										
	LQP03TQ2N2B02D										
	LQP03TQ2N2C02D										
	LQP03TQ2N0B02D	2.1			W:±0.05nH B:±0.1nH C:±0.2nH	17	0.12	11000		>20000	650
	LQP03TQ2N0C02D										
	LQP03TQ2N1B02D										
	LQP03TQ2N1C02D										
	LQP03TQ2N2B02D										
	LQP03TQ2N2C02D										
	LQP03TQ2N0B02D	2.2	W:±0.05nH B:±0.1nH C:±0.2nH	17			0.12	11000	>20000		650
	LQP03TQ2N0C02D										
	LQP03TQ2N1B02D										
	LQP03TQ2N1C02D										
	LQP03TQ2N2B02D										
	LQP03TQ2N2C02D										

# Reference Only

Spec No. JELF243C-0024B-01

P.2/12

Customer Part Number	MURATA Part Number	Inductance		Q (min)	DC Resistance (Ω max)	Self Resonant Frequency (MHz)		Rated Current (mA)
		(nH)	Tolerance			Min.	*Typ.	
	LQP03TQ2N3B02D	2.3	B:±0.1nH C:±0.2nH	17	0.15	11000	12600	550
	LQP03TQ2N3C02D							
	LQP03TQ2N4B02D	2.4						
	LQP03TQ2N4C02D							
	LQP03TQ2N5B02D	2.5				10000	12300	
	LQP03TQ2N5C02D							
	LQP03TQ2N6B02D	2.6			12100			
	LQP03TQ2N6C02D							
	LQP03TQ2N7B02D	2.7			12800			
	LQP03TQ2N7C02D							
	LQP03TQ2N8B02D	2.8	0.20	12300	500			
	LQP03TQ2N8C02D							
	LQP03TQ2N9B02D	2.9		12400				
	LQP03TQ2N9C02D							
	LQP03TQ3N0B02D	3.0		12100				
	LQP03TQ3N0C02D							
	LQP03TQ3N1B02D	3.1	0.24	11800	450			
	LQP03TQ3N1C02D							
	LQP03TQ3N2B02D	3.2		9500		11400		
	LQP03TQ3N2C02D							
	LQP03TQ3N3B02D	3.3		11200				
	LQP03TQ3N3C02D							
	LQP03TQ3N4B02D	3.4	0.25	10100	400			
	LQP03TQ3N4C02D							
	LQP03TQ3N5B02D	3.5		8000		9900		
	LQP03TQ3N5C02D							
	LQP03TQ3N6B02D	3.6		9800		9700		
	LQP03TQ3N6C02D							
	LQP03TQ3N7B02D	3.7	10500	10100	360			
	LQP03TQ3N7C02D							
	LQP03TQ3N8B02D	3.8	6500	10000				
	LQP03TQ3N8C02D							
	LQP03TQ3N9B02D	3.9	9900	8400	350			
	LQP03TQ3N9C02D							
	LQP03TQ4N0B02D	4.0	6000	8800	300			
	LQP03TQ4N0C02D							
	LQP03TQ4N1B02D	4.1	8300	7900	250			
	LQP03TQ4N1C02D							
	LQP03TQ4N2B02D	4.2	5400	7600				
	LQP03TQ4N2C02D							
	LQP03TQ4N3H02D	4.3	4800	7100				
	LQP03TQ4N3J02D							
	LQP03TQ4N7H02D	4.7	0.65	6600	250			
	LQP03TQ4N7J02D							
	LQP03TQ5N1H02D	5.1	4500	6300				
	LQP03TQ5N1J02D							
	LQP03TQ5N6H02D	5.6	0.55	5400	300			
	LQP03TQ5N6J02D							
	LQP03TQ6N2H02D	6.2	4800	7900				
	LQP03TQ6N2J02D							
	LQP03TQ6N8H02D	6.8	0.65	7600	250			
	LQP03TQ6N8J02D							
	LQP03TQ7N5H02D	7.5	4800	7100				
	LQP03TQ7N5J02D							
	LQP03TQ8N2H02D	8.2	0.65	6600	250			
	LQP03TQ8N2J02D							
	LQP03TQ9N1H02D	9.1	4500	6300				
	LQP03TQ9N1J02D							
	LQP03TQ10NH02D	10	0.69	6300				
	LQP03TQ10NJ02D							

MURATA MFG.CO.,LTD

# Reference Only

Spec No. JELF243C-0024B-01

P.3/12

Customer Part Number	MURATA Part Number	Inductance		Q (min)	DC Resistance ( $\Omega$ max)	Self Resonant Frequency (MHz)		Rated Current (mA)
		(nH)	Tolerance			Min.	*Typ.	
	LQP03TQ11NH02D	11		17	0.69	3700	5600	250
	LQP03TQ11NJ02D						4900	
	LQP03TQ12NH02D	12		17	0.69	3700	4800	250
	LQP03TQ12NJ02D						4900	
	LQP03TQ13NH02D	13		17	0.69	3700	4800	250
	LQP03TQ13NJ02D						4900	
	LQP03TQ15NH02D	15		17	0.8	3500	5100	250
	LQP03TQ15NJ02D						4800	
	LQP03TQ16NH02D	16		14	1.1	3500	4800	200
	LQP03TQ16NJ02D						4500	
	LQP03TQ18NH02D	18		14	1.2	3000	4100	200
	LQP03TQ18NJ02D						4500	
	LQP03TQ20NH02D	20		14	1.2	3000	4100	200
	LQP03TQ20NJ02D						4500	
	LQP03TQ22NH02D	22		14	1.6	2000	3800	150
	LQP03TQ22NJ02D						3800	
	LQP03TQ24NH02D	24		14	1.6	2000	3800	150
	LQP03TQ24NJ02D						3800	
	LQP03TQ27NH02D	27		14	1.6	2000	3800	150
	LQP03TQ27NJ02D						3800	
	LQP03TQ30NH02D	30		11	2.0	1700	3400	130
	LQP03TQ30NJ02D						3200	
	LQP03TQ33NH02D	33		11	2.5	1500	3000	130
	LQP03TQ33NJ02D						2900	
	LQP03TQ36NH02D	36		11	2.5	1500	3000	130
	LQP03TQ36NJ02D						2900	
	LQP03TQ39NH02D	39		11	4.0	1300	2800	130
	LQP03TQ39NJ02D						2700	
	LQP03TQ43NH02D	43		11	4.0	1300	2800	130
	LQP03TQ43NJ02D						2700	
	LQP03TQ47NH02D	47		11	4.0	1300	2700	130
	LQP03TQ47NJ02D						2700	
	LQP03TQ51NH02D	51		9	6.0	1200	2600	100
	LQP03TQ51NJ02D						2500	
	LQP03TQ56NH02D	56		9	6.0	1200	2600	100
	LQP03TQ56NJ02D						2500	
	LQP03TQ62NH02D	62		9	7.0	1100	2300	80
	LQP03TQ62NJ02D						2100	
	LQP03TQ68NH02D	68		9	7.0	1100	2100	80
	LQP03TQ68NJ02D						2000	
	LQP03TQ75NH02D	75		9	7.0	1100	2000	80
	LQP03TQ75NJ02D						2000	
	LQP03TQ82NH02D	82		9	8.0	1000	1800	70
	LQP03TQ82NJ02D						1800	
	LQP03TQ91NH02D	91		9	8.0	1000	1800	70
	LQP03TQ91NJ02D						1800	
	LQP03TQR10H02D	100		9	9.0	900	1700	70
	LQP03TQR10J02D						1700	
	LQP03TQR11H02D	110		9	9.0	900	1600	70
	LQP03TQR11J02D						1600	

H:±3%  
J:±5%

\* Typical value is actual performance.

#### 4. Testing Conditions

《Unless otherwise specified》

Temperature : Ordinary Temperature / 15°C to 35°C  
Humidity : Ordinary Humidity / 25%(RH) to 85 %(RH)

《In case of doubt》

Temperature : 20°C ± 2°C  
Humidity : 60%(RH) to 70 %(RH)  
Atmospheric Pressure : 86kPa to 106 kPa

MURATA MFG.CO.,LTD

# Reference Only

## 5. Appearance and Dimensions

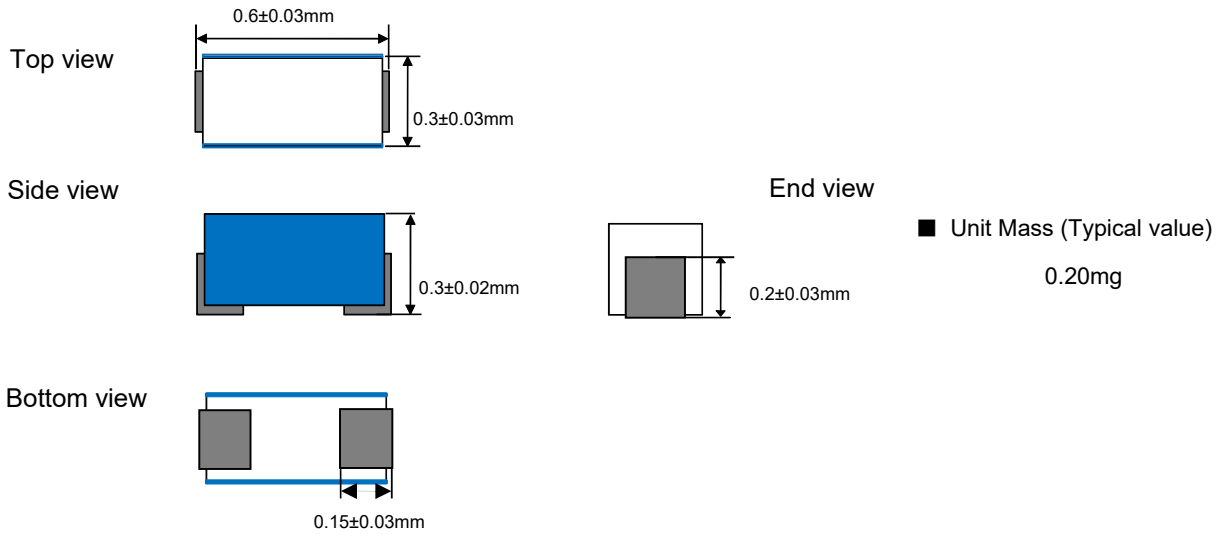

## 6. Marking

Side surface identification marking :Blue

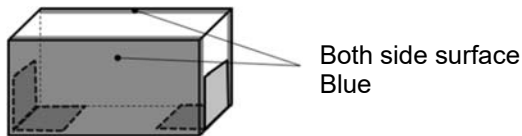

## 7. Electrical Performance

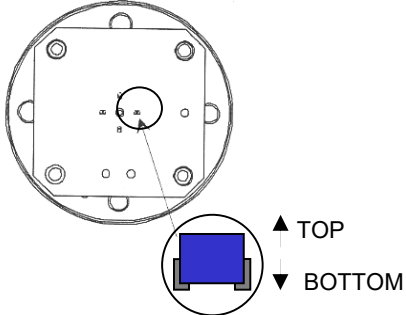
No.	Item	Specification	Test Method
7.1	Inductance	Inductance shall meet item 3.	<p>Measuring Equipment: KEYSIGHT E4991A or equivalent Measuring Frequency: (0.6~30nH)500MHz (33~110nH) 300MHz</p> <p>Measuring Condition: Test signal level / about 0dBm Electrical length / 10mm Weight / about 1N~5N</p> <p>Measuring Fixture: KEYSIGHT 16197A Position coil under test as shown in below and contact coil with each terminal by adding weight. Bottom side should be a bottom, and should be in the direction of the fixture for position of chip coil.</p>  <p>Measuring Method: See the endnote. &lt;Electrical Performance: Measuring Method of Inductance/Q&gt;</p>
7.2	Q	Q shall meet item 3.	

# Reference Only

No.	Item	Specification	Test Method
7.3	DC Resistance	DC Resistance shall meet item 3.	Measuring Equipment: Digital multi meter
7.4	Self Resonant Frequency(S.R.F)	S.R.F shall meet item 3.	Measuring Equipment: KEYSIGHT N5230A or equivalent
7.5	Rated Current	Self temperature rise shall be limited to 25°C max.	The rated current is applied.

## 8. Mechanical Performance

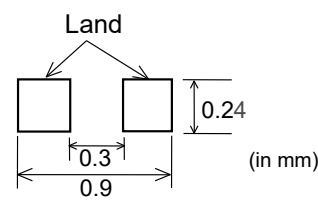
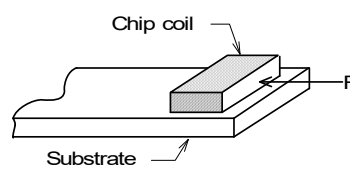
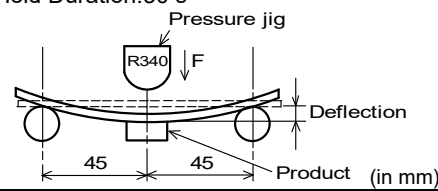
No.	Item	Specification	Test Method
8.1	Shear Test	Chip coil shall not be damaged after tested as test method.	<p>Substrate: Glass-epoxy substrate</p>  <p style="text-align: right;">(in mm)</p> <p>Force: 2N Hold Duration: 5 s ± 1 s Applied Direction: Parallel to PCB</p> 
8.2	Bending Test		<p>Substrate: Glass-epoxy substrate (100mm × 40mm × 0.8mm)</p> <p>Speed of Applying Force: 1mm / s Deflection: 1mm Hold Duration: 30 s</p>  <p style="text-align: right;">Product (in mm)</p>
8.3	Vibration	Appearance: No damage Inductance Change: within ±10%	<p>Substrate: Glass-epoxy substrate</p> <p>Oscillation Frequency: 10Hz to 2000Hz to 10Hz for 20 min</p> <p>Total amplitude 1.5 mm or Acceleration amplitude 196 m/s<sup>2</sup> whichever is smaller.</p> <p>Testing Time: A period of 2h in each of 3 mutually perpendicular directions.</p>
8.4	Solderability	The electrode shall be at least 90% covered with new solder coating.	<p>Flux: Ethanol solution of rosin 25(wt)% (Immersed for 5s to 10s)</p> <p>Solder: Sn-3.0Ag-0.5Cu</p> <p>Pre-Heating: 150°C ± 10°C / 60s to 90s</p> <p>Solder Temperature: 240°C ± 5°C</p> <p>Immersion Time: 3s ± 1s</p>
8.5	Resistance to Soldering Heat	Appearance: No damage Inductance Change: within ±10%	<p>Flux: Ethanol solution of rosin 25(wt)% (Immersed for 5s to 10s)</p> <p>Solder: Sn-3.0Ag-0.5Cu</p> <p>Pre-Heating: 150°C ± 10°C / 60s to 90s</p> <p>Solder Temperature: 260°C ± 5°C</p> <p>Immersion Time: 5s ± 1s</p> <p>Then measured after exposure in the room condition for 24h ± 2h.</p>

# Reference Only

## 9.Environmental Performance

It shall be soldered on the substrate.

No.	Item	Specification	Test Method
9.1	Heat Resistance	Appearance:No damage Inductance Change: within $\pm 10\%$	Substrate: Glass-epoxy substrate Temperature: $125^{\circ}\text{C} \pm 2^{\circ}\text{C}$ Time: 1000h (+48h, -0h) Then measured after exposure in the room condition for 24h $\pm$ 2h.
9.2	Cold Resistance		Substrate: Glass-epoxy substrate Temperature: $-55^{\circ}\text{C} \pm 3^{\circ}\text{C}$ Time: 1000 h (+48h, -0h) Then measured after exposure in the room condition for 24h $\pm$ 2h.
9.3	Humidity		Substrate: Glass-epoxy substrate Temperature: $40^{\circ}\text{C} \pm 2^{\circ}\text{C}$ Humidity: 90%(RH) to 95%(RH) Time: 1000 h(+48h, -0h) Then measured after exposure in the room condition for 24h $\pm$ 2h.
9.4	Temperature Cycle		Substrate: Glass-epoxy substrate 1 cycle: 1 step: $-55^{\circ}\text{C} \pm 2^{\circ}\text{C}$ / 30min $\pm$ 3 min 2 step: Ordinary temp. / 10~15 min 3 step: $125^{\circ}\text{C} \pm 2^{\circ}\text{C}$ / 30 $\pm$ 3 min 4 step: Ordinary temp. / 10~15 min Total of 10 cycles Then measured after exposure in the room condition for 24h $\pm$ 2h.

## 10.Specification of Packaging

### 10.1 Appearance and Dimensions of paper tape (8mm-wide)

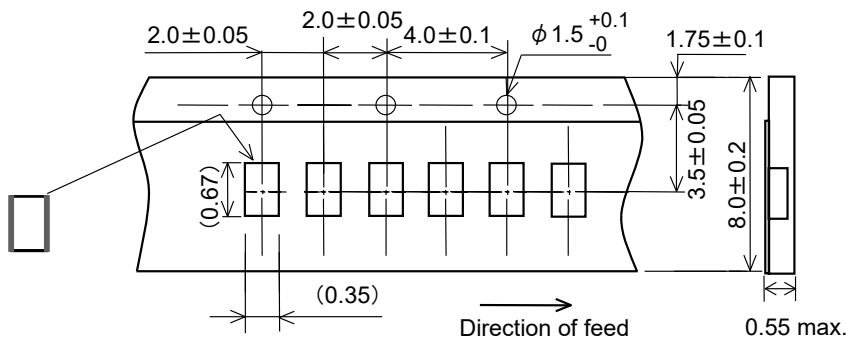

(in mm)

### 10.2 Specification of Taping

- (1) Packing quantity (standard quantity)  
15,000 pcs. / reel
- (2) Packing Method  
Products shall be packed in the cavity of the base tape and sealed by cover tape.
- (3) Sprocket hole  
The sprocket holes are to the right as the tape is pulled toward the user.
- (4) Spliced point  
Base tape and Cover tape has no spliced point.

# Reference Only

(5) Missing components number

Missing components number within 0.1 % of the number per reel or 1 pc. , whichever is greater, and are not continuous. The Specified quantity per reel is kept.

**10.3 Pull Strength**

Cover tape	5N min
------------	--------

**10.4 Peeling off force of cover tape**

Speed of Peeling off	300mm/min
Peeling off force	0.1N to 0.6N (minimum value is typical)

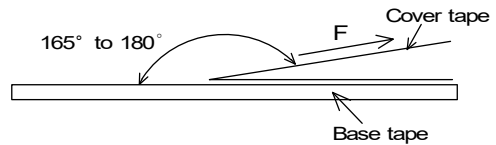

**10.5 Dimensions of Leader-tape, Trailer and Reel**

There shall be leader-tape ( top tape and empty tape) and trailer-tape (empty tape) as follows.

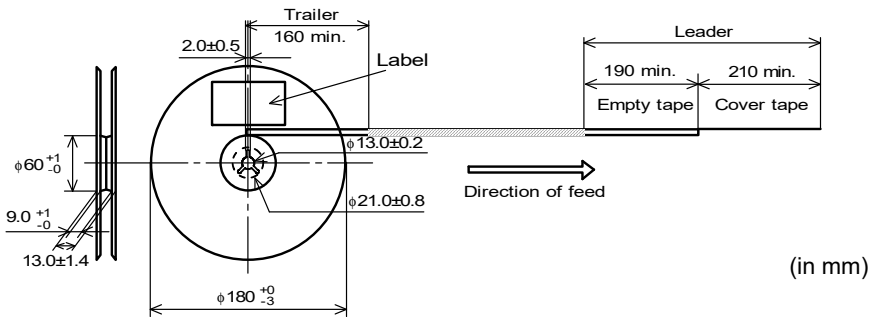

**10.6 Marking for reel**

Customer part number, MURATA part number, Inspection number(\*1), RoHS Marking(\*2), Quantity etc ...

\*1) <Expression of Inspection No.>

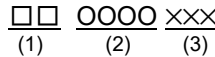

- (1) Factory Code
- (2) Date

First digit : Year / Last digit of year  
 Second digit : Month / Jan. to Sep. → 1 to 9, Oct. to Dec. → O,N,D  
 Third, Fourth digit : Day

- (3) Serial No.

\*2) <Expression of RoHS Marking >

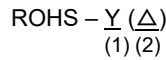

- (1) RoHS regulation conformity parts.
- (2) MURATA classification number

**10.7 Marking for Outside package (corrugated paper box)**

Customer name, Purchasing order number, Customer part number, MURATA part number, RoHS Marking (\*2), Quantity, etc ...

**10.8 Specification of Outer Case**

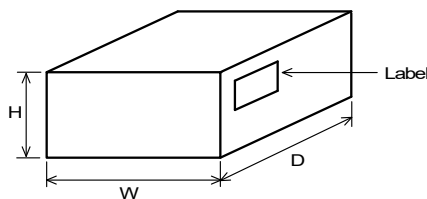

Outer Case Dimensions (mm)			Standard Reel Quantity in Outer Case (Reel)
W	D	H	
186	186	93	5

\* Above Outer Case size is typical. It depends on a quantity of an order.

## 11. ⚠ Caution

### Limitation of Applications

Please contact us before using our products for the applications listed below which require especially high reliability for the prevention of defects which might directly cause damage to the third party's life, body or property.

- |                                   |  |
|-----------------------------------|--|
| (1) Aircraft equipment            | (6) Transportation equipment (vehicles, trains, ships, etc.)   |
| (2) Aerospace equipment           | (7) Traffic signal equipment   |
| (3) Undersea equipment            | (8) Disaster prevention / crime prevention equipment   |
| (4) Power plant control equipment | (9) Data-processing equipment  |
| (5) Medical equipment             | (10) Applications of similar complexity and /or reliability requirements to the applications listed in the above |

## 12. Notice

Products can only be soldered with reflow.

This product is designed for solder mounting.

Please consult us in advance for applying other mounting method such as conductive adhesive.

### 12.1 Land pattern designing

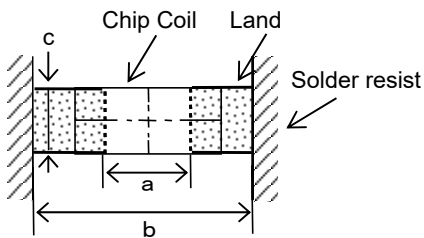

a	0.3
b	0.9
c	0.24

(in mm)

### 12.2 Flux, Solder

- Use rosin-based flux.  
Don't use highly acidic flux with halide content exceeding 0.2(wt)% (chlorine conversion value).  
Don't use water-soluble flux.
- Use Sn-3.0Ag-0.5Cu solder.
- Standard thickness of solder paste : 100  $\mu$ m.

### 12.3 Reflow soldering conditions

- Pre-heating should be in such a way that the temperature difference between solder and product surface is limited to 150°C max. Cooling into solvent after soldering also should be in such a way that the temperature difference is limited to 100°C max.  
Insufficient pre-heating may cause cracks on the product, resulting in the deterioration of products quality.
- Standard soldering profile and the limit soldering profile is as follows.  
The excessive limit soldering conditions may cause leaching of the electrode and / or resulting in the deterioration of product quality.



• Reflow soldering profile

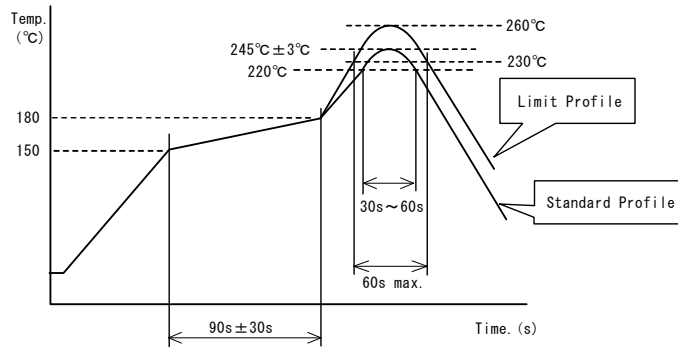

	Standard Profile	Limit Profile
Pre-heating	150°C~180°C , 90s±30s	
Heating	above 220°C, 30s~60s	above 230°C, 60s max.
Peak temperature	245°C±3°C	260°C, 10s
Cycle of reflow	2 times	

### 12.4 Reworking with soldering iron

The following conditions must be strictly followed when using a soldering iron.

Pre-heating	150°C, 1 min
Tip temperature	350°C max.
Soldering iron output	80W max.
Tip diameter	φ3mm max.
Soldering time	3(+1,-0)s
Time	2 times

Note : Do not directly touch the products with the tip of the soldering iron in order to prevent the crack on the products due to the thermal shock.

### 12.5 Solder Volume

• Solder shall be used not to be exceeded the upper limits as shown below.

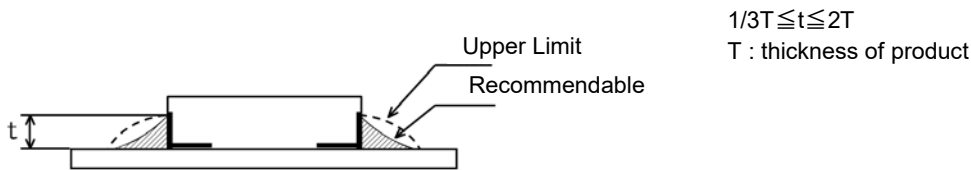

Accordingly increasing the solder volume, the mechanical stress to Chip is also increased. Exceeding solder volume may cause the failure of mechanical or electrical performance and become easy to tilt.

### 12.6 Attention regarding P.C.B. bending

The following shall be considered when designing and laying out P.C.B.'s.

- (1) P.C.B. shall be designed so that products are not subject to the mechanical stress due to warping the board.

[Products direction]

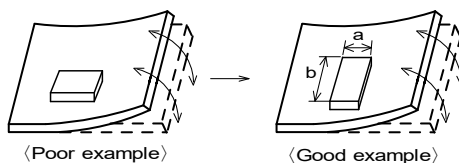

Products shall be located in the sideways direction (Length: a < b) to the mechanical stress.

(2) Components location on P.C.B. separation.

It is effective to implement the following measures, to reduce stress in separating the board.

It is best to implement all of the following three measures; however, implement as many measures as possible to reduce stress.

Contents of Measures	Stress Level
(1) Turn the mounting direction of the component parallel to the board separation surface.	$A > D *1$
(2) Add slits in the board separation part.	$A > B$
(3) Keep the mounting position of the component away from the board separation surface.	$A > C$

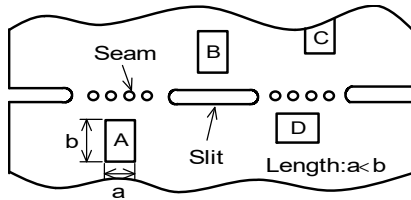

\*1  $A > D$  is valid when stress is added vertically to the perforation as with Hand Separation. If a Cutting Disc is used, stress will be diagonal to the PCB, therefore  $A > D$  is invalid.

(3) Mounting Components Near Screw Holes

When a component is mounted near a screw hole, it may be affected by the board deflection that occurs during the tightening of the screw. Mount the capacitor in a position as far away from the screw holes as possible.

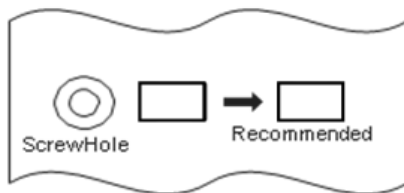

### 12.7 Cleaning Conditions

Products shall be cleaned on the following conditions.

- (1) Cleaning temperature shall be limited to 60°C max.(40°C max for IPA)
- (2) Ultrasonic cleaning shall comply with the following conditions with avoiding the resonance phenomenon at the mounted products and P.C.B.

Power : 20 W / l max.      Frequency : 28kHz to 40kHz      Time : 5 min max.

(3) Cleaner

1. Alcohol type cleaner  
Isopropyl alcohol (IPA)
2. Aqueous agent  
PINE ALPHA ST-100S

(4) There shall be no residual flux and residual cleaner after cleaning.

In the case of using aqueous agent, products shall be dried completely after rinse with de-ionized water in order to remove the cleaner.

(5) Other cleaning      Please contact us.

### 12.8 Resin coating

When products are coated with resin, please contact us in advance.

### 12.9 Handling of a substrate

(1) There is a possibility of chip cracking caused by PCB expansion/contraction with heat, because stress on a chip is different depending on PCB material and structure.

When the thermal expansion coefficient greatly differs between the board used for mounting and the chip, it will cause cracking of the chip due to the thermal expansion and contraction.

The chip is assumed to be mounted on the PCB of glass-epoxy material, and we don't test with other PCB material which has different thermal expansion coefficient from Glass-epoxy.

When other PCB materials are considered, please be sure to evaluate by yourself.

(2)After mounting products on a substrate, do not apply any stress to the product caused by bending or twisting to the substrate when cropping the substrate, inserting and removing a connector from the substrate or tightening screw to the substrate.

Excessive mechanical stress may cause cracking in the product.

In case of the mounting on flexible PCB, there is a possibility of chip cracking caused by mechanical stress even from small bending or twisting.

When the flexible PCB is considered, please be sure to evaluate by yourself.

Bending

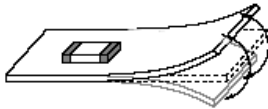

Twisting

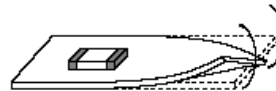

## 12.10 Storage and Handling Requirements

### (1) Storage period

Use the products within 12 months after delivered.

Solderability should be checked if this period is exceeded.

### (2) Storage conditions

•Products should be stored in the warehouse on the following conditions.

Temperature : -10°C ~ 40°C

Humidity : 30% to 70% relative humidity No rapid change on temperature and humidity.

•Products should not be stored on bulk packaging condition to prevent the chipping of the core and the breaking of winding wire caused by the collision between the products.

•Products should be stored on the palette for the prevention of the influence from humidity, dust and so on.

•Products should be stored in the warehouse without heat shock, vibration, direct sunlight and so on.

### (3) Handling Condition

Care should be taken when transporting or handling product to avoid excessive vibration or mechanical shock.

## 13 Note

(1)Please make sure that your product has been evaluated in view of your specifications with our product being mounted to your product.

(2)You are requested not to use our product deviating from the reference specifications.

(3)The contents of this reference specification are subject to change without advance notice.

Please approve our product specifications or transact the approval sheet for product specifications before ordering.

# Reference Only

**<Electrical Performance:Measuring Method of Inductance/Q>**

(1) Residual elements and stray elements of test fixture can be described by F-parameter shown in following.

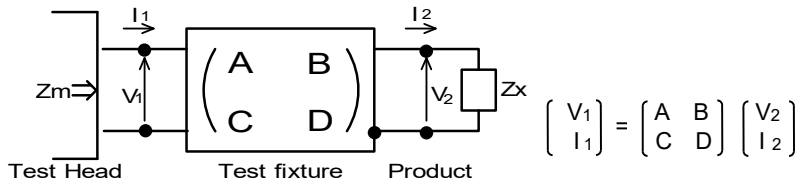

(2) The impedance of chip coil  $Z_x$  and measured value  $Z_m$  can be described by input/output current/voltage.

$$Z_m = \frac{V_1}{I_1} \quad , \quad Z_x = \frac{V_2}{I_2}$$

(3) Thus, the relation between  $Z_x$  and  $Z_m$  is following;

$$Z_x = \alpha \frac{Z_m - \beta}{1 - Z_m \Gamma} \quad \text{where, } \alpha = D / A = 1$$

$$\beta = B / D = Z_{sm} - (1 - Y_{om} Z_{sm}) Z_{ss}$$

$$\Gamma = C / A = Y_{om}$$

- $Z_{sm}$ :measured impedance of short chip
- $Z_{ss}$ :residual impedance of short chip (0.480nH)
- $Y_{om}$ :measured admittance when opening the fixture

(4)  $L_x$  and  $Q_x$  shall be calculated with the following equation.

$$L_x = \frac{\text{Im}(Z_x)}{2\pi f} \quad , \quad Q_x = \frac{\text{Im}(Z_x)}{\text{Re}(Z_x)}$$

$L_x$  :Inductance of chip coil  
 $Q_x$ :Q of chip coil  
 $f$  :Measuring frequency

单击下面可查看定价，库存，交付和生命周期等信息

[>>Murata\(村田\)](#)