

CHIP COILS (CHIP INDUCTORS) LQP03HQ□□□□02□ REFERENCE SPECIFICATION

1. Scope

This reference specification applies to chip coils (chip inductors) LQP03HQ_02 series for general electronic equipment.

2. Part Numbering

(Ex.) LQ	P	03	H	Q	0N5	W	0	2	D
Product ID	Structure	Dimension (L × W)	Application and characteristic	Category	Inductance	Tolerance	Performance	Electrode specification	Packaging D: taping *B: bulk

*B: Bulk packing is also available (taping condition: however, products without reels are put in plastic bags).

3. Part Number and Rating

Operating temperature range	-55°C to +125°C
Storage temperature range	-55°C to +125°C

Customer Part number	Murata Part number	Inductance		Q (Min.)	DC resistance (Ω max.)	Self-resonant frequency (MHz)		Rated current (mA)
		Nominal value (nH)	Tolerance			Lower limit	*Typical value	
	LQP03HQ0N5W02D	0.5	W: ±0.05 nH	20	0.04	20000	>20000	1100
	LQP03HQ0N5B02D	0.5	B: ±0.1 nH	20	0.04	20000	>20000	1100
	LQP03HQ0N5C02D	0.5	C: ±0.2 nH	20	0.04	20000	>20000	1100
	LQP03HQ0N6W02D	0.6	W: ±0.05 nH	20	0.04	20000	>20000	1100
	LQP03HQ0N6B02D	0.6	B: ±0.1 nH	20	0.04	20000	>20000	1100
	LQP03HQ0N6C02D	0.6	C: ±0.2 nH	20	0.04	20000	>20000	1100
	LQP03HQ0N7W02D	0.7	W: ±0.05 nH	20	0.04	20000	>20000	1100
	LQP03HQ0N7B02D	0.7	B: ±0.1 nH	20	0.04	20000	>20000	1100
	LQP03HQ0N7C02D	0.7	C: ±0.2 nH	20	0.04	20000	>20000	1100
	LQP03HQ0N8W02D	0.8	W: ±0.05 nH	20	0.04	18000	>20000	1100
	LQP03HQ0N8B02D	0.8	B: ±0.1 nH	20	0.04	18000	>20000	1100
	LQP03HQ0N8C02D	0.8	C: ±0.2 nH	20	0.04	18000	>20000	1100
	LQP03HQ0N9W02D	0.9	W: ±0.05 nH	20	0.04	18000	>20000	1100
	LQP03HQ0N9B02D	0.9	B: ±0.1 nH	20	0.04	18000	>20000	1100
	LQP03HQ0N9C02D	0.9	C: ±0.2 nH	20	0.04	18000	>20000	1100
	LQP03HQ1N0W02D	1.0	W: ±0.05 nH	20	0.04	16000	20000	1100
	LQP03HQ1N0B02D	1.0	B: ±0.1 nH	20	0.04	16000	20000	1100
	LQP03HQ1N0C02D	1.0	C: ±0.2 nH	20	0.04	16000	20000	1100
	LQP03HQ1N1W02D	1.1	W: ±0.05 nH	20	0.04	14000	18000	1100
	LQP03HQ1N1B02D	1.1	B: ±0.1 nH	20	0.04	14000	18000	1100
	LQP03HQ1N1C02D	1.1	C: ±0.2 nH	20	0.04	14000	18000	1100
	LQP03HQ1N2W02D	1.2	W: ±0.05 nH	20	0.04	13000	17000	1100
	LQP03HQ1N2B02D	1.2	B: ±0.1 nH	20	0.04	13000	17000	1100
	LQP03HQ1N2C02D	1.2	C: ±0.2 nH	20	0.04	13000	17000	1100
	LQP03HQ1N3W02D	1.3	W: ±0.05 nH	20	0.04	13000	20000	1100
	LQP03HQ1N3B02D	1.3	B: ±0.1 nH	20	0.04	13000	20000	1100
	LQP03HQ1N3C02D	1.3	C: ±0.2 nH	20	0.04	13000	20000	1100
	LQP03HQ1N4W02D	1.4	W: ±0.05 nH	20	0.04	12000	20000	1100
	LQP03HQ1N4B02D	1.4	B: ±0.1 nH	20	0.04	12000	20000	1100

MURATA MFG CO., LTD

Customer Part number	Murata Part number	Inductance		Q (Min.)	DC resistance (Ω max.)	Self-resonant frequency (MHz)		Rated current (mA)
		Nominal value (nH)	Tolerance			Lower limit	*Typical value	
	LQP03HQ1N4C02D	1.4	C: ± 0.2 nH	20	0.04	12000	20000	1100
	LQP03HQ1N5W02D	1.5	W: ± 0.05 nH	20	0.05	12000	18500	1000
	LQP03HQ1N5B02D	1.5	B: ± 0.1 nH	20	0.05	12000	18500	1000
	LQP03HQ1N5C02D	1.5	C: ± 0.2 nH	20	0.05	12000	18500	1000
	LQP03HQ1N6W02D	1.6	W: ± 0.05 nH	20	0.05	10000	16000	1000
	LQP03HQ1N6B02D	1.6	B: ± 0.1 nH	20	0.05	10000	16000	1000
	LQP03HQ1N6C02D	1.6	C: ± 0.2 nH	20	0.05	10000	16000	1000
	LQP03HQ1N7W02D	1.7	W: ± 0.05 nH	20	0.07	10000	16000	800
	LQP03HQ1N7B02D	1.7	B: ± 0.1 nH	20	0.07	10000	16000	800
	LQP03HQ1N7C02D	1.7	C: ± 0.2 nH	20	0.07	10000	16000	800
	LQP03HQ1N8W02D	1.8	W: ± 0.05 nH	20	0.08	10000	16000	800
	LQP03HQ1N8B02D	1.8	B: ± 0.1 nH	20	0.08	10000	16000	800
	LQP03HQ1N8C02D	1.8	C: ± 0.2 nH	20	0.08	10000	16000	800
	LQP03HQ1N9W02D	1.9	W: ± 0.05 nH	20	0.12	10000	14700	600
	LQP03HQ1N9B02D	1.9	B: ± 0.1 nH	20	0.12	10000	14700	600
	LQP03HQ1N9C02D	1.9	C: ± 0.2 nH	20	0.12	10000	14700	600
	LQP03HQ2N0W02D	2.0	W: ± 0.05 nH	20	0.12	9000	15900	600
	LQP03HQ2N0B02D	2.0	B: ± 0.1 nH	20	0.12	9000	15900	600
	LQP03HQ2N0C02D	2.0	C: ± 0.2 nH	20	0.12	9000	15900	600
	LQP03HQ2N1W02D	2.1	W: ± 0.05 nH	20	0.12	9000	14300	600
	LQP03HQ2N1B02D	2.1	B: ± 0.1 nH	20	0.12	9000	14300	600
	LQP03HQ2N1C02D	2.1	C: ± 0.2 nH	20	0.12	9000	14300	600
	LQP03HQ2N2W02D	2.2	W: ± 0.05 nH	20	0.12	9000	14300	600
	LQP03HQ2N2B02D	2.2	B: ± 0.1 nH	20	0.12	9000	14300	600
	LQP03HQ2N2C02D	2.2	C: ± 0.2 nH	20	0.12	9000	14300	600
	LQP03HQ2N3W02D	2.3	W: ± 0.05 nH	20	0.12	9000	13800	600
	LQP03HQ2N3B02D	2.3	B: ± 0.1 nH	20	0.12	9000	13800	600
	LQP03HQ2N3C02D	2.3	C: ± 0.2 nH	20	0.12	9000	13800	600
	LQP03HQ2N4W02D	2.4	W: ± 0.05 nH	20	0.12	9000	13000	600
	LQP03HQ2N4B02D	2.4	B: ± 0.1 nH	20	0.12	9000	13000	600
	LQP03HQ2N4C02D	2.4	C: ± 0.2 nH	20	0.12	9000	13000	600
	LQP03HQ2N5W02D	2.5	W: ± 0.05 nH	20	0.12	9000	13000	600
	LQP03HQ2N5B02D	2.5	B: ± 0.1 nH	20	0.12	9000	13000	600
	LQP03HQ2N5C02D	2.5	C: ± 0.2 nH	20	0.12	9000	13000	600
	LQP03HQ2N6B02D	2.6	B: ± 0.1 nH	20	0.12	9000	13000	600
	LQP03HQ2N6C02D	2.6	C: ± 0.2 nH	20	0.12	9000	13000	600
	LQP03HQ2N7B02D	2.7	B: ± 0.1 nH	20	0.12	9000	11600	600
	LQP03HQ2N7C02D	2.7	C: ± 0.2 nH	20	0.12	9000	11600	600
	LQP03HQ2N8B02D	2.8	B: ± 0.1 nH	20	0.12	8000	10500	600
	LQP03HQ2N8C02D	2.8	C: ± 0.2 nH	20	0.12	8000	10500	600
	LQP03HQ2N9B02D	2.9	B: ± 0.1 nH	20	0.12	8000	10500	600
	LQP03HQ2N9C02D	2.9	C: ± 0.2 nH	20	0.12	8000	10500	600
	LQP03HQ3N0B02D	3.0	B: ± 0.1 nH	20	0.12	8000	10500	600
	LQP03HQ3N0C02D	3.0	C: ± 0.2 nH	20	0.12	8000	10500	600

Customer Part number	Murata Part number	Inductance		Q (Min.)	DC resistance (Ω max.)	Self-resonant frequency (MHz)		Rated current (mA)
		Nominal value (nH)	Tolerance			Lower limit	*Typical value	
	LQP03HQ3N1B02D	3.1	B: ± 0.1 nH	20	0.17	7500	10500	500
	LQP03HQ3N1C02D	3.1	C: ± 0.2 nH	20	0.17	7500	10500	500
	LQP03HQ3N2B02D	3.2	B: ± 0.1 nH	20	0.17	7000	10500	500
	LQP03HQ3N2C02D	3.2	C: ± 0.2 nH	20	0.17	7000	10500	500
	LQP03HQ3N3B02D	3.3	B: ± 0.1 nH	20	0.17	7000	10500	500
	LQP03HQ3N3C02D	3.3	C: ± 0.2 nH	20	0.17	7000	10500	500
	LQP03HQ3N4B02D	3.4	B: ± 0.1 nH	20	0.17	7000	9500	500
	LQP03HQ3N4C02D	3.4	C: ± 0.2 nH	20	0.17	7000	9500	500
	LQP03HQ3N5B02D	3.5	B: ± 0.1 nH	20	0.17	7000	9500	500
	LQP03HQ3N5C02D	3.5	C: ± 0.2 nH	20	0.17	7000	9500	500
	LQP03HQ3N6B02D	3.6	B: ± 0.1 nH	20	0.17	7000	9500	500
	LQP03HQ3N6C02D	3.6	C: ± 0.2 nH	20	0.17	7000	9500	500
	LQP03HQ3N7B02D	3.7	B: ± 0.1 nH	20	0.17	7000	9500	500
	LQP03HQ3N7C02D	3.7	C: ± 0.2 nH	20	0.17	7000	9500	500
	LQP03HQ3N8B02D	3.8	B: ± 0.1 nH	20	0.17	7000	9500	500
	LQP03HQ3N8C02D	3.8	C: ± 0.2 nH	20	0.17	7000	9500	500
	LQP03HQ3N9B02D	3.9	B: ± 0.1 nH	20	0.17	7000	9500	500
	LQP03HQ3N9C02D	3.9	C: ± 0.2 nH	20	0.17	7000	9500	500
	LQP03HQ4N0B02D	4.0	B: ± 0.1 nH	20	0.17	7000	9500	500
	LQP03HQ4N0C02D	4.0	C: ± 0.2 nH	20	0.17	7000	9500	500
	LQP03HQ4N1B02D	4.1	B: ± 0.1 nH	20	0.17	7000	9500	500
	LQP03HQ4N1C02D	4.1	C: ± 0.2 nH	20	0.17	7000	9500	500
	LQP03HQ4N2B02D	4.2	B: ± 0.1 nH	20	0.17	7000	9500	500
	LQP03HQ4N2C02D	4.2	C: ± 0.2 nH	20	0.17	7000	9500	500
	LQP03HQ4N3H02D	4.3	H: $\pm 3\%$	20	0.17	7000	9500	500
	LQP03HQ4N3J02D	4.3	J: $\pm 5\%$	20	0.17	7000	9500	500
	LQP03HQ4N4H02D	4.4	H: $\pm 3\%$	20	0.25	7000	9500	400
	LQP03HQ4N4J02D	4.4	J: $\pm 5\%$	20	0.25	7000	9500	400
	LQP03HQ4N5H02D	4.5	H: $\pm 3\%$	20	0.25	7000	9500	400
	LQP03HQ4N5J02D	4.5	J: $\pm 5\%$	20	0.25	7000	9500	400
	LQP03HQ4N6H02D	4.6	H: $\pm 3\%$	20	0.25	7000	9500	400
	LQP03HQ4N6J02D	4.6	J: $\pm 5\%$	20	0.25	7000	9500	400
	LQP03HQ4N7H02D	4.7	H: $\pm 3\%$	20	0.25	7000	9500	400
	LQP03HQ4N7J02D	4.7	J: $\pm 5\%$	20	0.25	7000	9500	400
	LQP03HQ4N8H02D	4.8	H: $\pm 3\%$	20	0.25	5500	7700	400
	LQP03HQ4N8J02D	4.8	J: $\pm 5\%$	20	0.25	5500	7700	400
	LQP03HQ4N9H02D	4.9	H: $\pm 3\%$	20	0.25	5500	7700	400
	LQP03HQ4N9J02D	4.9	J: $\pm 5\%$	20	0.25	5500	7700	400
	LQP03HQ5N0H02D	5.0	H: $\pm 3\%$	20	0.25	5500	7700	400
	LQP03HQ5N0J02D	5.0	J: $\pm 5\%$	20	0.25	5500	7700	400
	LQP03HQ5N1H02D	5.1	H: $\pm 3\%$	20	0.25	5500	7700	400
	LQP03HQ5N1J02D	5.1	J: $\pm 5\%$	20	0.25	5500	7700	400
	LQP03HQ5N6H02D	5.6	H: $\pm 3\%$	20	0.25	5500	7700	400
	LQP03HQ5N6J02D	5.6	J: $\pm 5\%$	20	0.25	5500	7700	400

Customer Part number	Murata Part number	Inductance		Q (Min.)	DC resistance (Ω max.)	Self-resonant frequency (MHz)		Rated current (mA)
		Nominal value (nH)	Tolerance			Lower limit	*Typical value	
	LQP03HQ6N2H02D	6.2	H: \pm 3%	20	0.25	5500	7700	400
	LQP03HQ6N2J02D	6.2	J: \pm 5%	20	0.25	5500	7700	400
	LQP03HQ6N8H02D	6.8	H: \pm 3%	20	0.25	5500	7300	400
	LQP03HQ6N8J02D	6.8	J: \pm 5%	20	0.25	5500	7300	400
	LQP03HQ7N5H02D	7.5	H: \pm 3%	20	0.3	4500	6400	400
	LQP03HQ7N5J02D	7.5	J: \pm 5%	20	0.3	4500	6400	400
	LQP03HQ8N2H02D	8.2	H: \pm 3%	20	0.4	4500	6400	300
	LQP03HQ8N2J02D	8.2	J: \pm 5%	20	0.4	4500	6400	300
	LQP03HQ9N1H02D	9.1	H: \pm 3%	20	0.4	4500	6400	300
	LQP03HQ9N1J02D	9.1	J: \pm 5%	20	0.4	4500	6400	300
	LQP03HQ10NH02D	10	H: \pm 3%	20	0.4	4500	5900	300
	LQP03HQ10NJ02D	10	J: \pm 5%	20	0.4	4500	5900	300
	LQP03HQ11NH02D	11	H: \pm 3%	20	0.5	4000	5200	300
	LQP03HQ11NJ02D	11	J: \pm 5%	20	0.5	4000	5200	300
	LQP03HQ12NH02D	12	H: \pm 3%	20	0.5	4000	5200	300
	LQP03HQ12NJ02D	12	J: \pm 5%	20	0.5	4000	5200	300
	LQP03HQ13NH02D	13	H: \pm 3%	20	0.5	4000	5100	300
	LQP03HQ13NJ02D	13	J: \pm 5%	20	0.5	4000	5100	300
	LQP03HQ15NH02D	15	H: \pm 3%	20	0.7	3500	4200	300
	LQP03HQ15NJ02D	15	J: \pm 5%	20	0.7	3500	4200	300
	LQP03HQ16NH02D	16	H: \pm 3%	20	0.8	3500	4200	250
	LQP03HQ16NJ02D	16	J: \pm 5%	20	0.8	3500	4200	250
	LQP03HQ18NH02D	18	H: \pm 3%	20	0.8	3500	4200	250
	LQP03HQ18NJ02D	18	J: \pm 5%	20	0.8	3500	4200	250
	LQP03HQ20NH02D	20	H: \pm 3%	20	0.8	3000	4200	250
	LQP03HQ20NJ02D	20	J: \pm 5%	20	0.8	3000	4200	250
	LQP03HQ22NH02D	22	H: \pm 3%	20	0.82	3000	3950	250
	LQP03HQ22NJ02D	22	J: \pm 5%	20	0.82	3000	3950	250
	LQP03HQ24NH02D	24	H: \pm 3%	15	1.6	2000	2900	170
	LQP03HQ24NJ02D	24	J: \pm 5%	15	1.6	2000	2900	170
	LQP03HQ27NH02D	27	H: \pm 3%	15	1.6	2000	2900	170
	LQP03HQ27NJ02D	27	J: \pm 5%	15	1.6	2000	2900	170
	LQP03HQ30NH02D	30	H: \pm 3%	12	2.0	1700	2700	150
	LQP03HQ30NJ02D	30	J: \pm 5%	12	2.0	1700	2700	150
	LQP03HQ33NH02D	33	H: \pm 3%	12	2.0	1700	2600	150
	LQP03HQ33NJ02D	33	J: \pm 5%	12	2.0	1700	2600	150
	LQP03HQ36NH02D	36	H: \pm 3%	12	2.0	1500	2400	150
	LQP03HQ36NJ02D	36	J: \pm 5%	12	2.0	1500	2400	150
	LQP03HQ39NH02D	39	H: \pm 3%	12	2.0	1500	2200	150
	LQP03HQ39NJ02D	39	J: \pm 5%	12	2.0	1500	2200	150
	LQP03HQ43NH02D	43	H: \pm 3%	12	2.5	1300	2200	130
	LQP03HQ43NJ02D	43	J: \pm 5%	12	2.5	1300	2200	130
	LQP03HQ47NH02D	47	H: \pm 3%	12	2.5	1300	2000	130
	LQP03HQ47NJ02D	47	J: \pm 5%	12	2.5	1300	2000	130

Customer Part number	Murata Part number	Inductance		Q (Min.)	DC resistance (Ω max.)	Self-resonant frequency (MHz)		Rated current (mA)
		Nominal value (nH)	Tolerance			Lower limit	*Typical value	
	LQP03HQ51NH02D	51	H: $\pm 3\%$	12	2.5	1200	2000	130
	LQP03HQ51NJ02D	51	J: $\pm 5\%$	12	2.5	1200	2000	130
	LQP03HQ56NH02D	56	H: $\pm 3\%$	12	2.5	1200	2000	130
	LQP03HQ56NJ02D	56	J: $\pm 5\%$	12	2.5	1200	2000	130
	LQP03HQ62NH02D	62	H: $\pm 3\%$	12	5.0	1100	1800	100
	LQP03HQ62NJ02D	62	J: $\pm 5\%$	12	5.0	1100	1800	100
	LQP03HQ68NH02D	68	H: $\pm 3\%$	12	5.0	1100	1500	100
	LQP03HQ68NJ02D	68	J: $\pm 5\%$	12	5.0	1100	1500	100
	LQP03HQ75NH02D	75	H: $\pm 3\%$	10	5.0	1100	1400	100
	LQP03HQ75NJ02D	75	J: $\pm 5\%$	10	5.0	1100	1400	100
	LQP03HQ82NH02D	82	H: $\pm 3\%$	10	5.0	1000	1400	100
	LQP03HQ82NJ02D	82	J: $\pm 5\%$	10	5.0	1000	1400	100
	LQP03HQ91NH02D	91	H: $\pm 3\%$	10	7.0	1000	1300	80
	LQP03HQ91NJ02D	91	J: $\pm 5\%$	10	7.0	1000	1300	80
	LQP03HQR10H02D	100	H: $\pm 3\%$	10	7.0	900	1300	80
	LQP03HQR10J02D	100	J: $\pm 5\%$	10	7.0	900	1300	80
	LQP03HQR11H02D	110	H: $\pm 3\%$	10	8.0	900	1100	80
	LQP03HQR11J02D	110	J: $\pm 5\%$	10	8.0	900	1100	80
	LQP03HQR12H02D	120	H: $\pm 3\%$	10	8.0	800	1100	80
	LQP03HQR12J02D	120	J: $\pm 5\%$	10	8.0	800	1100	80
	LQP03HQR13H02D	130	H: $\pm 3\%$	7	8.0	700	960	80
	LQP03HQR13J02D	130	J: $\pm 5\%$	7	8.0	700	960	80
	LQP03HQR15H02D	150	H: $\pm 3\%$	7	8.0	700	880	80
	LQP03HQR15J02D	150	J: $\pm 5\%$	7	8.0	700	880	80
	LQP03HQR16H02D	160	H: $\pm 3\%$	9	8.0	700	1100	80
	LQP03HQR16J02D	160	J: $\pm 5\%$	9	8.0	700	1100	80
	LQP03HQR18H02D	180	H: $\pm 3\%$	9	8.5	700	1000	80
	LQP03HQR18J02D	180	J: $\pm 5\%$	9	8.5	700	1000	80
	LQP03HQR20H02D	200	H: $\pm 3\%$	9	9.0	700	1000	75
	LQP03HQR20J02D	200	J: $\pm 5\%$	9	9.0	700	1000	75
	LQP03HQR22H02D	220	H: $\pm 3\%$	9	9.5	650	900	75
	LQP03HQR22J02D	220	J: $\pm 5\%$	9	9.5	650	900	75
	LQP03HQR24H02D	240	H: $\pm 3\%$	9	10.0	650	900	70
	LQP03HQR24J02D	240	J: $\pm 5\%$	9	10.0	650	900	70
	LQP03HQR27H02D	270	H: $\pm 3\%$	9	11.0	650	850	70
	LQP03HQR27J02D	270	J: $\pm 5\%$	9	11.0	650	850	70
	LQP03HQR30H02D	300	H: $\pm 3\%$	9	12.0	600	800	65
	LQP03HQR30J02D	300	J: $\pm 5\%$	9	12.0	600	800	65
	LQP03HQR33H02D	330	H: $\pm 3\%$	9	13.0	550	750	65
	LQP03HQR33J02D	330	J: $\pm 5\%$	9	13.0	550	750	65
	LQP03HQR36H02D	360	H: $\pm 3\%$	9	13.5	500	700	60
	LQP03HQR36J02D	360	J: $\pm 5\%$	9	13.5	500	700	60
	LQP03HQR39H02D	390	H: $\pm 3\%$	8	14.5	500	650	60
	LQP03HQR39J02D	390	J: $\pm 5\%$	8	14.5	500	650	60

Customer Part number	Murata Part number	Inductance		Q (Min.)	DC resistance (Ω max.)	Self-resonant frequency (MHz)		Rated current (mA)
		Nominal value (nH)	Tolerance			Lower limit	*Typical value	
	LQP03HQR43H02D	430	H: $\pm 3\%$	8	15.5	500	650	50
	LQP03HQR43J02D	430	J: $\pm 5\%$	8	15.5	500	650	50
	LQP03HQR47H02D	470	H: $\pm 3\%$	8	16.5	450	600	50
	LQP03HQR47J02D	470	J: $\pm 5\%$	8	16.5	450	600	50

* Typical value is actual performance.

4. Testing Conditions

Unless otherwise specified	Temperature: ordinary temperature (15°C to 35°C) Humidity: ordinary humidity [25% to 85% (RH)]
In case of doubt	Temperature: 20°C \pm 2°C Humidity: 60% to 70% (RH) Atmospheric pressure: 86 kPa to 106 kPa

5. Appearance and Dimensions

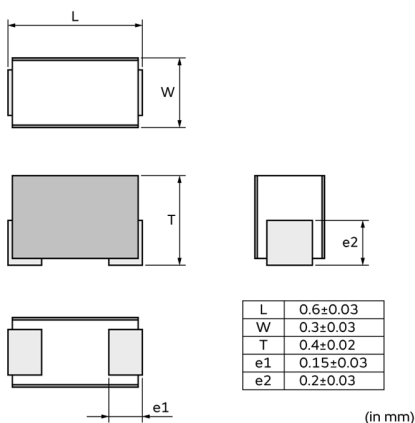

Unit mass (typical value): 0.22 mg

6. Marking

Side surface identification marking :blue

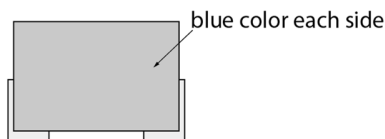

7. Electrical Performance

No.	Item	Specification	Test method						
7.1	Inductance	Meet chapter 3 ratings.	Measuring equipment: Keysight E4991A or the equivalent Measuring frequency:						
7.2	Q	Meet chapter 3 ratings.							
			<table border="1" style="margin-left: 20px;"> <tr><td>500 MHz</td><td>0.5 nH to 30 nH</td></tr> <tr><td>300 MHz</td><td>33 nH to 120 nH</td></tr> <tr><td>100 MHz</td><td>130 nH to 470 nH</td></tr> </table>	500 MHz	0.5 nH to 30 nH	300 MHz	33 nH to 120 nH	100 MHz	130 nH to 470 nH
500 MHz	0.5 nH to 30 nH								
300 MHz	33 nH to 120 nH								
100 MHz	130 nH to 470 nH								
			Measuring conditions: Measurement signal level: Approx. 0 dBm Electrical length: 10 mm Weight: Approx. 1 N to 5 N						

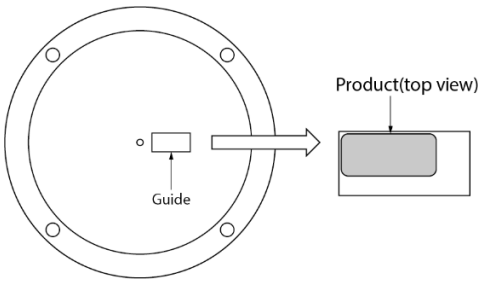
No.	Item	Specification	Test method
			<p>Measuring fixture: Keysight 16197A Position the chip coil under test as shown in the measuring example below and connect it to the electrode by applying weight. Measurement example:</p>  <p>Measuring method: see "Electrical performance: Measuring method for inductance/Q" in the Appendix.</p>
7.3	DC resistance	Meet chapter 3 ratings.	Measuring equipment: digital multimeter
7.4	Self-resonant frequency	Meet chapter 3 ratings.	Measuring equipment: Keysight N5230A or the equivalent
7.5	Rated current	Product temperature rise: 25°C max.	Apply the rated current specified in chapter 3.

8. Mechanical Performance

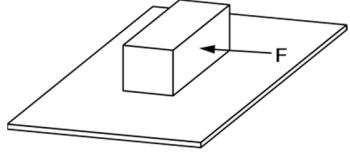
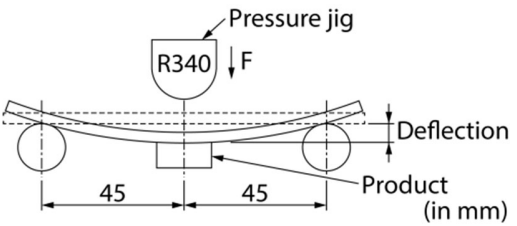
No.	Item	Specification	Test method
8.1	Shear test	No significant mechanical damage or no sign of electrode peeling off shall be observed.	<p>Test substrate: glass-epoxy substrate Applying force: 2 N Holding time: 5 s\pm1 s Force application direction:</p> 
8.2	Bending test	No significant mechanical damage or no sign of electrode peeling off shall be observed.	<p>Test substrate: glass-epoxy substrate (100 mm \times 40 mm \times 0.8 mm) Pressurizing speed: 1 mm/s Pressure jig: R340 Deflection: 1 mm Holding time: 30 s</p> 
8.3	Vibration	Appearance shall have no significant mechanical damage. Inductance change rate: within \pm 10%	<p>Oscillation frequency: 10 Hz to 2000 Hz to 10 Hz, for approx. 20 min Total amplitude: total amplitude of 1.5 mm or acceleration amplitude of 196 m/s², whichever is smaller Test time: 3 directions perpendicular to each other, 2 h for each direction (6 h in total)</p>
8.4	Solderability	90% or more of the outer electrode shall be covered with new solder seamlessly.	<p>Flux: immersed in ethanol solution with a rosin content of 25(wt)% for 5 s to 10 s Solder: Sn-3.0Ag-0.5Cu solder Pre-heating: 150°C\pm10°C/60 s to 90 s Solder temperature: 240°C\pm5°C Immersion time: 3 s\pm1 s</p>
8.5	Resistance to soldering heat	Appearance: No significant mechanical damage shall be observed.	<p>Flux: immersed in ethanol solution with a rosin content of 25(wt)% for 5 s to 10 s</p>

No.	Item	Specification	Test method
		Inductance change rate: within $\pm 10\%$	Solder: Sn-3.0Ag-0.5Cu solder Pre-heating: $150^{\circ}\text{C} \pm 10^{\circ}\text{C}/60\text{ s}$ to 90 s Solder temperature: $260^{\circ}\text{C} \pm 5^{\circ}\text{C}$ Immersion time: $5\text{ s} \pm 1\text{ s}$ Post-treatment: left at a room condition for $24\text{ h} \pm 2\text{ h}$

9. Environmental Performance

The product is soldered on a glass-epoxy substrate for test.

No.	Item	Specification	Test method
9.1	Heat resistance	Appearance: No significant mechanical damage shall be observed. Inductance change rate: within $\pm 10\%$	Temperature: $125^{\circ}\text{C} \pm 2^{\circ}\text{C}$ Test time: 1000 h (+48 h, -0 h) Post-treatment: left at a room condition for $24\text{ h} \pm 2\text{ h}$
9.2	Cold resistance	Appearance: No significant mechanical damage shall be observed. Inductance change rate: within $\pm 10\%$	Temperature: $-55^{\circ}\text{C} \pm 3^{\circ}\text{C}$ Test time: 1000 h (+48 h, -0 h) Post-treatment: left at a room condition for $24\text{ h} \pm 2\text{ h}$
9.3	Humidity	Appearance: No significant mechanical damage shall be observed. Inductance change rate: within $\pm 10\%$	Temperature: $40^{\circ}\text{C} \pm 2^{\circ}\text{C}$ Humidity: 90% (RH) to 95% (RH) Test time: 1000 h (+48 h, -0 h) Post-treatment: left at a room condition for $24\text{ h} \pm 2\text{ h}$
9.4	Temperature cycle	Appearance: No significant mechanical damage shall be observed. Inductance change rate: within $\pm 10\%$	Single cycle conditions: Step 1: $-55^{\circ}\text{C} \pm 2^{\circ}\text{C}/30\text{ min} \pm 3\text{ min}$ Step 2: ordinary temperature/10 min to 15 min Step 3: $+125^{\circ}\text{C} \pm 2^{\circ}\text{C}/30\text{ min} \pm 3\text{ min}$ Step 4: ordinary temperature/10 min to 15 min Number of testing: 10 cycles Post-treatment: left at a room condition for $24\text{ h} \pm 2\text{ h}$

10. Specification of Packaging

10.1 Appearance and dimensions of tape (8 mm width/paper tape)

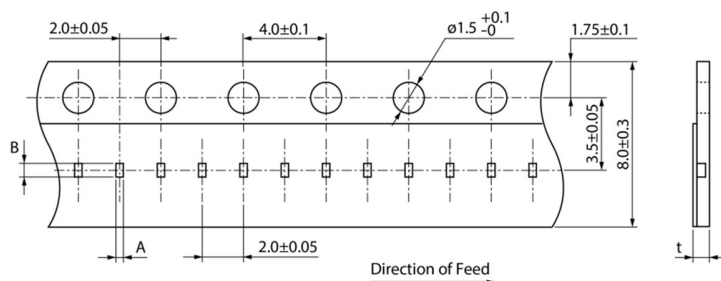

A	(0.36)
B	(0.68)
t	0.55 max.

(in mm)

■ Top view

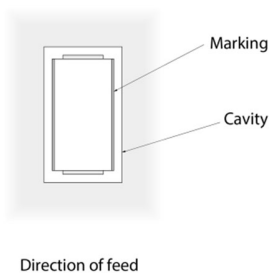

10.2 Taping specifications

Packing quantity (Standard quantity)	15000 pcs/reel
Packing method	The products are placed in cavities of a carrier tape and sealed by a cover tape (top tape and bottom tape when the cavities of the carrier tape are punched type).
Feed hole position	The feed holes on the carrier tape are on the right side when the cover tape (top tape when the cavities of the carrier tape are punched type) is pulled toward the user.
Joint	The carrier tape and cover tape (top tape when the cavities of the carrier tape are punched type) are seamless.
Number of missing products	Number of missing products within 0.1% of the number per reel or 1 pc., whichever is greater, and are not continuous. The specified quantity per reel is kept.

10.3 Break down force of tape

Cover tape (or top tape)	5 N min.
Bottom tape (only when the cavities of the carrier tape are punched type)	5 N min.

10.4 Peeling off force of tape

Speed of peeling off	300 mm/min
Peeling off force	0.1 N to 0.6 N (The lower limit is for typical value.)

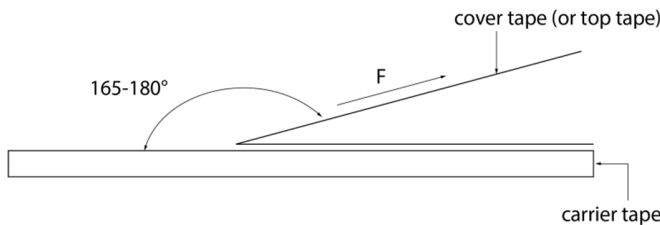

10.5 Dimensions of leader section, trailer section and reel

A vacant section is provided in the leader (start) section and trailer (end) section of the tape for the product. The leader section is further provided with an area consisting only of the cover tape (or top tape). (See the diagram below.)

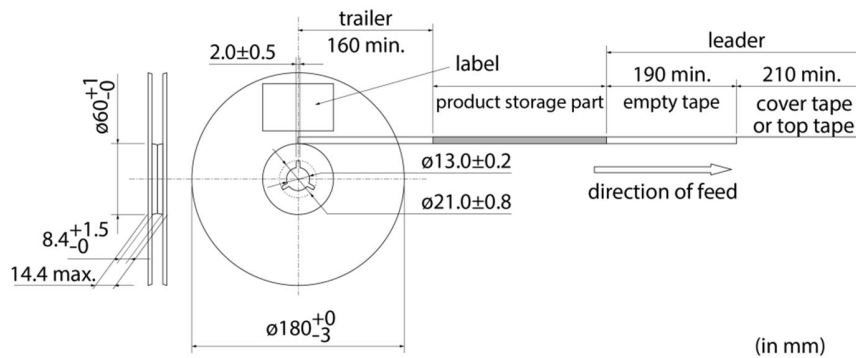

10.6 Marking for reel

Customer part number, Murata part number, inspection number (*1), RoHS marking (*2), quantity, etc.

*1 Expression of inspection No.: $\frac{\square\square}{(1)}$ $\frac{\circ\circ\circ\circ}{(2)}$ $\frac{\diamond\diamond\diamond}{(3)}$	(1) Factory code (2) Date First digit: year/last digit of year Second digit: month/Jan. to Sep. → 1 to 9, Oct. to Dec. → O, N, D Third, Fourth digit: day (3) Serial No.
*2 Expression of RoHS marking: ROHS- $\frac{Y}{(1)}$ $\frac{(\Delta)}{(2)}$	(1) RoHS regulation conformity (2) Murata classification number

10.7 Marking on outer box (corrugated box)

Customer name, purchasing order number, customer part number, Murata part number, RoHS marking (*2), quantity, etc.

10.8 Specification of outer box

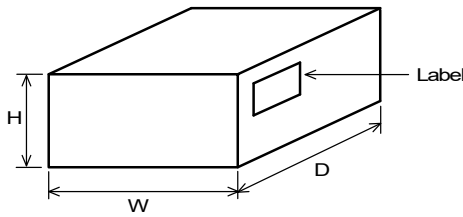

Dimensions of outer box (mm)			Standard reel quantity in outer box (reel)
W	D	H	
186	186	93	5
* Above outer box size is typical. It depends on a quantity of an order.			

11. ⚠Caution

11.1 Restricted applications

Please contact us before using our products for the applications listed below which require especially high reliability for the prevention of defects which might directly cause damage to the third party's life, body or property.

- | | | | |
|-------------------------------|---|------------------------------|---|
| (1) Aircraft equipment | (2) Aerospace equipment | (3) Undersea equipment | (4) Power plant control equipment |
| (5) Medical equipment | (6) Transportation equipment (vehicles, trains, ships, etc.) | (7) Traffic signal equipment | (8) Disaster/crime prevention equipment |
| (9) Data-processing equipment | (10) Applications of similar complexity and/or reliability requirements to the applications listed in the above | | |

11.2 Precautions on rating

Avoid using in exceeded the rated temperature range, rated voltage, or rated current. Usage when the ratings are exceeded could lead to wire breakage, burning, or other serious fault.

11.3 Inrush current

If an inrush current (or pulse current or rush current) that significantly exceeds the rated current is applied to the product, overheating could occur, resulting in wire breakage, burning, or other serious fault.

12. Precautions for Use

This product is for use only with reflow soldering. It is designed to be mounted by soldering. If you want to use other mounting method, for example, using a conductive adhesive, please consult us beforehand.

Also, if repeatedly subjected to temperature cycles or other thermal stress, due to the difference in the coefficient of thermal expansion with the mounting substrate, the solder (solder fillet part) in the mounting part may crack. The occurrence of cracks due to thermal stress is affected by the size of the land where mounted, the solder volume, and the heat dissipation of the mounting substrate. Carefully design it when a large change in ambient temperature is assumed.

12.1. Land dimensions

The following diagram shows the recommended land dimensions for reflow soldering:

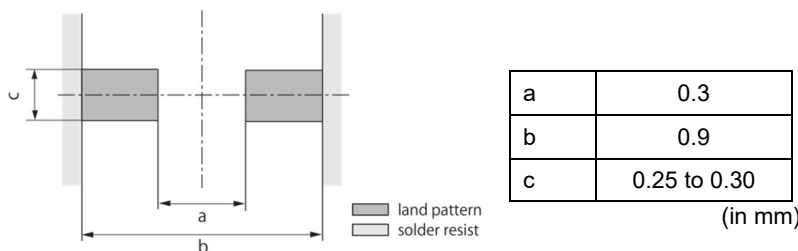

12.2 Flux and solder used

Flux	<ul style="list-style-type: none"> • Use a rosin-based flux. • Do not use a highly acidic flux with a halide content exceeding 0.2(wt)% (chlorine conversion value). • Do not use a water-soluble flux.
Solder	<ul style="list-style-type: none"> • Use Sn-3.0Ag-0.5Cu solder. • Standard thickness of solder paste: 100 μm

12.3 Soldering conditions (reflow)

- Pre-heating should be in such a way that the temperature difference between solder and product surface is limited to 150°C max.
Cooling into solvent after soldering also should be in such a way that the temperature difference is limited to 100°C max. Insufficient pre-heating may cause cracks on the product, resulting in the deterioration of product quality.
- Standard soldering profile and the limit soldering profile is as follows.
The excessive limit soldering conditions may cause leaching of the electrode and/or resulting in the deterioration of product quality.

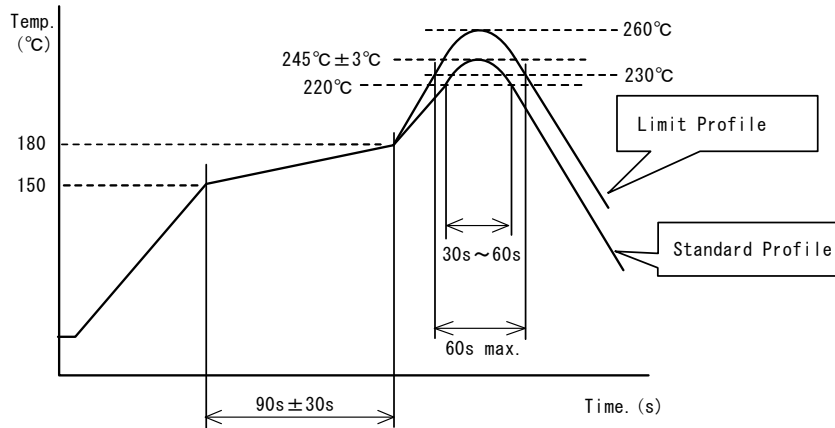

	Standard profile	Limit profile
Pre-heating	150°C to 180°C/90 s±30 s	150°C to 180°C/90 s±30 s
Heating	Above 220°C/30 s to 60 s	Above 230°C/60 s max.
Peak temperature	245°C±3°C	260°C/10 s
Number of reflow cycles	2 times	2 times

12.4 Reworking with soldering iron

The following requirements must be met to rework a soldered product using a soldering iron.

Item	Requirement
Pre-heating	150°C/approx. 1 min
Tip temperature of soldering iron	350°C max.
Power consumption of soldering iron	80 W max.
Tip diameter of soldering iron	ø3 mm max.
Soldering time	3 s (+1 s, -0 s)
Number of reworking operations	2 times max.
* Avoid a direct contact of the tip of the soldering iron with the product. Such a direction contact may cause cracks in the ceramic body due to thermal shock.	

12.5 Solder volume

Solder shall be used not to increase the volume too much.



$$\frac{1}{3} T \leq t \leq \frac{1}{2} T$$

T: thickness of product

An increased solder volume increases mechanical stress on the product. Exceeding solder volume may cause the failure of mechanical or electrical performance.

12.6 Product's location

The following shall be considered when designing and laying out PCBs.

(1) PCB shall be designed so that products are not subject to mechanical stress due to warping the board.

[Products direction]

Products shall be located in the sideways direction (length: $a < b$) to the mechanical stress.

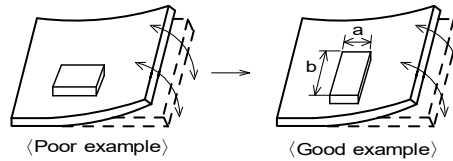

(2) Components location on PCB separation

It is effective to implement the following measures, to reduce stress in separating the board.

It is best to implement all of the following three measures; however, implement as many measures as possible to reduce stress.

Contents of measures	Stress level
(1) Turn the mounting direction of the component parallel to the board separation surface.	$A > D^{*1}$
(2) Add slits in the board separation part.	$A > B$
(3) Keep the mounting position of the component away from the board separation surface.	$A > C$
*1 $A > D$ is valid when stress is added vertically to the perforation as with hand separation. If a cutting disc is used, stress will be diagonal to the PCB, therefore $A > D$ is invalid.	

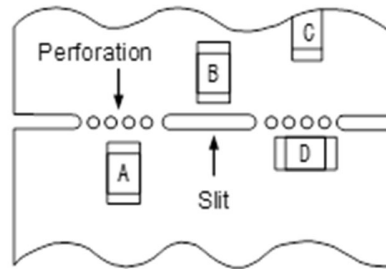

(3) Mounting components near screw holes

When a component is mounted near a screw hole, it may be affected by the board deflection that occurs during the tightening of the screw.

Mount the component in a position as far away from the screw holes as possible.

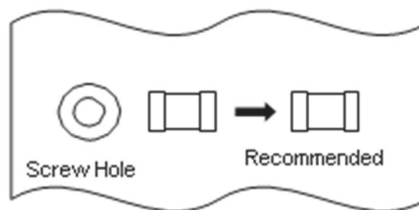

12.7 Handling of substrate

(1) The stress applied to the chip varies depending on the material and construction of the mounted substrate.

If the coefficients of thermal expansion for the substrate and chip vary significantly, the difference in thermal expansion and shrinkage could cause cracks to form in the chip.

We assume that the products are mounted on glass-epoxy substrate. Assessment has not been conducted on substrates where the coefficient of thermal expansion varies significantly from glass-epoxy substrates. If mounting on these substrates, be sure to conduct full assessments before use.

(2) After mounting products on a substrate, do not apply any stress to the product caused by bending or twisting to the substrate when cropping the substrate, inserting and removing a connector from the substrate or tightening screw to the substrate.

Excessive mechanical stress may cause cracking in the product.

Also, if mounting on flexible substrates, excessive mechanical stress could be applied to the chip by even slight bending or twisting when handling this substrate, and so please conduct full assessments before use.

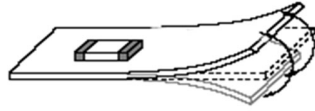

Bending

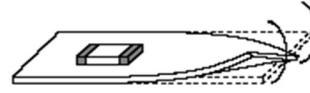

Twisting

12.8 Cleaning

The product shall be cleaned under the following conditions.

(1) The cleaning temperature shall be 60°C max. If isopropyl alcohol (IPA) is used, the cleaning temperature shall be 40°C max.

(2) Perform ultrasonic cleaning under the following conditions. Exercise caution to prevent resonance phenomenon in mounted products and the PCB.

Item	Requirement
Power	20 W/L max.
Time	5 min max.
Frequency	28 kHz to 40 kHz

(3) Cleaner

Alcohol-based cleaner: IPA

Aqueous agent: PINE ALPHA ST-100S

(4) There shall be no residual flux or residual cleaner. When using aqueous agent, rinse the product with deionized water adequately and completely dry it so that no cleaner is left.

* For other cleaning, consult our technical department.

12.9 Storage and transportation

Storage period	Use the product within 12 months after delivery. If you do not use the product for more than 12 months, check solderability before using it.
Storage conditions	<ul style="list-style-type: none"> The products shall be stored in a room not subject to rapid changes in temperature and humidity. The recommended temperature range is -10°C to +40°C. The recommended relative humidity range is 15% to 85%. Keeping the product in corrosive gases, such as sulfur, chlorine gas or acid may cause the poor solderability. Do not place the products directly on the floor; they should be placed on a palette so that they are not affected by humidity or dust. Avoid keeping the products in a place exposed to direct sunlight, heat or vibration. Do not keep products in bulk packaging. Bulk storage could result in collisions between the products or between the products and other parts, resulting in chipping or wire breakage. Avoid storing the product by itself bare (i.e. exposed directly to air).
Transportation	Excessive vibration and impact reduces the reliability of the products. Exercise caution when handling the products.

12.10 Resin coating (including moisture-proof coating)

Before applying any resin coating, please consult our technical department.

12.11 Mounting conditions

Check the mounting condition before using.

Using mounting conditions (nozzles, equipment conditions, etc.) that are not suitable for products may lead to pick up errors, misalignment, or damage to the product.

12.12 Operating environment

Do not use this product under the following environmental conditions as it may cause deterioration of product quality.

(1) In the corrodible atmosphere such as acidic gases, alkaline gases, chlorine, sulfur gases, organic gases and etc. (the sea breeze, Cl₂, H₂S, NH₃, SO₂, NO₂, etc)

(2) In the atmosphere where liquid such as organic solvent, may splash on the products.

(3) In the atmosphere where the temperature/humidity changes rapidly and it is easy to dew.

12.13 Mounting density

If this product is placed near heat-generating products, be sure to implement sufficient heat-dissipating measures.

If this product is subjected to a significant amount of heat from other products, this could adversely affect product quality, resulting in a circuit malfunction or failure of the mounted section. Also, be sure that the product is used in a manner so that the heat that the product is subjected to from other products does not exceed the upper limit of the rated operating temperature for the product.

13. ⚠Note

- (1) Please make sure that your product has been evaluated in view of your specifications with our product being mounted to your product.
- (2) You are requested not to use our product deviating from the reference specifications.
- (3) The contents of this reference specification are subject to change without advance notice. Please approve our product specifications or transact the approval sheet for product specifications before ordering.

Appendix

Electrical performance: Measuring method for inductance/Q (Q measurement is applicable only when the Q value is included in the rating table.)

Perform measurement using the method described below. (Perform correction for the error deriving from the measuring terminal.)

(1) Residual elements and stray elements of the measuring terminal can be expressed by the F parameter for the 2-pole terminal as shown in the figure below.

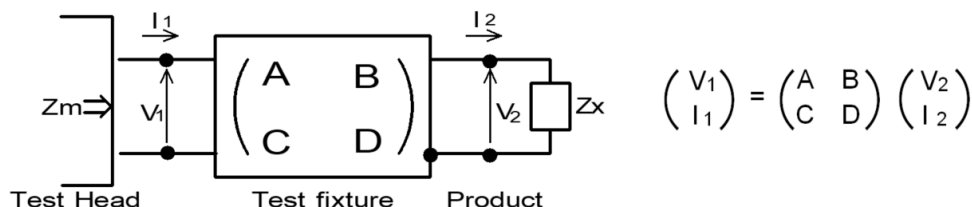

(2) The product's impedance value (Z_x) and measured impedance value (Z_m) can be expressed as shown below, by using the respective current and voltage for input/output.

$$Z_m = \frac{V_1}{I_1} \quad Z_x = \frac{V_2}{I_2}$$

(3) Thus, the relationship between the product's impedance value (Z_x) and measured impedance value (Z_m) is as follows.

$Z_x = \alpha \frac{Z_m - \beta}{1 - Z_m \Gamma}$	<p>Here,</p> <p>$\alpha = D/A = 1$</p> <p>$\beta = B/D = Z_{sm} - (1 - Y_{om} Z_{sm}) Z_{ss}$</p> <p>$\Gamma = C/A = Y_{om}$</p> <p>$Z_{sm}$: measured impedance of short chip</p> <p>Z_{ss}: residual impedance of short chip (0.480 nH)</p> <p>Y_{om}: measured admittance when measuring terminal is open</p>
---	--

(4) Calculate inductance L_x and Q_x using the equations shown below.

$L_x = \frac{\text{Im}(Z_x)}{2\pi f}$	<p>L_x: inductance of chip coil</p>
$Q_x = \frac{\text{Im}(Z_x)}{\text{Re}(Z_x)}$	<p>Q_x: Q of chip coil</p> <p>f: measuring frequency</p>

单击下面可查看定价，库存，交付和生命周期等信息

[>>Murata\(村田\)](#)