

CHIP COILS (CHIP INDUCTORS) LQP02HQ□□□□02□ REFERENCE SPECIFICATION

1. Scope

This reference applies to chip coils (chip inductors) LQP02HQ_02 series for general electronic equipment.

2. Part Numbering

(Ex.) LQ	P	02	H	Q	0N2	W	0	2	L
Product ID	Structure	Dimension (L × W)	Application and characteristic	Category	Inductance	Tolerance	Performance	Electrode specification	Packaging L: 4 mm width /plastic tape E: 8 mm width /plastic tape *B: bulk

*B: Bulk packing is also available (taping condition: however, products without reels are put in plastic bags).

3. Part Number and Rating

Operating temperature range	-55°C to +125°C
Storage temperature range	-55°C to +125°C

Customer Part number	Murata Part number	Inductance		Q (Min.)	DC resistance (Ω max.)	Self-resonant frequency (GHz)		Rated current (mA)
		Nominal value (nH)	Tolerance			*Typical value	Lower limit	
	LQP02HQ0N2W02L	0.2	W: ±0.05 nH	-	0.01	>20	17.0	1000
	LQP02HQ0N2W02E	0.2	W: ±0.05 nH	-	0.01	>20	17.0	1000
	LQP02HQ0N2B02L	0.2	B: ±0.1 nH	-	0.01	>20	17.0	1000
	LQP02HQ0N2B02E	0.2	B: ±0.1 nH	-	0.01	>20	17.0	1000
	LQP02HQ0N2C02L	0.2	C: ±0.2 nH	-	0.01	>20	17.0	1000
	LQP02HQ0N2C02E	0.2	C: ±0.2 nH	-	0.01	>20	17.0	1000
	LQP02HQ0N3W02L	0.3	W: ±0.05 nH	-	0.02	>20	17.0	1000
	LQP02HQ0N3W02E	0.3	W: ±0.05 nH	-	0.02	>20	17.0	1000
	LQP02HQ0N3B02L	0.3	B: ±0.1 nH	-	0.02	>20	17.0	1000
	LQP02HQ0N3B02E	0.3	B: ±0.1 nH	-	0.02	>20	17.0	1000
	LQP02HQ0N3C02L	0.3	C: ±0.2 nH	-	0.02	>20	17.0	1000
	LQP02HQ0N3C02E	0.3	C: ±0.2 nH	-	0.02	>20	17.0	1000
	LQP02HQ0N4W02L	0.4	W: ±0.05 nH	14	0.03	>20	17.0	1000
	LQP02HQ0N4W02E	0.4	W: ±0.05 nH	14	0.03	>20	17.0	1000
	LQP02HQ0N4B02L	0.4	B: ±0.1 nH	14	0.03	>20	17.0	1000
	LQP02HQ0N4B02E	0.4	B: ±0.1 nH	14	0.03	>20	17.0	1000
	LQP02HQ0N4C02L	0.4	C: ±0.2 nH	14	0.03	>20	17.0	1000
	LQP02HQ0N4C02E	0.4	C: ±0.2 nH	14	0.03	>20	17.0	1000
	LQP02HQ0N5W02L	0.5	W: ±0.05 nH	14	0.04	>20	17.0	1000
	LQP02HQ0N5W02E	0.5	W: ±0.05 nH	14	0.04	>20	17.0	1000
	LQP02HQ0N5B02L	0.5	B: ±0.1 nH	14	0.04	>20	17.0	1000
	LQP02HQ0N5B02E	0.5	B: ±0.1 nH	14	0.04	>20	17.0	1000
	LQP02HQ0N5C02L	0.5	C: ±0.2 nH	14	0.04	>20	17.0	1000
	LQP02HQ0N5C02E	0.5	C: ±0.2 nH	14	0.04	>20	17.0	1000
	LQP02HQ0N6W02L	0.6	W: ±0.05 nH	14	0.05	>20	17.0	950
	LQP02HQ0N6W02E	0.6	W: ±0.05 nH	14	0.05	>20	17.0	950
	LQP02HQ0N6B02L	0.6	B: ±0.1 nH	14	0.05	>20	17.0	950

MURATA MFG CO., LTD

Customer Part number	Murata Part number	Inductance		Q (Min.)	DC resistance (Ω max.)	Self-resonant frequency (GHz)		Rated current (mA)
		Nominal value (nH)	Tolerance			*Typical value	Lower limit	
	LQP02HQ0N6B02E	0.6	B: ± 0.1 nH	14	0.05	>20	17.0	950
	LQP02HQ0N6C02L	0.6	C: ± 0.2 nH	14	0.05	>20	17.0	950
	LQP02HQ0N6C02E	0.6	C: ± 0.2 nH	14	0.05	>20	17.0	950
	LQP02HQ0N7W02L	0.7	W: ± 0.05 nH	14	0.05	19	15.5	900
	LQP02HQ0N7W02E	0.7	W: ± 0.05 nH	14	0.05	19	15.5	900
	LQP02HQ0N7B02L	0.7	B: ± 0.1 nH	14	0.05	19	15.5	900
	LQP02HQ0N7B02E	0.7	B: ± 0.1 nH	14	0.05	19	15.5	900
	LQP02HQ0N7C02L	0.7	C: ± 0.2 nH	14	0.05	19	15.5	900
	LQP02HQ0N7C02E	0.7	C: ± 0.2 nH	14	0.05	19	15.5	900
	LQP02HQ0N8W02L	0.8	W: ± 0.05 nH	14	0.05	19	15.5	900
	LQP02HQ0N8W02E	0.8	W: ± 0.05 nH	14	0.05	19	15.5	900
	LQP02HQ0N8B02L	0.8	B: ± 0.1 nH	14	0.05	19	15.5	900
	LQP02HQ0N8B02E	0.8	B: ± 0.1 nH	14	0.05	19	15.5	900
	LQP02HQ0N8C02L	0.8	C: ± 0.2 nH	14	0.05	19	15.5	900
	LQP02HQ0N8C02E	0.8	C: ± 0.2 nH	14	0.05	19	15.5	900
	LQP02HQ0N9W02L	0.9	W: ± 0.05 nH	14	0.05	19	14.6	900
	LQP02HQ0N9W02E	0.9	W: ± 0.05 nH	14	0.05	19	14.6	900
	LQP02HQ0N9B02L	0.9	B: ± 0.1 nH	14	0.05	19	14.6	900
	LQP02HQ0N9B02E	0.9	B: ± 0.1 nH	14	0.05	19	14.6	900
	LQP02HQ0N9C02L	0.9	C: ± 0.2 nH	14	0.05	19	14.6	900
	LQP02HQ0N9C02E	0.9	C: ± 0.2 nH	14	0.05	19	14.6	900
	LQP02HQ1N0W02L	1.0	W: ± 0.05 nH	14	0.05	18	13.2	900
	LQP02HQ1N0W02E	1.0	W: ± 0.05 nH	14	0.05	18	13.2	900
	LQP02HQ1N0B02L	1.0	B: ± 0.1 nH	14	0.05	18	13.2	900
	LQP02HQ1N0B02E	1.0	B: ± 0.1 nH	14	0.05	18	13.2	900
	LQP02HQ1N0C02L	1.0	C: ± 0.2 nH	14	0.05	18	13.2	900
	LQP02HQ1N0C02E	1.0	C: ± 0.2 nH	14	0.05	18	13.2	900
	LQP02HQ1N1W02L	1.1	W: ± 0.05 nH	14	0.06	16	12.8	850
	LQP02HQ1N1W02E	1.1	W: ± 0.05 nH	14	0.06	16	12.8	850
	LQP02HQ1N1B02L	1.1	B: ± 0.1 nH	14	0.06	16	12.8	850
	LQP02HQ1N1B02E	1.1	B: ± 0.1 nH	14	0.06	16	12.8	850
	LQP02HQ1N1C02L	1.1	C: ± 0.2 nH	14	0.06	16	12.8	850
	LQP02HQ1N1C02E	1.1	C: ± 0.2 nH	14	0.06	16	12.8	850
	LQP02HQ1N2W02L	1.2	W: ± 0.05 nH	14	0.06	15	12.8	800
	LQP02HQ1N2W02E	1.2	W: ± 0.05 nH	14	0.06	15	12.8	800
	LQP02HQ1N2B02L	1.2	B: ± 0.1 nH	14	0.06	15	12.8	800
	LQP02HQ1N2B02E	1.2	B: ± 0.1 nH	14	0.06	15	12.8	800
	LQP02HQ1N2C02L	1.2	C: ± 0.2 nH	14	0.06	15	12.8	800
	LQP02HQ1N2C02E	1.2	C: ± 0.2 nH	14	0.06	15	12.8	800
	LQP02HQ1N3W02L	1.3	W: ± 0.05 nH	14	0.08	15	12.7	700
	LQP02HQ1N3W02E	1.3	W: ± 0.05 nH	14	0.08	15	12.7	700
	LQP02HQ1N3B02L	1.3	B: ± 0.1 nH	14	0.08	15	12.7	700
	LQP02HQ1N3B02E	1.3	B: ± 0.1 nH	14	0.08	15	12.7	700
	LQP02HQ1N3C02L	1.3	C: ± 0.2 nH	14	0.08	15	12.7	700

Customer Part number	Murata Part number	Inductance		Q (Min.)	DC resistance (Ω max.)	Self-resonant frequency (GHz)		Rated current (mA)
		Nominal value (nH)	Tolerance			*Typical value	Lower limit	
	LQP02HQ1N3C02E	1.3	C: ± 0.2 nH	14	0.08	15	12.7	700
	LQP02HQ1N4W02L	1.4	W: ± 0.05 nH	14	0.08	14.5	12.7	700
	LQP02HQ1N4W02E	1.4	W: ± 0.05 nH	14	0.08	14.5	12.7	700
	LQP02HQ1N4B02L	1.4	B: ± 0.1 nH	14	0.08	14.5	12.7	700
	LQP02HQ1N4B02E	1.4	B: ± 0.1 nH	14	0.08	14.5	12.7	700
	LQP02HQ1N4C02L	1.4	C: ± 0.2 nH	14	0.08	14.5	12.7	700
	LQP02HQ1N4C02E	1.4	C: ± 0.2 nH	14	0.08	14.5	12.7	700
	LQP02HQ1N5W02L	1.5	W: ± 0.05 nH	14	0.08	14	12.7	700
	LQP02HQ1N5W02E	1.5	W: ± 0.05 nH	14	0.08	14	12.7	700
	LQP02HQ1N5B02L	1.5	B: ± 0.1 nH	14	0.08	14	12.7	700
	LQP02HQ1N5B02E	1.5	B: ± 0.1 nH	14	0.08	14	12.7	700
	LQP02HQ1N5C02L	1.5	C: ± 0.2 nH	14	0.08	14	12.7	700
	LQP02HQ1N5C02E	1.5	C: ± 0.2 nH	14	0.08	14	12.7	700
	LQP02HQ1N6W02L	1.6	W: ± 0.05 nH	14	0.08	14	10.7	700
	LQP02HQ1N6W02E	1.6	W: ± 0.05 nH	14	0.08	14	10.7	700
	LQP02HQ1N6B02L	1.6	B: ± 0.1 nH	14	0.08	14	10.7	700
	LQP02HQ1N6B02E	1.6	B: ± 0.1 nH	14	0.08	14	10.7	700
	LQP02HQ1N6C02L	1.6	C: ± 0.2 nH	14	0.08	14	10.7	700
	LQP02HQ1N6C02E	1.6	C: ± 0.2 nH	14	0.08	14	10.7	700
	LQP02HQ1N7W02L	1.7	W: ± 0.05 nH	14	0.08	14	10.7	700
	LQP02HQ1N7W02E	1.7	W: ± 0.05 nH	14	0.08	14	10.7	700
	LQP02HQ1N7B02L	1.7	B: ± 0.1 nH	14	0.08	14	10.7	700
	LQP02HQ1N7B02E	1.7	B: ± 0.1 nH	14	0.08	14	10.7	700
	LQP02HQ1N7C02L	1.7	C: ± 0.2 nH	14	0.08	14	10.7	700
	LQP02HQ1N7C02E	1.7	C: ± 0.2 nH	14	0.08	14	10.7	700
	LQP02HQ1N8W02L	1.8	W: ± 0.05 nH	14	0.08	13.5	10.2	700
	LQP02HQ1N8W02E	1.8	W: ± 0.05 nH	14	0.08	13.5	10.2	700
	LQP02HQ1N8B02L	1.8	B: ± 0.1 nH	14	0.08	13.5	10.2	700
	LQP02HQ1N8B02E	1.8	B: ± 0.1 nH	14	0.08	13.5	10.2	700
	LQP02HQ1N8C02L	1.8	C: ± 0.2 nH	14	0.08	13.5	10.2	700
	LQP02HQ1N8C02E	1.8	C: ± 0.2 nH	14	0.08	13.5	10.2	700
	LQP02HQ1N9W02L	1.9	W: ± 0.05 nH	14	0.08	12.5	10.2	700
	LQP02HQ1N9W02E	1.9	W: ± 0.05 nH	14	0.08	12.5	10.2	700
	LQP02HQ1N9B02L	1.9	B: ± 0.1 nH	14	0.08	12.5	10.2	700
	LQP02HQ1N9B02E	1.9	B: ± 0.1 nH	14	0.08	12.5	10.2	700
	LQP02HQ1N9C02L	1.9	C: ± 0.2 nH	14	0.08	12.5	10.2	700
	LQP02HQ1N9C02E	1.9	C: ± 0.2 nH	14	0.08	12.5	10.2	700
	LQP02HQ2N0W02L	2.0	W: ± 0.05 nH	14	0.1	11.5	10.1	700
	LQP02HQ2N0W02E	2.0	W: ± 0.05 nH	14	0.1	11.5	10.1	700
	LQP02HQ2N0B02L	2.0	B: ± 0.1 nH	14	0.1	11.5	10.1	700
	LQP02HQ2N0B02E	2.0	B: ± 0.1 nH	14	0.1	11.5	10.1	700
	LQP02HQ2N0C02L	2.0	C: ± 0.2 nH	14	0.1	11.5	10.1	700
	LQP02HQ2N0C02E	2.0	C: ± 0.2 nH	14	0.1	11.5	10.1	700
	LQP02HQ2N1W02L	2.1	W: ± 0.05 nH	14	0.1	11.5	10.1	650

Customer Part number	Murata Part number	Inductance		Q (Min.)	DC resistance (Ω max.)	Self-resonant frequency (GHz)		Rated current (mA)
		Nominal value (nH)	Tolerance			*Typical value	Lower limit	
	LQP02HQ2N1W02E	2.1	W: ± 0.05 nH	14	0.1	11.5	10.1	650
	LQP02HQ2N1B02L	2.1	B: ± 0.1 nH	14	0.1	11.5	10.1	650
	LQP02HQ2N1B02E	2.1	B: ± 0.1 nH	14	0.1	11.5	10.1	650
	LQP02HQ2N1C02L	2.1	C: ± 0.2 nH	14	0.1	11.5	10.1	650
	LQP02HQ2N1C02E	2.1	C: ± 0.2 nH	14	0.1	11.5	10.1	650
	LQP02HQ2N2W02L	2.2	W: ± 0.05 nH	14	0.2	11.5	9.8	500
	LQP02HQ2N2W02E	2.2	W: ± 0.05 nH	14	0.2	11.5	9.8	500
	LQP02HQ2N2B02L	2.2	B: ± 0.1 nH	14	0.2	11.5	9.8	500
	LQP02HQ2N2B02E	2.2	B: ± 0.1 nH	14	0.2	11.5	9.8	500
	LQP02HQ2N2C02L	2.2	C: ± 0.2 nH	14	0.2	11.5	9.8	500
	LQP02HQ2N2C02E	2.2	C: ± 0.2 nH	14	0.2	11.5	9.8	500
	LQP02HQ2N3W02L	2.3	W: ± 0.05 nH	14	0.2	11	9.8	450
	LQP02HQ2N3W02E	2.3	W: ± 0.05 nH	14	0.2	11	9.8	450
	LQP02HQ2N3B02L	2.3	B: ± 0.1 nH	14	0.2	11	9.8	450
	LQP02HQ2N3B02E	2.3	B: ± 0.1 nH	14	0.2	11	9.8	450
	LQP02HQ2N3C02L	2.3	C: ± 0.2 nH	14	0.2	11	9.8	450
	LQP02HQ2N3C02E	2.3	C: ± 0.2 nH	14	0.2	11	9.8	450
	LQP02HQ2N4W02L	2.4	W: ± 0.05 nH	14	0.2	11	9.5	450
	LQP02HQ2N4W02E	2.4	W: ± 0.05 nH	14	0.2	11	9.5	450
	LQP02HQ2N4B02L	2.4	B: ± 0.1 nH	14	0.2	11	9.5	450
	LQP02HQ2N4B02E	2.4	B: ± 0.1 nH	14	0.2	11	9.5	450
	LQP02HQ2N4C02L	2.4	C: ± 0.2 nH	14	0.2	11	9.5	450
	LQP02HQ2N4C02E	2.4	C: ± 0.2 nH	14	0.2	11	9.5	450
	LQP02HQ2N5W02L	2.5	W: ± 0.05 nH	14	0.2	11	9.5	450
	LQP02HQ2N5W02E	2.5	W: ± 0.05 nH	14	0.2	11	9.5	450
	LQP02HQ2N5B02L	2.5	B: ± 0.1 nH	14	0.2	11	9.5	450
	LQP02HQ2N5B02E	2.5	B: ± 0.1 nH	14	0.2	11	9.5	450
	LQP02HQ2N5C02L	2.5	C: ± 0.2 nH	14	0.2	11	9.5	450
	LQP02HQ2N5C02E	2.5	C: ± 0.2 nH	14	0.2	11	9.5	450
	LQP02HQ2N6B02L	2.6	B: ± 0.1 nH	14	0.2	11	9.5	450
	LQP02HQ2N6B02E	2.6	B: ± 0.1 nH	14	0.2	11	9.5	450
	LQP02HQ2N6C02L	2.6	C: ± 0.2 nH	14	0.2	11	9.5	450
	LQP02HQ2N6C02E	2.6	C: ± 0.2 nH	14	0.2	11	9.5	450
	LQP02HQ2N7B02L	2.7	B: ± 0.1 nH	14	0.2	10.5	8.8	450
	LQP02HQ2N7B02E	2.7	B: ± 0.1 nH	14	0.2	10.5	8.8	450
	LQP02HQ2N7C02L	2.7	C: ± 0.2 nH	14	0.2	10.5	8.8	450
	LQP02HQ2N7C02E	2.7	C: ± 0.2 nH	14	0.2	10.5	8.8	450
	LQP02HQ2N8B02L	2.8	B: ± 0.1 nH	14	0.2	10.5	8.8	450
	LQP02HQ2N8B02E	2.8	B: ± 0.1 nH	14	0.2	10.5	8.8	450
	LQP02HQ2N8C02L	2.8	C: ± 0.2 nH	14	0.2	10.5	8.8	450
	LQP02HQ2N8C02E	2.8	C: ± 0.2 nH	14	0.2	10.5	8.8	450
	LQP02HQ2N9B02L	2.9	B: ± 0.1 nH	14	0.2	10.5	8.8	450
	LQP02HQ2N9B02E	2.9	B: ± 0.1 nH	14	0.2	10.5	8.8	450
	LQP02HQ2N9C02L	2.9	C: ± 0.2 nH	14	0.2	10.5	8.8	450

Customer Part number	Murata Part number	Inductance		Q (Min.)	DC resistance (Ω max.)	Self-resonant frequency (GHz)		Rated current (mA)
		Nominal value (nH)	Tolerance			*Typical value	Lower limit	
	LQP02HQ2N9C02E	2.9	C: ± 0.2 nH	14	0.2	10.5	8.8	450
	LQP02HQ3N0B02L	3.0	B: ± 0.1 nH	14	0.2	10	8.5	450
	LQP02HQ3N0B02E	3.0	B: ± 0.1 nH	14	0.2	10	8.5	450
	LQP02HQ3N0C02L	3.0	C: ± 0.2 nH	14	0.2	10	8.5	450
	LQP02HQ3N0C02E	3.0	C: ± 0.2 nH	14	0.2	10	8.5	450
	LQP02HQ3N1B02L	3.1	B: ± 0.1 nH	14	0.25	10	8.5	400
	LQP02HQ3N1B02E	3.1	B: ± 0.1 nH	14	0.25	10	8.5	400
	LQP02HQ3N1C02L	3.1	C: ± 0.2 nH	14	0.25	10	8.5	400
	LQP02HQ3N1C02E	3.1	C: ± 0.2 nH	14	0.25	10	8.5	400
	LQP02HQ3N2B02L	3.2	B: ± 0.1 nH	14	0.25	10	8.5	400
	LQP02HQ3N2B02E	3.2	B: ± 0.1 nH	14	0.25	10	8.5	400
	LQP02HQ3N2C02L	3.2	C: ± 0.2 nH	14	0.25	10	8.5	400
	LQP02HQ3N2C02E	3.2	C: ± 0.2 nH	14	0.25	10	8.5	400
	LQP02HQ3N3B02L	3.3	B: ± 0.1 nH	14	0.25	10	8.2	400
	LQP02HQ3N3B02E	3.3	B: ± 0.1 nH	14	0.25	10	8.2	400
	LQP02HQ3N3C02L	3.3	C: ± 0.2 nH	14	0.25	10	8.2	400
	LQP02HQ3N3C02E	3.3	C: ± 0.2 nH	14	0.25	10	8.2	400
	LQP02HQ3N4B02L	3.4	B: ± 0.1 nH	14	0.3	10	8.2	400
	LQP02HQ3N4B02E	3.4	B: ± 0.1 nH	14	0.3	10	8.2	400
	LQP02HQ3N4C02L	3.4	C: ± 0.2 nH	14	0.3	10	8.2	400
	LQP02HQ3N4C02E	3.4	C: ± 0.2 nH	14	0.3	10	8.2	400
	LQP02HQ3N5B02L	3.5	B: ± 0.1 nH	14	0.3	10	8.2	350
	LQP02HQ3N5B02E	3.5	B: ± 0.1 nH	14	0.3	10	8.2	350
	LQP02HQ3N5C02L	3.5	C: ± 0.2 nH	14	0.3	10	8.2	350
	LQP02HQ3N5C02E	3.5	C: ± 0.2 nH	14	0.3	10	8.2	350
	LQP02HQ3N6B02L	3.6	B: ± 0.1 nH	14	0.3	9.5	8.2	350
	LQP02HQ3N6B02E	3.6	B: ± 0.1 nH	14	0.3	9.5	8.2	350
	LQP02HQ3N6C02L	3.6	C: ± 0.2 nH	14	0.3	9.5	8.2	350
	LQP02HQ3N6C02E	3.6	C: ± 0.2 nH	14	0.3	9.5	8.2	350
	LQP02HQ3N7B02L	3.7	B: ± 0.1 nH	14	0.35	9.5	8.2	350
	LQP02HQ3N7B02E	3.7	B: ± 0.1 nH	14	0.35	9.5	8.2	350
	LQP02HQ3N7C02L	3.7	C: ± 0.2 nH	14	0.35	9.5	8.2	350
	LQP02HQ3N7C02E	3.7	C: ± 0.2 nH	14	0.35	9.5	8.2	350
	LQP02HQ3N8B02L	3.8	B: ± 0.1 nH	14	0.35	9.5	8.2	350
	LQP02HQ3N8B02E	3.8	B: ± 0.1 nH	14	0.35	9.5	8.2	350
	LQP02HQ3N8C02L	3.8	C: ± 0.2 nH	14	0.35	9.5	8.2	350
	LQP02HQ3N8C02E	3.8	C: ± 0.2 nH	14	0.35	9.5	8.2	350
	LQP02HQ3N9B02L	3.9	B: ± 0.1 nH	14	0.35	9.5	7.7	350
	LQP02HQ3N9B02E	3.9	B: ± 0.1 nH	14	0.35	9.5	7.7	350
	LQP02HQ3N9C02L	3.9	C: ± 0.2 nH	14	0.35	9.5	7.7	350
	LQP02HQ3N9C02E	3.9	C: ± 0.2 nH	14	0.35	9.5	7.7	350
	LQP02HQ4N0B02L	4.0	B: ± 0.1 nH	14	0.35	9	6.9	350
	LQP02HQ4N0B02E	4.0	B: ± 0.1 nH	14	0.35	9	6.9	350
	LQP02HQ4N0C02L	4.0	C: ± 0.2 nH	14	0.35	9	6.9	350

Customer Part number	Murata Part number	Inductance		Q (Min.)	DC resistance (Ω max.)	Self-resonant frequency (GHz)		Rated current (mA)
		Nominal value (nH)	Tolerance			*Typical value	Lower limit	
	LQP02HQ4N0C02E	4.0	C: ± 0.2 nH	14	0.35	9	6.9	350
	LQP02HQ4N1B02L	4.1	B: ± 0.1 nH	14	0.35	9	6.9	350
	LQP02HQ4N1B02E	4.1	B: ± 0.1 nH	14	0.35	9	6.9	350
	LQP02HQ4N1C02L	4.1	C: ± 0.2 nH	14	0.35	9	6.9	350
	LQP02HQ4N1C02E	4.1	C: ± 0.2 nH	14	0.35	9	6.9	350
	LQP02HQ4N2B02L	4.2	B: ± 0.1 nH	14	0.35	8	6.9	350
	LQP02HQ4N2B02E	4.2	B: ± 0.1 nH	14	0.35	8	6.9	350
	LQP02HQ4N2C02L	4.2	C: ± 0.2 nH	14	0.35	8	6.9	350
	LQP02HQ4N2C02E	4.2	C: ± 0.2 nH	14	0.35	8	6.9	350
	LQP02HQ4N3H02L	4.3	H: $\pm 3\%$	13	0.35	8	6.9	350
	LQP02HQ4N3H02E	4.3	H: $\pm 3\%$	13	0.35	8	6.9	350
	LQP02HQ4N3J02L	4.3	J: $\pm 5\%$	13	0.35	8	6.9	350
	LQP02HQ4N3J02E	4.3	J: $\pm 5\%$	13	0.35	8	6.9	350
	LQP02HQ4N7H02L	4.7	H: $\pm 3\%$	13	0.35	8	6.7	350
	LQP02HQ4N7H02E	4.7	H: $\pm 3\%$	13	0.35	8	6.7	350
	LQP02HQ4N7J02L	4.7	J: $\pm 5\%$	13	0.35	8	6.7	350
	LQP02HQ4N7J02E	4.7	J: $\pm 5\%$	13	0.35	8	6.7	350
	LQP02HQ5N1H02L	5.1	H: $\pm 3\%$	13	0.35	8	6.6	350
	LQP02HQ5N1H02E	5.1	H: $\pm 3\%$	13	0.35	8	6.6	350
	LQP02HQ5N1J02L	5.1	J: $\pm 5\%$	13	0.35	8	6.6	350
	LQP02HQ5N1J02E	5.1	J: $\pm 5\%$	13	0.35	8	6.6	350
	LQP02HQ5N6H02L	5.6	H: $\pm 3\%$	13	0.4	7.5	6.1	300
	LQP02HQ5N6H02E	5.6	H: $\pm 3\%$	13	0.4	7.5	6.1	300
	LQP02HQ5N6J02L	5.6	J: $\pm 5\%$	13	0.4	7.5	6.1	300
	LQP02HQ5N6J02E	5.6	J: $\pm 5\%$	13	0.4	7.5	6.1	300
	LQP02HQ6N2H02L	6.2	H: $\pm 3\%$	13	0.4	7.0	6.0	300
	LQP02HQ6N2H02E	6.2	H: $\pm 3\%$	13	0.4	7.0	6.0	300
	LQP02HQ6N2J02L	6.2	J: $\pm 5\%$	13	0.4	7.0	6.0	300
	LQP02HQ6N2J02E	6.2	J: $\pm 5\%$	13	0.4	7.0	6.0	300
	LQP02HQ6N8H02L	6.8	H: $\pm 3\%$	13	0.4	7.0	5.7	300
	LQP02HQ6N8H02E	6.8	H: $\pm 3\%$	13	0.4	7.0	5.7	300
	LQP02HQ6N8J02L	6.8	J: $\pm 5\%$	13	0.4	7.0	5.7	300
	LQP02HQ6N8J02E	6.8	J: $\pm 5\%$	13	0.4	7.0	5.7	300
	LQP02HQ7N5H02L	7.5	H: $\pm 3\%$	13	0.5	6.5	5.6	300
	LQP02HQ7N5H02E	7.5	H: $\pm 3\%$	13	0.5	6.5	5.6	300
	LQP02HQ7N5J02L	7.5	J: $\pm 5\%$	13	0.5	6.5	5.6	300
	LQP02HQ7N5J02E	7.5	J: $\pm 5\%$	13	0.5	6.5	5.6	300
	LQP02HQ8N2H02L	8.2	H: $\pm 3\%$	13	0.5	6.5	5.1	300
	LQP02HQ8N2H02E	8.2	H: $\pm 3\%$	13	0.5	6.5	5.1	300
	LQP02HQ8N2J02L	8.2	J: $\pm 5\%$	13	0.5	6.5	5.1	300
	LQP02HQ8N2J02E	8.2	J: $\pm 5\%$	13	0.5	6.5	5.1	300
	LQP02HQ9N1H02L	9.1	H: $\pm 3\%$	13	0.5	6.0	4.9	300
	LQP02HQ9N1H02E	9.1	H: $\pm 3\%$	13	0.5	6.0	4.9	300
	LQP02HQ9N1J02L	9.1	J: $\pm 5\%$	13	0.5	6.0	4.9	300

Customer Part number	Murata Part number	Inductance		Q (Min.)	DC resistance (Ω max.)	Self-resonant frequency (GHz)		Rated current (mA)
		Nominal value (nH)	Tolerance			*Typical value	Lower limit	
	LQP02HQ9N1J02E	9.1	J: $\pm 5\%$	13	0.5	6.0	4.9	300
	LQP02HQ10NH02L	10	H: $\pm 3\%$	13	0.6	5.8	4.9	250
	LQP02HQ10NH02E	10	H: $\pm 3\%$	13	0.6	5.8	4.9	250
	LQP02HQ10NJ02L	10	J: $\pm 5\%$	13	0.6	5.8	4.9	250
	LQP02HQ10NJ02E	10	J: $\pm 5\%$	13	0.6	5.8	4.9	250
	LQP02HQ11NH02L	11	H: $\pm 3\%$	13	0.8	5.6	4.0	250
	LQP02HQ11NH02E	11	H: $\pm 3\%$	13	0.8	5.6	4.0	250
	LQP02HQ11NJ02L	11	J: $\pm 5\%$	13	0.8	5.6	4.0	250
	LQP02HQ11NJ02E	11	J: $\pm 5\%$	13	0.8	5.6	4.0	250
	LQP02HQ12NH02L	12	H: $\pm 3\%$	13	0.82	5.6	4.0	230
	LQP02HQ12NH02E	12	H: $\pm 3\%$	13	0.82	5.6	4.0	230
	LQP02HQ12NJ02L	12	J: $\pm 5\%$	13	0.82	5.6	4.0	230
	LQP02HQ12NJ02E	12	J: $\pm 5\%$	13	0.82	5.6	4.0	230
	LQP02HQ13NH02L	13	H: $\pm 3\%$	13	0.99	4.8	4.0	210
	LQP02HQ13NH02E	13	H: $\pm 3\%$	13	0.99	4.8	4.0	210
	LQP02HQ13NJ02L	13	J: $\pm 5\%$	13	0.99	4.8	4.0	210
	LQP02HQ13NJ02E	13	J: $\pm 5\%$	13	0.99	4.8	4.0	210
	LQP02HQ15NH02L	15	H: $\pm 3\%$	13	1.53	4.8	4.0	170
	LQP02HQ15NH02E	15	H: $\pm 3\%$	13	1.53	4.8	4.0	170
	LQP02HQ15NJ02L	15	J: $\pm 5\%$	13	1.53	4.8	4.0	170
	LQP02HQ15NJ02E	15	J: $\pm 5\%$	13	1.53	4.8	4.0	170
	LQP02HQ16NH02L	16	H: $\pm 3\%$	13	1.53	4.4	4.0	170
	LQP02HQ16NH02E	16	H: $\pm 3\%$	13	1.53	4.4	4.0	170
	LQP02HQ16NJ02L	16	J: $\pm 5\%$	13	1.53	4.4	4.0	170
	LQP02HQ16NJ02E	16	J: $\pm 5\%$	13	1.53	4.4	4.0	170
	LQP02HQ18NH02L	18	H: $\pm 3\%$	13	1.63	4.2	3.7	160
	LQP02HQ18NH02E	18	H: $\pm 3\%$	13	1.63	4.2	3.7	160
	LQP02HQ18NJ02L	18	J: $\pm 5\%$	13	1.63	4.2	3.7	160
	LQP02HQ18NJ02E	18	J: $\pm 5\%$	13	1.63	4.2	3.7	160
	LQP02HQ20NH02L	20	H: $\pm 3\%$	12	2.26	3.9	3.0	140
	LQP02HQ20NH02E	20	H: $\pm 3\%$	12	2.26	3.9	3.0	140
	LQP02HQ20NJ02L	20	J: $\pm 5\%$	12	2.26	3.9	3.0	140
	LQP02HQ20NJ02E	20	J: $\pm 5\%$	12	2.26	3.9	3.0	140
	LQP02HQ22NH02L	22	H: $\pm 3\%$	12	2.26	3.9	3.0	140
	LQP02HQ22NH02E	22	H: $\pm 3\%$	12	2.26	3.9	3.0	140
	LQP02HQ22NJ02L	22	J: $\pm 5\%$	12	2.26	3.9	3.0	140
	LQP02HQ22NJ02E	22	J: $\pm 5\%$	12	2.26	3.9	3.0	140
	LQP02HQ24NH02L	24	H: $\pm 3\%$	12	2.6	3.7	2.9	120
	LQP02HQ24NH02E	24	H: $\pm 3\%$	12	2.6	3.7	2.9	120
	LQP02HQ24NJ02L	24	J: $\pm 5\%$	12	2.6	3.7	2.9	120
	LQP02HQ24NJ02E	24	J: $\pm 5\%$	12	2.6	3.7	2.9	120
	LQP02HQ27NH02L	27	H: $\pm 3\%$	12	2.6	3.6	2.9	120
	LQP02HQ27NH02E	27	H: $\pm 3\%$	12	2.6	3.6	2.9	120
	LQP02HQ27NJ02L	27	J: $\pm 5\%$	12	2.6	3.6	2.9	120

Customer Part number	Murata Part number	Inductance		Q (Min.)	DC resistance (Ω max.)	Self-resonant frequency (GHz)		Rated current (mA)
		Nominal value (nH)	Tolerance			*Typical value	Lower limit	
	LQP02HQ27NJ02E	27	J: $\pm 5\%$	12	2.6	3.6	2.9	120
	LQP02HQ30NH02L	30	H: $\pm 3\%$	9	3.2	3.4	2.6	120
	LQP02HQ30NH02E	30	H: $\pm 3\%$	9	3.2	3.4	2.6	120
	LQP02HQ30NJ02L	30	J: $\pm 5\%$	9	3.2	3.4	2.6	120
	LQP02HQ30NJ02E	30	J: $\pm 5\%$	9	3.2	3.4	2.6	120
	LQP02HQ33NH02L	33	H: $\pm 3\%$	9	3.2	3.2	2.6	120
	LQP02HQ33NH02E	33	H: $\pm 3\%$	9	3.2	3.2	2.6	120
	LQP02HQ33NJ02L	33	J: $\pm 5\%$	9	3.2	3.2	2.6	120
	LQP02HQ33NJ02E	33	J: $\pm 5\%$	9	3.2	3.2	2.6	120
	LQP02HQ36NH02L	36	H: $\pm 3\%$	9	3.6	3.1	2.4	110
	LQP02HQ36NH02E	36	H: $\pm 3\%$	9	3.6	3.1	2.4	110
	LQP02HQ36NJ02L	36	J: $\pm 5\%$	9	3.6	3.1	2.4	110
	LQP02HQ36NJ02E	36	J: $\pm 5\%$	9	3.6	3.1	2.4	110
	LQP02HQ39NH02L	39	H: $\pm 3\%$	9	3.6	3.0	2.4	110
	LQP02HQ39NH02E	39	H: $\pm 3\%$	9	3.6	3.0	2.4	110
	LQP02HQ39NJ02L	39	J: $\pm 5\%$	9	3.6	3.0	2.4	110
	LQP02HQ39NJ02E	39	J: $\pm 5\%$	9	3.6	3.0	2.4	110
	LQP02HQ43NH02L	43	H: $\pm 3\%$	8	4.0	2.7	2.1	100
	LQP02HQ43NH02E	43	H: $\pm 3\%$	8	4.0	2.7	2.1	100
	LQP02HQ43NJ02L	43	J: $\pm 5\%$	8	4.0	2.7	2.1	100
	LQP02HQ43NJ02E	43	J: $\pm 5\%$	8	4.0	2.7	2.1	100
	LQP02HQ47NH02L	47	H: $\pm 3\%$	8	4.0	2.6	2.1	100
	LQP02HQ47NH02E	47	H: $\pm 3\%$	8	4.0	2.6	2.1	100
	LQP02HQ47NJ02L	47	J: $\pm 5\%$	8	4.0	2.6	2.1	100
	LQP02HQ47NJ02E	47	J: $\pm 5\%$	8	4.0	2.6	2.1	100
	LQP02HQ51NH02L	51	H: $\pm 3\%$	8	4.2	2.5	1.9	100
	LQP02HQ51NH02E	51	H: $\pm 3\%$	8	4.2	2.5	1.9	100
	LQP02HQ51NJ02L	51	J: $\pm 5\%$	8	4.2	2.5	1.9	100
	LQP02HQ51NJ02E	51	J: $\pm 5\%$	8	4.2	2.5	1.9	100
	LQP02HQ56NH02L	56	H: $\pm 3\%$	8	4.2	2.3	1.9	100
	LQP02HQ56NH02E	56	H: $\pm 3\%$	8	4.2	2.3	1.9	100
	LQP02HQ56NJ02L	56	J: $\pm 5\%$	8	4.2	2.3	1.9	100
	LQP02HQ56NJ02E	56	J: $\pm 5\%$	8	4.2	2.3	1.9	100

* Typical value is actual performance.

4. Testing Conditions

Unless otherwise specified	Temperature: ordinary temperature (15°C to 35°C) Humidity: ordinary humidity [25% to 85% (RH)]
In case of doubt	Temperature: 20°C \pm 2°C Humidity: 60% to 70% (RH) Atmospheric pressure: 86 kPa to 106 kPa

5. Appearance and Dimensions

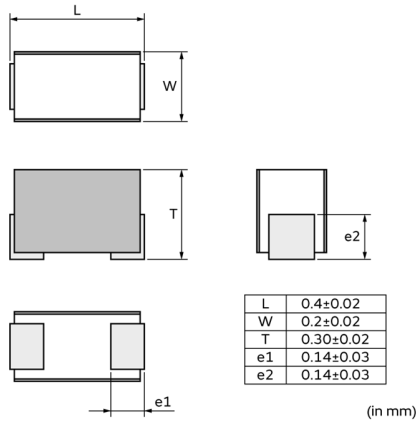

Unit mass (typical value): 0.085 mg

6. Marking

Side surface identification marking :blue

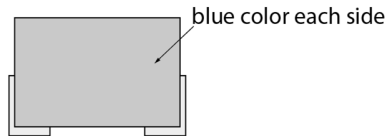

7. Electrical Performance

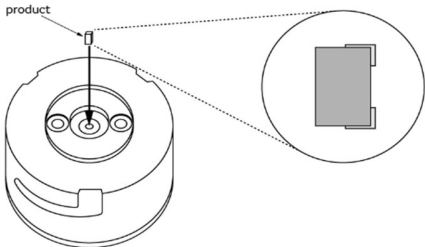
No.	Item	Specification	Test method				
7.1	Inductance	Meet chapter 3 ratings.	Measuring equipment: Keysight E4991A or the equivalent Measuring frequency: <table border="1"> <tr> <td>500 MHz</td> <td>0.2 nH to 30 nH</td> </tr> <tr> <td>300 MHz</td> <td>33 nH to 56 nH</td> </tr> </table> Measuring conditions: Measurement signal level: Approx. 0 dBm Electrical length: 27.3 mm Measuring fixture: Keysight 16196D Position the chip coil under test as shown in the measuring example below and connect it to the electrode by applying weight. Measurement example: 	500 MHz	0.2 nH to 30 nH	300 MHz	33 nH to 56 nH
500 MHz	0.2 nH to 30 nH						
300 MHz	33 nH to 56 nH						
7.2	Q	Meet chapter 3 ratings.					

Product insertion hole: $\phi 0.36$ mm
 Measuring method: see "Electrical performance: Measuring method for inductance/Q" in the Appendix.

No.	Item	Specification	Test method
7.3	DC resistance	Meet chapter 3 ratings.	Measuring equipment: digital multimeter
7.4	Self-resonant frequency	Meet chapter 3 ratings.	Measuring equipment: Keysight N5230A or the equivalent
7.5	Rated current	Product temperature rise: 25°C max.	Apply the rated current specified in chapter 3.

8. Mechanical Performance

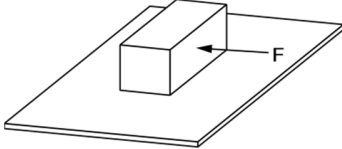
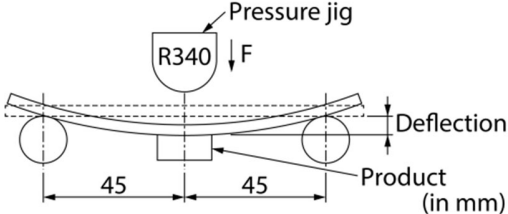
No.	Item	Specification	Test method
8.1	Shear test	No significant mechanical damage or no sign of electrode peeling off shall be observed.	<p>Test substrate: glass-epoxy substrate Applying force: 1 N Holding time: 5 s\pm1 s Force application direction:</p> 
8.2	Bending test	No significant mechanical damage or no sign of electrode peeling off shall be observed.	<p>Test substrate: glass-epoxy substrate (100 mm \times 40 mm \times 0.8 mm) Pressurizing speed: 1 mm/s Pressure jig: R340 Deflection: 1 mm Holding time: 30 s</p> 
8.3	Vibration	Appearance shall have no significant mechanical damage. Inductance change rate: within \pm 10%	<p>Oscillation frequency: 10 Hz to 2000 Hz to 10 Hz, for approx. 20 min Total amplitude: total amplitude of 1.5 mm or acceleration amplitude of 196 m/s², whichever is smaller Test time: 3 directions perpendicular to each other, 2 h for each direction (6 h in total)</p>
8.4	Solderability	90% or more of the outer electrode shall be covered with new solder seamlessly.	<p>Flux: immersed in ethanol solution with a rosin content of 25(wt)% for 5 s to 10 s Solder: Sn-3.0Ag-0.5Cu solder Pre-heating: 150°C\pm10°C/60 s to 90 s Solder temperature: 240°C\pm5°C Immersion time: 3 s\pm1 s</p>
8.5	Resistance to soldering heat	Appearance: No significant mechanical damage shall be observed. Inductance change rate: within \pm 10%	<p>Flux: immersed in ethanol solution with a rosin content of 25(wt)% for 5 s to 10 s Solder: Sn-3.0Ag-0.5Cu solder Pre-heating: 150°C\pm10°C/60 s to 90 s Solder temperature: 260°C\pm5°C Immersion time: 5 s\pm1 s Post-treatment: left at a room condition for 24 h\pm2 h</p>

9. Environmental Performance

The product is soldered on a glass-epoxy substrate for test.

No.	Item	Specification	Test method
9.1	Heat resistance	Appearance: No significant mechanical damage shall be observed. Inductance change rate: within \pm 10%	<p>Temperature: 125°C\pm2°C Test time: 1000 h (+48 h, -0 h) Post-treatment: left at a room condition for 24 h\pm2 h</p>
9.2	Cold resistance	Appearance: No significant mechanical damage shall be observed. Inductance change rate: within \pm 10%	<p>Temperature: -55°C\pm3°C Test time: 1000 h (+48 h, -0 h) Post-treatment: left at a room condition for 24 h\pm2 h</p>

No.	Item	Specification	Test method
9.3	Humidity	Appearance: No significant mechanical damage shall be observed. Inductance change rate: within $\pm 10\%$	Temperature: $40^{\circ}\text{C} \pm 2^{\circ}\text{C}$ Humidity: 90% (RH) to 95% (RH) Test time: 1000 h (+48 h, -0 h) Post-treatment: left at a room condition for $24 \text{ h} \pm 2 \text{ h}$
9.4	Temperature cycle	Appearance: No significant mechanical damage shall be observed. Inductance change rate: within $\pm 10\%$	Single cycle conditions: Step 1: $-55^{\circ}\text{C} \pm 2^{\circ}\text{C} / 30 \text{ min} \pm 3 \text{ min}$ Step 2: ordinary temperature / 10 min to 15 min Step 3: $+125^{\circ}\text{C} \pm 2^{\circ}\text{C} / 30 \text{ min} \pm 3 \text{ min}$ Step 4: ordinary temperature / 10 min to 15 min Number of testing: 10 cycles Post-treatment: left at a room condition for $24 \text{ h} \pm 2 \text{ h}$

10. Specification of Packaging

10.1 Appearance and dimensions of tape

- 8 mm width/plastic tape

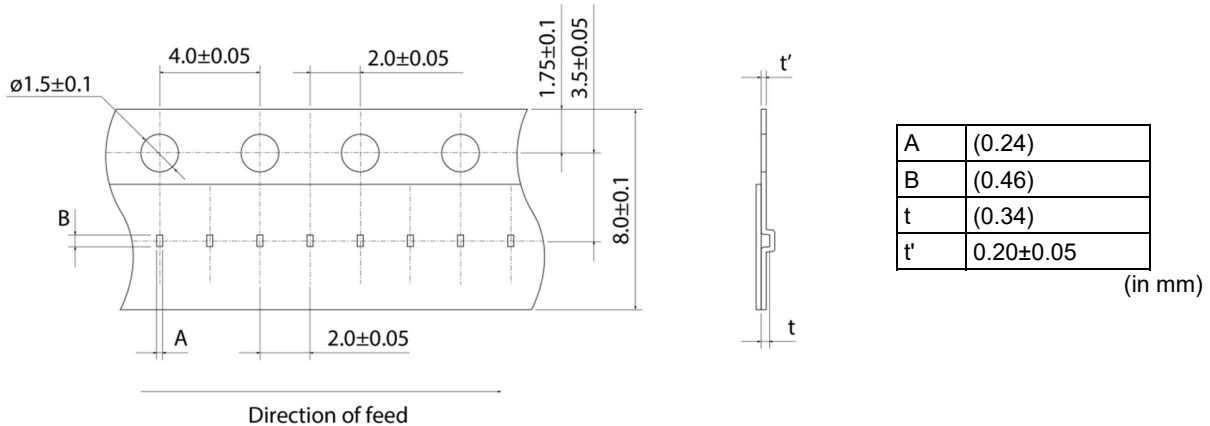

- * The dimensions of the cavity are measured at its bottom.
- 4 mm width/plastic tape

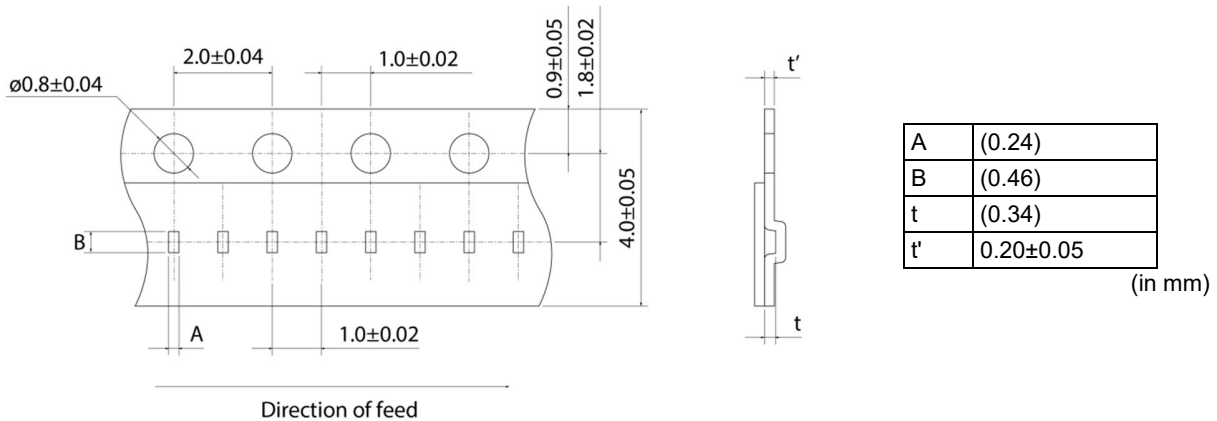

- * The dimensions of the cavity are measured at its bottom.

■ Top view

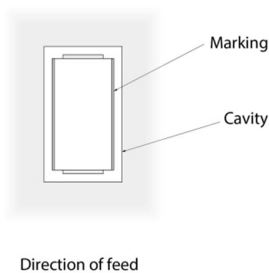

10.2 Taping specifications

Packing quantity (Standard quantity)	15000 pcs/reel (carrier tape: 8 mm width, 2 mm pitch) 30000 pcs/reel (carrier tape: 4 mm width, 1 mm pitch)
Packing method	The products are placed in cavities of a carrier tape and sealed by a cover tape (top tape and bottom tape when the cavities of the carrier tape are punched type).
Feed hole position	The feed holes on the carrier tape are on the right side when the cover tape (top tape when the cavities of the carrier tape are punched type) is pulled toward the user.
Joint	The carrier tape and cover tape (top tape when the cavities of the carrier tape are punched type) are seamless.
Number of missing products	Number of missing products within 0.1% of the number per reel or 1 pc., whichever is greater, and are not continuous. The specified quantity per reel is kept.

10.3 Break down force of tape

Cover tape (or top tape)	5 N min.
Bottom tape (only when the cavities of the carrier tape are punched type)	5 N min.

10.4 Peeling off force of tape

Speed of peeling off	300 mm/min
Peeling off force	0.1 N to 0.6 N (The lower limit is for typical value.)

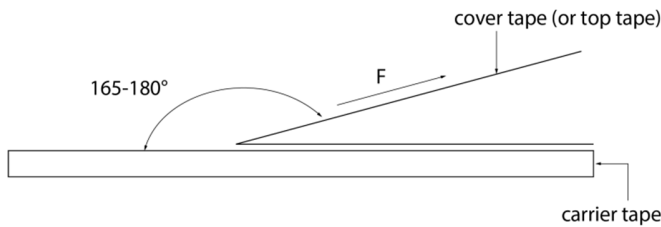

10.5 Dimensions of leader section, trailer section and reel

A vacant section is provided in the leader (start) section and trailer (end) section of the tape for the product. The leader section is further provided with an area consisting only of the cover tape (or top tape). (See the diagram below.)

- 8 mm width carrier tape

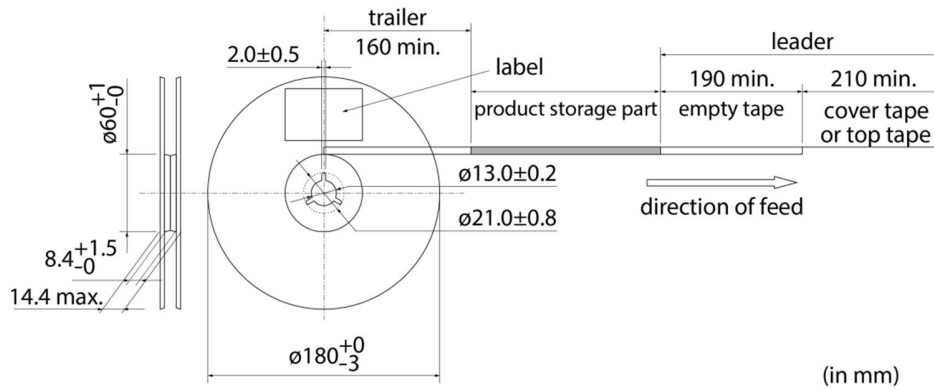

- 4 mm width carrier tape

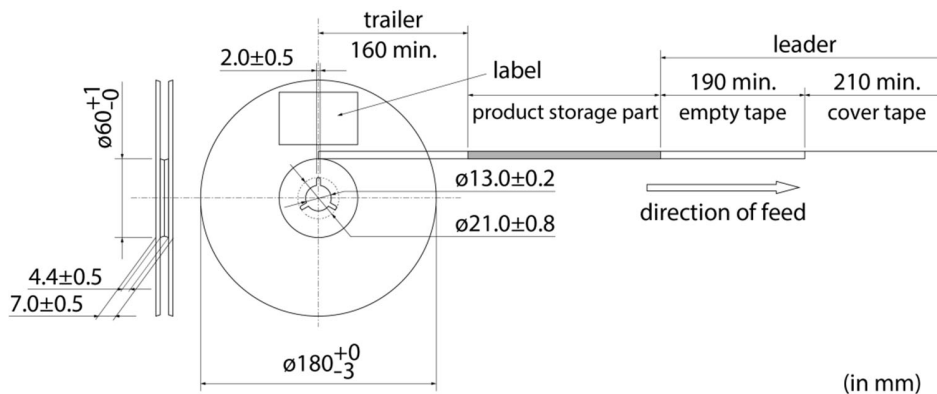

10.6 Marking for reel

Customer part number, Murata part number, inspection number (*1), RoHS marking (*2), quantity, etc.

<p>*1 Expression of inspection No.:</p> <table style="width: 100%; text-align: center;"> <tr> <td style="border: 1px solid black; padding: 2px;">□□</td> <td style="border: 1px solid black; padding: 2px;">○○○○</td> <td style="border: 1px solid black; padding: 2px;">◇◇◇◇</td> </tr> <tr> <td>(1)</td> <td>(2)</td> <td>(3)</td> </tr> </table>	□□	○○○○	◇◇◇◇	(1)	(2)	(3)	<p>(1) Factory code (2) Date First digit: year/last digit of year Second digit: month/Jan. to Sep.→1 to 9, Oct. to Dec.→O, N, D Third, Fourth digit: day (3) Serial No.</p>
□□	○○○○	◇◇◇◇					
(1)	(2)	(3)					
<p>*2 Expression of RoHS marking:</p> <table style="width: 100%; text-align: center;"> <tr> <td style="border: 1px solid black; padding: 2px;">ROHS-</td> <td style="border: 1px solid black; padding: 2px;">Y</td> <td style="border: 1px solid black; padding: 2px;">(△)</td> </tr> <tr> <td></td> <td>(1)</td> <td>(2)</td> </tr> </table>	ROHS-	Y	(△)		(1)	(2)	<p>(1) RoHS regulation conformity (2) Murata classification number</p>
ROHS-	Y	(△)					
	(1)	(2)					

10.7 Marking on outer box (corrugated box)

Customer name, purchasing order number, customer part number, Murata part number, RoHS marking (*2), quantity, etc.

10.8 Specification of outer box

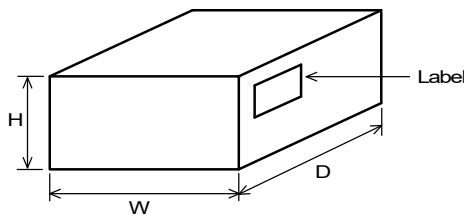

Dimensions of outer box (mm)			Tape width (mm)	Standard reel quantity in outer box(reel)
W	D	H		
186	186	93	4	10
			8	5
* Above outer box size is typical. It depends on a quantity of an order.				

11. ⚠Caution

11.1 Restricted applications

Please contact us before using our products for the applications listed below which require especially high reliability for the prevention of defects which might directly cause damage to the third party's life, body or property.

- | | | | |
|-------------------------------|---|------------------------------|---|
| (1) Aircraft equipment | (2) Aerospace equipment | (3) Undersea equipment | (4) Power plant control equipment |
| (5) Medical equipment | (6) Transportation equipment (vehicles, trains, ships, etc.) | (7) Traffic signal equipment | (8) Disaster/crime prevention equipment |
| (9) Data-processing equipment | (10) Applications of similar complexity and/or reliability requirements to the applications listed in the above | | |

11.2 Precautions on rating

Avoid using in exceeded the rated temperature range, rated voltage, or rated current. Usage when the ratings are exceeded could lead to wire breakage, burning, or other serious fault.

11.3 Inrush current

If an inrush current (or pulse current or rush current) that significantly exceeds the rated current is applied to the product, overheating could occur, resulting in wire breakage, burning, or other serious fault.

12. Precautions for Use

This product is for use only with reflow soldering. It is designed to be mounted by soldering. If you want to use other mounting method, for example, using a conductive adhesive, please consult us beforehand.

Also, if repeatedly subjected to temperature cycles or other thermal stress, due to the difference in the coefficient of thermal expansion with the mounting substrate, the solder (solder fillet part) in the mounting part may crack. The occurrence of cracks due to thermal stress is affected by the size of the land where mounted, the solder volume, and the heat dissipation of the mounting substrate. Carefully design it when a large change in ambient temperature is assumed.

12.1. Land dimensions

The following diagram shows the recommended land dimensions for reflow soldering:

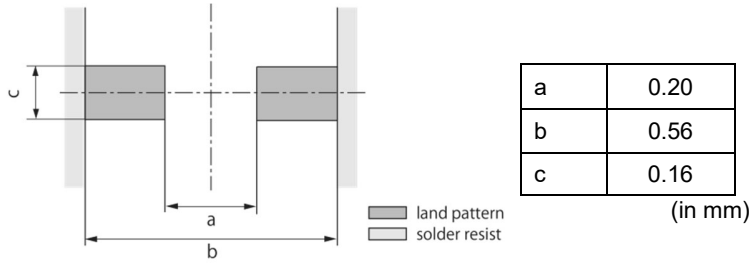

12.2 Flux and solder used

Flux	<ul style="list-style-type: none"> • Use a rosin-based flux. • Do not use a highly acidic flux with a halide content exceeding 0.2(wt)% (chlorine conversion value). • Do not use a water-soluble flux.
Solder	<ul style="list-style-type: none"> • Use Sn-3.0Ag-0.5Cu solder. • Standard thickness of solder paste: 50 μm to 65 μm

If you want to use a flux other than the above, please consult our technical department.

12.3 Soldering conditions (reflow)

- Pre-heating should be in such a way that the temperature difference between solder and product surface is limited to 150°C max.
Cooling into solvent after soldering also should be in such a way that the temperature difference is limited to 100°C max. Insufficient pre-heating may cause cracks on the product, resulting in the deterioration of product quality.
- Standard soldering profile and the limit soldering profile is as follows.
The excessive limit soldering conditions may cause leaching of the electrode and/or resulting in the deterioration of product quality.

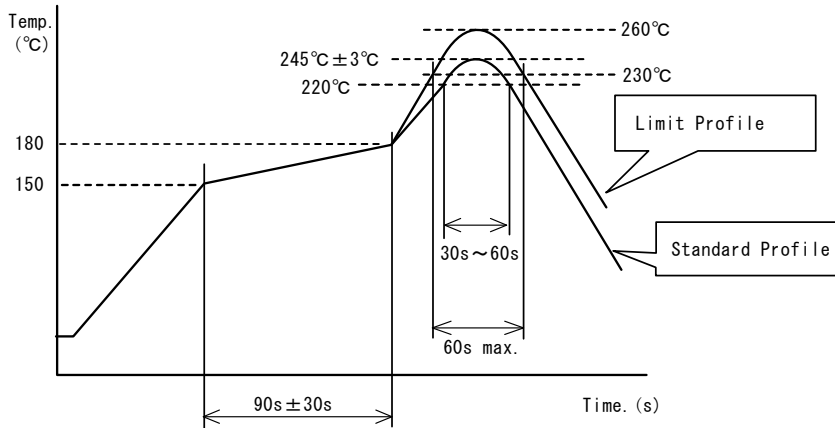

	Standard profile	Limit profile
Pre-heating	150°C to 180°C/90 s±30 s	150°C to 180°C/90 s±30 s
Heating	Above 220°C/30 s to 60 s	Above 230°C/60 s max.
Peak temperature	245°C±3°C	260°C/10 s
Number of reflow cycles	2 times	2 times

12.4 Reworking with soldering iron

Do not perform reworking with a soldering iron on this product.

12.5 Solder volume

Solder shall be used not to increase the volume too much.

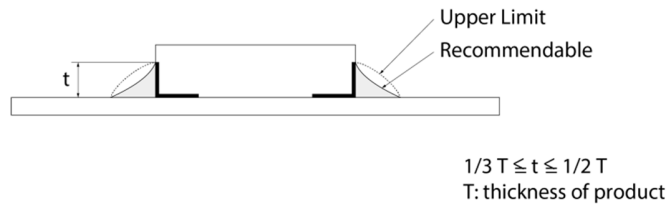

An increased solder volume increases mechanical stress on the product. Exceeding solder volume may cause the failure of mechanical or electrical performance.

12.6 Product's location

The following shall be considered when designing and laying out PCBs.

(1) PCB shall be designed so that products are not subject to mechanical stress due to warping the board.

[Products direction]

Products shall be located in the sideways direction (length: $a < b$) to the mechanical stress.

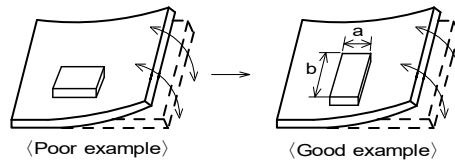

(2) Components location on PCB separation

It is effective to implement the following measures, to reduce stress in separating the board.

It is best to implement all of the following three measures; however, implement as many measures as possible to reduce stress.

Contents of measures	Stress level
(1) Turn the mounting direction of the component parallel to the board separation surface.	$A > D^{*1}$
(2) Add slits in the board separation part.	$A > B$
(3) Keep the mounting position of the component away from the board separation surface.	$A > C$
*1 $A > D$ is valid when stress is added vertically to the perforation as with hand separation. If a cutting disc is used, stress will be diagonal to the PCB, therefore $A > D$ is invalid.	

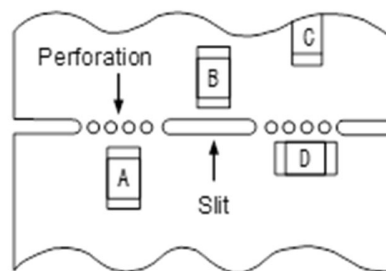

(3) Mounting components near screw holes

When a component is mounted near a screw hole, it may be affected by the board deflection that occurs during the tightening of the screw.

Mount the component in a position as far away from the screw holes as possible.

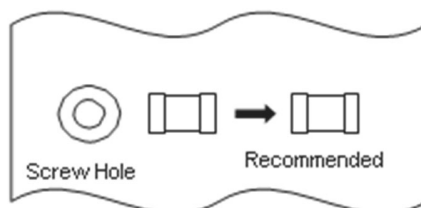

12.7 Handling of substrate

- (1) The stress applied to the chip varies depending on the material and construction of the mounted substrate.
 If the coefficients of thermal expansion for the substrate and chip vary significantly, the difference in thermal expansion and shrinkage could cause cracks to form in the chip.
 We assume that the products are mounted on glass-epoxy substrate. Assessment has not been conducted on substrates where the coefficient of thermal expansion varies significantly from glass-epoxy substrates. If mounting on these substrates, be sure to conduct full assessments before use.
- (2) After mounting products on a substrate, do not apply any stress to the product caused by bending or twisting to the substrate when cropping the substrate, inserting and removing a connector from the substrate or tightening screw to the substrate.
 Excessive mechanical stress may cause cracking in the product.
 Also, if mounting on flexible substrates, excessive mechanical stress could be applied to the chip by even slight bending or twisting when handling this substrate, and so please conduct full assessments before use.

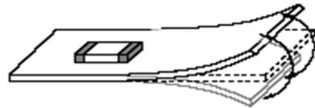

Bending

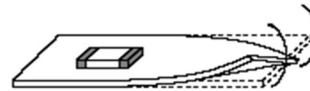

Twisting

12.8 Cleaning

- The product shall be cleaned under the following conditions.
- (1) The cleaning temperature shall be 60°C max. If isopropyl alcohol (IPA) is used, the cleaning temperature shall be 40°C max.
 - (2) Perform ultrasonic cleaning under the following conditions. Exercise caution to prevent resonance phenomenon in mounted products and the PCB.

Item	Requirement
Power	20 W/L max.
Time	5 min max.
Frequency	28 kHz to 40 kHz

- (3) Cleaner
 Alcohol-based cleaner: IPA
 Aqueous agent: PINE ALPHA ST-100S
 - (4) There shall be no residual flux or residual cleaner. When using aqueous agent, rinse the product with deionized water adequately and completely dry it so that no cleaner is left.
- * For other cleaning, consult our technical department.

12.9 Storage and transportation

Storage period	Use the product within 12 months after delivery. If you do not use the product for more than 12 months, check solderability before using it.
Storage conditions	<ul style="list-style-type: none"> • The products shall be stored in a room not subject to rapid changes in temperature and humidity. The recommended temperature range is -10°C to +40°C. The recommended relative humidity range is 15% to 85%. Keeping the product in corrosive gases, such as sulfur, chlorine gas or acid may cause the poor solderability. • Do not place the products directly on the floor; they should be placed on a palette so that they are not affected by humidity or dust. • Avoid keeping the products in a place exposed to direct sunlight, heat or vibration. • Do not keep products in bulk packaging. Bulk storage could result in collisions between the products or between the products and other parts, resulting in chipping or wire breakage. • Avoid storing the product by itself bare (i.e. exposed directly to air).
Transportation	Excessive vibration and impact reduces the reliability of the products. Exercise caution when handling the products.

12.10 Resin coating (including moisture-proof coating)

Before applying any resin coating, please consult our technical department.

12.11 Mounting conditions

Check the mounting condition before using.
 Using mounting conditions (nozzles, equipment conditions, etc.) that are not suitable for products may lead to pick up errors, misalignment, or damage to the product.

12.12 Operating environment

Do not use this product under the following environmental conditions as it may cause deterioration of product quality.

- (1) In the corrodible atmosphere such as acidic gases, alkaline gases, chlorine, sulfur gases, organic gases and etc.
(the sea breeze, Cl₂, H₂S, NH₃, SO₂, NO₂, etc)
- (2) In the atmosphere where liquid such as organic solvent, may splash on the products.
- (3) In the atmosphere where the temperature/humidity changes rapidly and it is easy to dew.

12.13 Mounting density

If this product is placed near heat-generating products, be sure to implement sufficient heat-dissipating measures.

If this product is subjected to a significant amount of heat from other products, this could adversely affect product quality, resulting in a circuit malfunction or failure of the mounted section. Also, be sure that the product is used in a manner so that the heat that the product is subjected to from other products does not exceed the upper limit of the rated operating temperature for the product.

13. Note

- (1) Please make sure that your product has been evaluated in view of your specifications with our product being mounted to your product.
- (2) You are requested not to use our product deviating from the reference specifications.
- (3) The contents of this reference specification are subject to change without advance notice. Please approve our product specifications or transact the approval sheet for product specifications before ordering.

Appendix

Electrical performance: Measuring method for inductance/Q (Q measurement is applicable only when the Q value is included in the rating table.)

Perform measurement using the method described below. (Perform correction for the error deriving from the measuring terminal.)

(1) Residual elements and stray elements of the measuring terminal can be expressed by the F parameter for the 2-pole terminal as shown in the figure below.

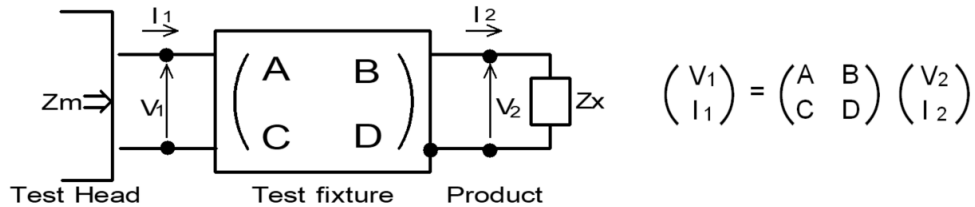

(2) The product's impedance value (Z_x) and measured impedance value (Z_m) can be expressed as shown below, by using the respective current and voltage for input/output.

$$Z_m = \frac{V_1}{I_1} \quad Z_x = \frac{V_2}{I_2}$$

(3) Thus, the relationship between the product's impedance value (Z_x) and measured impedance value (Z_m) is as follows.

$Z_x = \alpha \frac{Z_m - \beta}{1 - Z_m \Gamma}$	<p>Here,</p> <p>$\alpha = D/A = 1$</p> <p>$\beta = B/D = Z_{sm} - (1 - Y_{om} Z_{sm}) Z_{ss}$</p> <p>$\Gamma = C/A = Y_{om}$</p> <p>$Z_{sm}$: measured impedance of short chip</p> <p>Z_{ss}: residual impedance of short chip (0.110 nH)</p> <p>Y_{om}: measured admittance when measuring terminal is open</p>
---	--

(4) Calculate inductance L_x and Q_x using the equations shown below.

$L_x = \frac{\text{Im}(Z_x)}{2\pi f}$	<p>L_x: inductance of chip coil</p> <p>Q_x: Q of chip coil</p> <p>f: measuring frequency</p>
$Q_x = \frac{\text{Im}(Z_x)}{\text{Re}(Z_x)}$	

单击下面可查看定价，库存，交付和生命周期等信息

[>>Murata\(村田\)](#)