

**Wire Wound Chip Common Mode Choke Coil**

**DLW31SN□□□SQ2□**

**Reference Specification**

**1. Scope**

This reference specification applies to Chip Common Mode Choke Coil DLW31SN Series.

**2. Part Numbering**

(ex.)  $\frac{DL}{(1)} \frac{W}{(2)} \frac{31}{(3)} \frac{S}{(4)} \frac{N}{(5)} \frac{222}{(6)} \frac{S}{(7)} \frac{Q}{(8)} \frac{2}{(9)} \frac{L}{(10)}$

- (1) Chip Common Mode Choke Coil
- (2) Structure (W : Winding Type)
- (3) Dimension (L×W)
- (4) Type
- (5) Category
- (6) Impedance (Typ. at 100MHz)
- (7) Circuit
- (8) Features
- (9) Number of Line
- (10) Packaging Code L : Taping / B : Bulk

**3. Rating**

| Customer Part Number | Murata Part Number | Common Mode Impedance (at 100MHz, Under Standard Testing Condition) ( $\Omega \pm 25\%$ ) | Rated Voltage V(DC) | Withstanding Voltage V(DC) | Rated Current (mA) | DC Resistance ( $\Omega$ max.) | Insulation Resistance (M $\Omega$ min.) |
|----------------------|--------------------|---|---------------------|----------------------------|--------------------|--------------------------------|---|
|                      | DLW31SN222SQ2L     | 2200  | 50                  | 125                        | 200                | 1.2                            | 10                                      |
|                      | DLW31SN222SQ2B     |   |                     |                            | 230                | 1.0                            |   |
|                      | DLW31SN102SQ2L     | 1000  |                     |                            | 260                | 0.8                            |   |
|                      | DLW31SN102SQ2B     |   |                     |                            | 310                | 0.5                            |   |
|                      | DLW31SN601SQ2L     | 600   |                     |                            | 340                | 0.4                            |   |
|                      | DLW31SN601SQ2B     |   |                     |                            | 370                | 0.3                            |   |
|                      | DLW31SN261SQ2L     | 260   |                     |                            |                    |                                |   |
|                      | DLW31SN261SQ2B     |   |                     |                            |                    |                                |   |
|                      | DLW31SN161SQ2L     | 160   |                     |                            |                    |                                |   |
|                      | DLW31SN161SQ2B     |   |                     |                            |                    |                                |   |
|                      | DLW31SN900SQ2L     | 90  |                     |                            |                    |                                |   |
|                      | DLW31SN900SQ2B     |   |                     |                            |                    |                                |   |

Operating Temperature : -40 to +85°C Storage Temperature : -40 to +85°C

**4. Standard Testing Condition**

<Unless otherwise specified>

Temperature : Ordinary Temperature 15 to 35°C  
Humidity : Ordinary Humidity 25 to 85%(RH)

<In case of doubt>

Temperature : 20 ± 2°C  
Humidity : 60 to 70%(RH)  
Atmospheric Pressure : 86 to 106kPa

**5. Style and Dimensions**

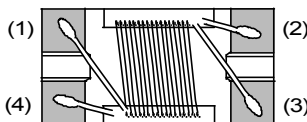
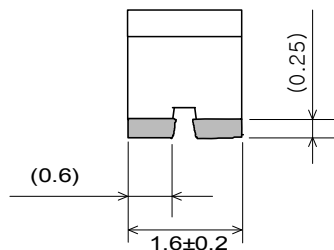
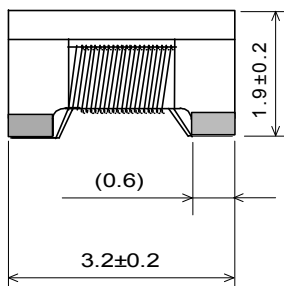

■ Electrode  
( ): Reference value  
(in mm)

**Equivalent Circuits**

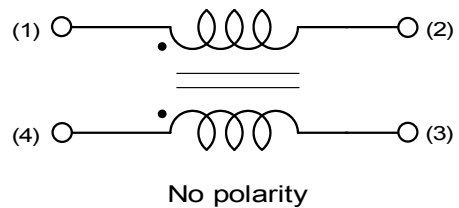

**Unit Mass (Typical value)**

0.039g

**6. Marking**

No Marking.

MURATA MFG.CO.,LTD

**7. Electrical Performance**

| No. | Item                         | Specification                  | Test Method   |
|-----|------------------------------|--------------------------------|---|
| 7.1 | Common Mode Impedance (Zc)   | Meet item 3.                   | Measuring Equipment : KEYSIGHT 4291A or the equivalent<br>Measuring Frequency : 100±1MHz(ref.item 10,11)                                    |
| 7.2 | Withstanding Voltage         | Products shall not be damaged. | Test Voltage : 2.5 times for Rated Voltage<br>Time : 1 to 5 seconds<br>Charge Current : 1 mA max. (ref.item 10)                             |
| 7.3 | DC Resistance (Rdc)          | Meet item 3.                   | Measuring current : 100mA max. (ref.item 10)<br>(In case of doubt in the above mentioned standard condition, measure by 4 terminal method.) |
| 7.4 | Insulation Resistance (I.R.) |                                | Measuring voltage : Rated Voltage<br>Measuring time : 1 minute max. (ref.item 10)   |

**8. Mechanical Performance**

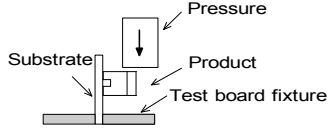
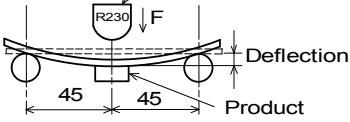
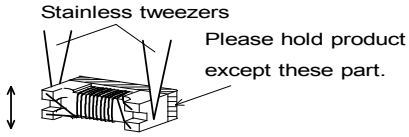
| No.                          | Item                         | Specification  | Test Method   |  |            |            |                              |             |      |           |   |
|------------------------------|------------------------------|--|---|--|------------|------------|------------------------------|-------------|------|-----------|---|
| 8.1                          | Appearance and Dimensions    | Meet item 5.   | Visual Inspection and measured with Slide Calipers.   |  |            |            |                              |             |      |           |   |
| 8.2                          | Bonding Strength             | No evidence of coming off substrate.<br>Products shall not be mechanical damaged.  | It shall be soldered on the substrate.<br>Applying Force(F) : 9.8N<br>Applying Time : 5±1 seconds<br>   |  |            |            |                              |             |      |           |   |
| 8.3                          | Bending Strength             | Meet Table 1.<br><br><table border="1" style="width: 100%;"> <thead> <tr> <th colspan="2">Table 1</th> </tr> </thead> <tbody> <tr> <td>Appearance</td> <td>No damaged</td> </tr> <tr> <td>Common Mode Impedance Change</td> <td>within ±20%</td> </tr> <tr> <td>I.R.</td> <td>10MΩ min.</td> </tr> </tbody> </table> | Table 1   |  | Appearance | No damaged | Common Mode Impedance Change | within ±20% | I.R. | 10MΩ min. | It shall be soldered on the Glass-epoxy substrate<br>Deflection : 2mm (t=1.0mm)<br>Keeping time : 30 seconds<br>Speed of Applying Force : 0.5mm/s<br>Pressure jig<br> |
| Table 1                      |                              |  |   |  |            |            |                              |             |      |           |   |
| Appearance                   | No damaged                   |  |   |  |            |            |                              |             |      |           |   |
| Common Mode Impedance Change | within ±20%                  |  |   |  |            |            |                              |             |      |           |   |
| I.R.                         | 10MΩ min.                    |  |   |  |            |            |                              |             |      |           |   |
| 8.4                          | Drop                         | Withstanding Voltage<br>No damaged   | It shall be dropped on concrete or steel board.<br>Method : free fall<br>Height : 75 cm<br>The Number of Times : 3 times  |  |            |            |                              |             |      |           |   |
| 8.5                          | Vibration                    |  | It shall be soldered on the substrate.<br>Oscillation Frequency : 10 to 55 to 10Hz for 1 minute<br>Total Amplitude : 1.5mm<br>Testing Time : A period of 2 hours in each of 3 mutually perpendicular directions. (Total 6 hours)  |  |            |            |                              |             |      |           |   |
| 8.6                          | Solderability                | The electrodes shall be at least 90% covered with new solder coating.  | Flux : Ethanol solution of rosin,25(wt)% includes activator equivalent to 0.06 to 0.10(wt)% chlorine<br>Pre-Heating : 80 to 120°C 1minute<br>Solder : Sn-3.0Ag-0.5Cu<br>Solder Temperature : 245±3°C<br>Immersion Time : 4±1 s<br>Immersion and emersion rates : 25mm / s<br> |  |            |            |                              |             |      |           |   |
| 8.7                          | Resistance to Soldering Heat | Meet Table 1.  | Flux : Ethanol solution of rosin,25(wt)% includes activator equipment to 0.06 to 0.10(wt)% chlorine<br>Pre-Heating : 80 to 120°C , 1minute<br>Solder : Sn-3.0Ag-0.5Cu<br>Solder Temperature : 260±5°C<br>Immersion Time : 5±0.5 seconds<br>Immersion and emersion rates : 25mm / s<br>Then measured after exposure in the room condition for 4 to 48 hours.       |  |            |            |                              |             |      |           |   |

**9. Environmental Performance**(Products shall be soldered on the substrate.)

| No. | Item              | Specification | Test Method   |
|-----|-------------------|---------------|---|
| 9.1 | Temperature Cycle | Meet Table 1. | 1 Cycle<br>Step 1 -40°C(+0°C,-3°C) / 30±3 min<br>Step 2 Ordinary Temp. / 10 to 15 minutes<br>Step 3 +85°C(+3°C,-0°C) / 30±3 min<br>Step 4 Ordinary Temp. / 10 to 15 minutes<br>Total of 10 cycles<br>Then measured after exposure in the room condition for 4 to 48 hours |
| 9.2 | Humidity          |               | Temperature : 40±2°C<br>Humidity : 90~95%(RH)<br>Time : 1000(+48 hours,-0 hours)<br>Then measured after exposure in the room condition for 4 to 48 hours.   |
| 9.3 | Heat life         |               | Temperature : 85±2°C<br>Applying Voltage : 2times for Rated Voltage<br>Time : 1000(+48 hours,-0 hours)<br>Then measured after exposure in the room condition for 4 to 48 hours.   |
| 9.4 | Cold Resistance   |               | Temperature : -40± 2°C<br>Time : 1000(+48 hours,-0 hours)<br>Then measured after exposure in the room condition for 4 to 48 hours.  |

**10. Terminal to be Tested.**

When measuring and supplying the voltage, the following terminal is applied.

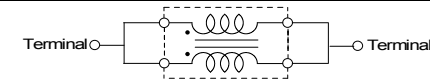
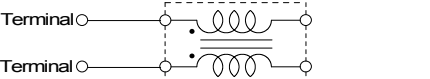
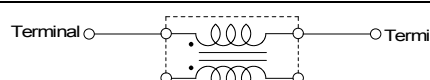
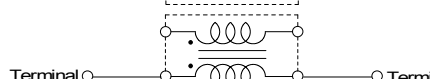
| No.  | Item   | Terminal to be Tested  |
|------|--|--|
| 10.1 | Common Mode Impedance (Measurement Terminal) |   |
| 10.2 | Withstanding Voltage (Measurement Terminal)  |  |
| 10.3 | DC Resistance (Measurement Terminal)         |  |
| 10.4 | Insulation Resistance (Measurement Terminal) |  |
| 10.5 | Heat Life(Supply Terminal)                   |  |

**11. Measuring method for common mode impedance.**

Measured common mode impedance may be included measurement error due to stray capacitance, residual inductance of test fixture.

To correct this error, the common mode impedance should be calculate as follows;

- (1) Measure admittance of the fixture(opened),  $G_o$   $B_o$ .
- (2) Measure impedance of the fixture(shorted),  $R_s$   $X_s$ .
- (3) Measure admittance of the specimen,  $G_m$   $B_m$ .
- (4) Calculate corrected impedance  $|Z|$  using the formula below.

$$|Z| = (R_x^2 + X_x^2)^{1/2}$$

Where

$$R_x = \frac{G_m - G_o}{(G_m - G_o)^2 + (B_m - B_o)^2} - R_s$$

$$X_x = \frac{-(B_m - B_o)}{(G_m - G_o)^2 + (B_m - B_o)^2} - X_s$$

**12. P.C.B., Flux, Solder and Soldering condition**

Test shall be done using P.C.B., Flux, Solder and Soldering condition which are specified in item 16 except the case of being specified special condition.

13. Impedance Frequency Characteristics(Typical)

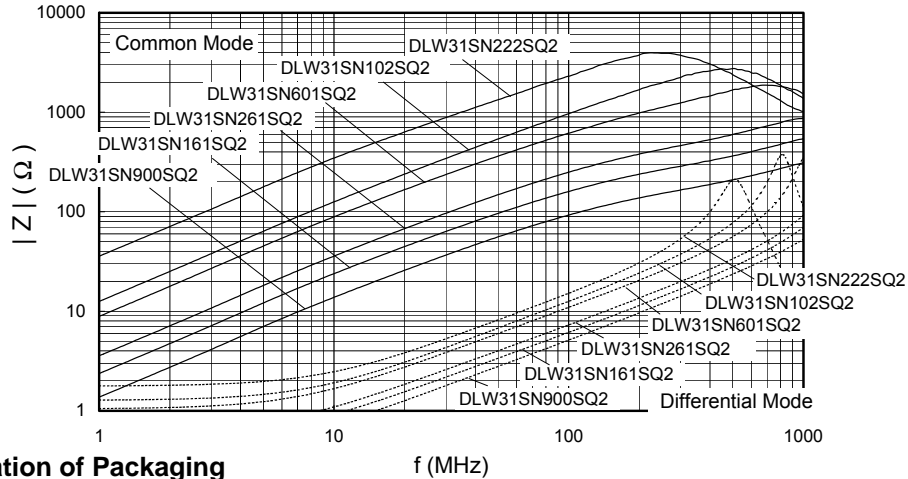

14. Specification of Packaging

14.1 Appearance and Dimensions ( 8mm-wide,Plastic tape)

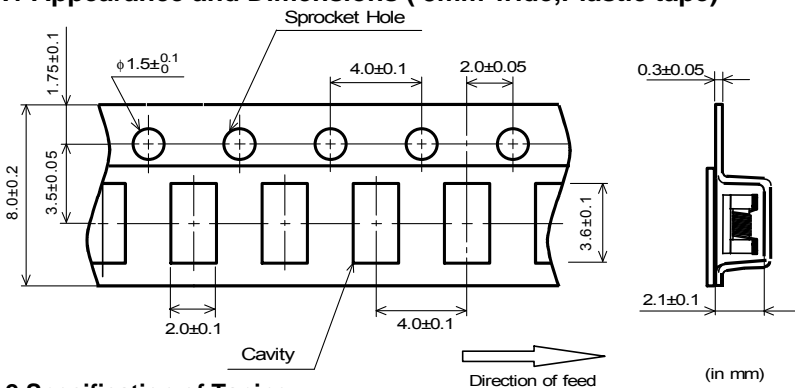

\*Dimension of the Cavity is measured at the bottom side.

14.2 Specification of Taping

- (1)Packing quantity(Standard quantity) 2000 pcs. / reel
- (2)Packing Method  
Products shall be packaged in each embossed cavity of plastic tape and sealed with cover tape.
- (3) Spliced point  
The cover tape have no spliced point.
- (4) Sprocket Hole  
The sprocket holes are to the right as the tape is pulled toward the user.
- (5)Missing components number  
Missing components number within 0.1% of the number per reel or 1 pc., whichever is greater,and are not continuous.The specified quantity per reel is kept.

14.3 Pull Strength of Plastic Tape

|              |          |
|--------------|----------|
| Plastic Tape | 5N min.  |
| Cover Tape   | 10N min. |

14.4 Peeling off force of Cover Tape

0.2 to 0.7N(Minimum value is Typical)  
Speed of Peeling off : 300 mm / min

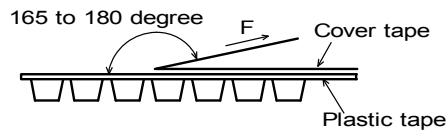

14.5 Dimensions of Leader-tape, Trailer and Reel

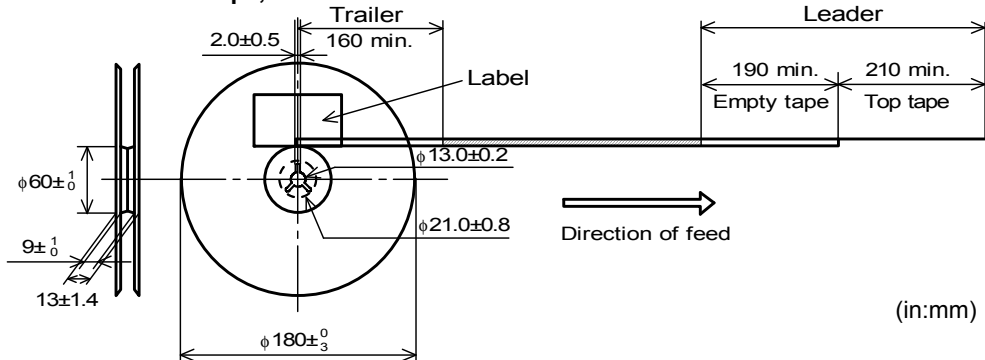

MURATA MFG.CO.,LTD



**16.3 Claening Conditions**

Do not clean after soldering. Some cleaning agents may degrade bonding strength, and characteristics of products by detaching. If cleaning, please contact us.

**16.4 Resin coating**

The impedance value may change due to high cure-stress of resin to be used for coating/molding products. An open circuit issue may occur by mechanical stress caused by the resin, amount/cured shape of resin, or operating condition etc. Some resin contains some impurities or chloride possible to generate chlorine by hydrolysis under some operating condition may cause corrosion of wire of coil, leading to open circuit. So, please pay your careful attention when you select resin in case of coating/molding the products with the resin.

Prior to use the coating resin, please make sure no reliability issue is observed by evaluating products mounted on your board.

**16.5 Attention regarding P.C.B. bending**

The following shall be considered when designing and laying out P.C.B.'s.

- (1) P.C.B. shall be designed so that products are not subject to the mechanical stress due to warping the board.

[Products direction]

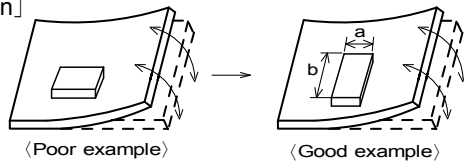

Products shall be location the sideways Direction (Length : a<b) to the mechanical Stress.

- (2) Components location on P.C.B. separation.

It is effective to implement the following measures, to reduce stress in separating the board.

It is best to implement all of the following three measures; however, implement as many measures as possible to reduce stress.

| Contents of Measures   | Stress Level |
|--|--------------|
| (1) Turn the mounting direction of the component parallel to the board separation surface. | A > D *1     |
| (2) Add slits in the board separation part.  | A > B        |
| (3) Keep the mounting position of the component away from the board separation surface.    | A > C        |

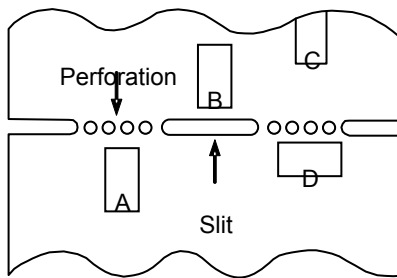

\*1 A > D is valid when stress is added vertically to the perforation as with Hand Separation. If a Cutting Disc is used, stress will be diagonal to the PCB, therefore A > D is invalid.

- (3) Mounting Components Near Screw Holes

When a component is mounted near a screw hole, it may be affected by the board deflection that occurs during the tightening of the screw. Mount the component in a position as far away from the screw holes as possible.

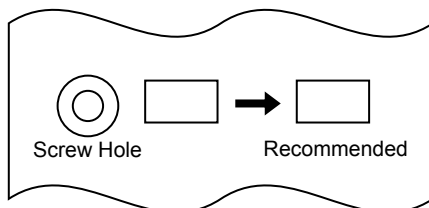

**16.6 Attention Regarding P.C.B. Design**

< The Arrangement of Products >

P.C.B. shall be designed so that products are far from the portion of perforation.

The portion of perforation shall be designed as narrow as possible, and shall be designed so as not to be applied the stress in the case of P.C.B. separation.

Products shall not be arranged on the line of a series of holes when there are big holes in P.C.B. (Because the stress concentrate on the line of holes.)

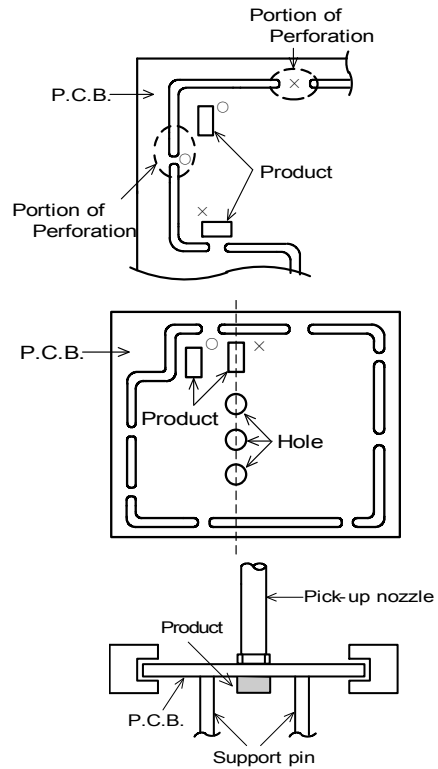

< Products Placing >

Support pins shall be set under P.C.B. to prevent causing a warp to P.C.B. during placing the products on the other side of P.C.B.

< P.C.B. Separation >

P.C.B. shall not be separated with hand. P.C.B. shall be separated with the fixture so as not to cause P.C.B. bending.

**16.7 Standard Land Dimensions (Reflow)**

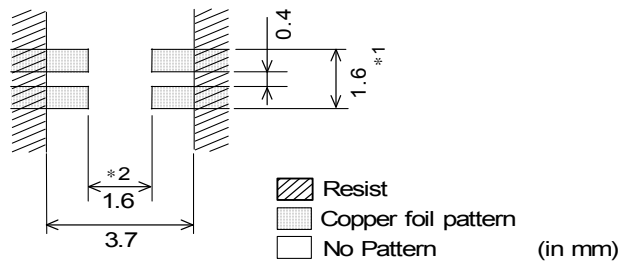

- \*1 If the pattern is made with wider than 1.6mm. It will result to let component turn around, because melting speed is different. In the worst case, short circuit between lines may be occurred.
- \*2 If the pattern is made with wider than 1.6mm, the strength of bending will be reduced.
- \*3 Do not use gilded pattern. A copper wire may cause open by dissolution of metallization.

**16.8 Standard Soldering Condition**

1.Reflow Soldering

(1) Standard printing pattern of solder paste

- Standard thickness of the solder paste should be 100 to 150 μm.
- Use the solder paste printing pattern of the right pattern.
- For the resist and copper foil pattern, use standard land dimensions.
- Use the Solder Sn-3.0Ag-0.5Cu for pattern printing.
- Spread of soldering paste between lines may cause short circuit of lines.

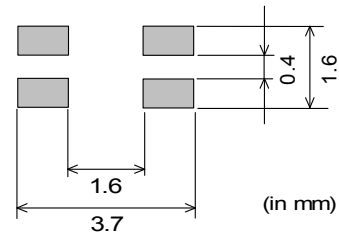

(2) Soldering Temperature

Temperature difference between soldering and surface of components must be within 150°C, in preheating. When components are immersed in liquid after soldering, temperature difference should be within 100°C. If preheating is not enough, components may be cracked and cause deterioration in insulation resistance.

(3) Soldering Condition

Standard soldering profile and the limit soldering profile is as follows.

The excessive limit soldering conditions may cause leaching of the electrode and / or resulting in the deterioration of product quality.

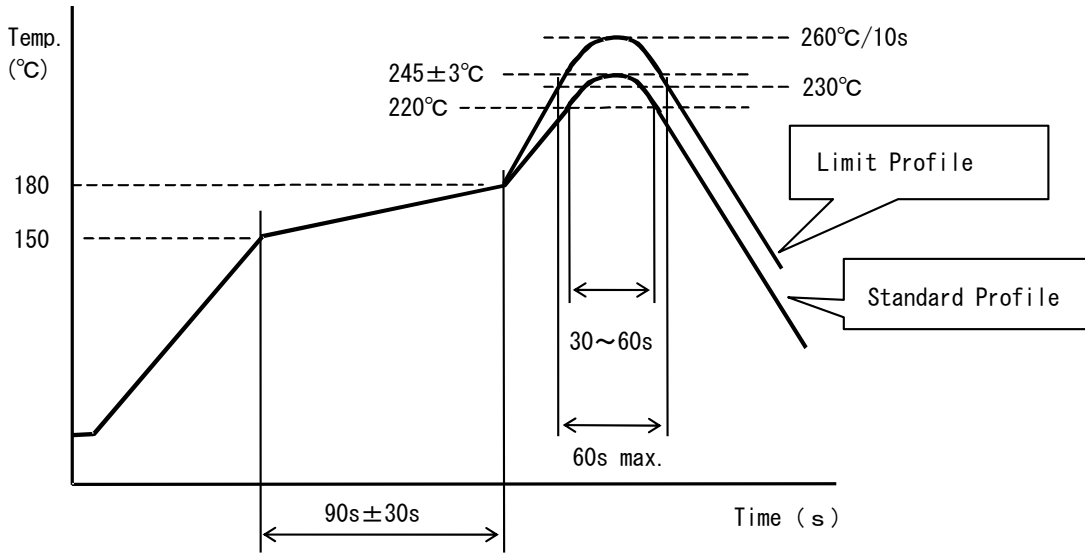

|                  | Standard Profile    | Limit Profile        |
|------------------|---------------------|----------------------|
| Pre-heating      | 150~180°C、90s±30s   |                      |
| Heating          | above 220°C、30s~60s | above 230°C、60s max. |
| Peak temperature | 245±3°C             | 260°C、10s            |
| Cycle of reflow  | 2 times             | 2 times              |

2. Reworking with Soldering iron

The following conditions must be strictly followed when using a soldering iron after being mounted by reflow soldering.

- Pre-heating: 150°C, 1 min
- Tip temperature: 350°C max.
- Soldering time : 3(+1,-0) seconds.
- Soldering iron output: 30W max.
- Tip diameter: φ3mm max.
- Times : 2times max.

Notes : Do not touch the products directly with the soldering iron.

3. Solder Volume

Solder shall be used not to be exceeded the upper limits as shown below.

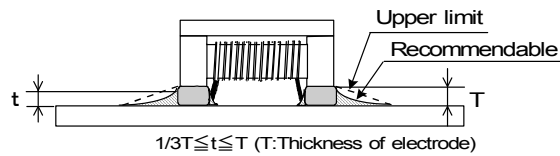

Accordingly increasing the solder volume, the mechanical stress to Chip is also increased. Exceeding solder volume may cause the failure of mechanical or electrical performance.

16.9 Caution for use

- When you hold products with a tweezer, please hold like a figure of the right side, and sharp material, such as a pair of tweezers, shall not be touched to the winding portion to prevent the breaking of wire.
- Mechanical shock should not be applied to the products mounted on the board to prevent the breaking of the core.

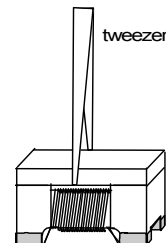



**16.10 Handling of a substrate**

After mounting products on a substrate, do not apply any stress to the product caused by bending or twisting to the substrate when cropping the substrate, inserting and removing a connector from the substrate or tightening screw to the substrate.

Excessive mechanical stress may cause cracking in the product.

Bending

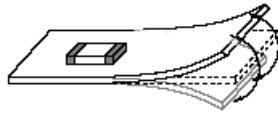

Twisting

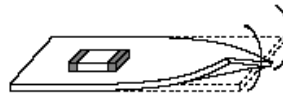
**16.11 Brushing of neighborhood of products**

When you clean the neighborhood of products such as connector pins, bristles of cleaning brush shall not be touched to the winding portion to prevent the breaking of wire.

**16.12 Operating Environment**

Do not use this product under the following environmental conditions, on deterioration of the performance, such as insulation resistance may result from the use.

- (1) in corrosive gases (acidic gases, alkaline gases, chlorine, sulfur gases, organic gases and etc.)
- (2) in the atmosphere where liquid such as organic solvent, may splash on the products.

**16.13 Storage Condition****(1) Storage period**

Use the products within 12 months after delivered.

Solderability should be checked if this period is exceeded.

**(2) Storage environment conditions**

· Products should be stored in the warehouse on the following conditions.

Temperature :  $-10 \sim +40^{\circ}\text{C}$

Humidity : 15 to 85% relative humidity No rapid change on temperature and humidity.

· Products should not be stored in corrosive gases, such as sulfurous, acid gases, alkaline gases, to prevent the following deterioration.

Poor solderability due to the oxidized electrode.

· Products should be stored on the palette for the prevention of the influence from humidity, dust and so on.

· Products should be stored in the warehouse without heat shock, vibration, direct sunlight and so on.

· Products should not be stored under the air tight packaged condition.

**(3) Delivery**

Care should be taken when transporting or handling product to avoid excessive vibration or mechanical shock.

**17.  Note**

- (1) Please make sure that your product has been evaluated in view of your specifications with our product being mounted to your product.
- (2) You are requested not to use our product deviating from the reference specifications.
- (3) The contents of this reference specification are subject to change without advance notice. Please approve our product specifications or transact the approval sheet for product specifications before ordering.

单击下面可查看定价，库存，交付和生命周期等信息

[>>Murata\(村田\)](#)