

CHIP COIL (CHIP INDUCTORS) LQW18AN□□□□00D REFERENCE SPECIFICATION

1.Scope

This reference specification applies to LQW18AN_00 series, Chip coil (Chip Inductors).

2.Part Numbering

(ex)

LQ	W	18	A	N	2N2	D	0	0	D
Product ID	Structure	Dimension (L×W)	Applications and Characteristics	Category	Inductance	Tolerance	Features	Electrode	Packaging D:Taping *B:Bulk

*Bulk packing also available. (A product is put in the plastic bag under the taping conditions.)

3.Rating

- Operating Temperature Range. −55°C to +125°C
- Storage Temperature Range. −55°C to +125°C

Customer Part Number	MURATA Part Number	Inductance		Q (min.)	DC Resistance (Ω max.)	Self Resonant Frequency (MHz min.)	Rated Current (mA)	
		(nH)	Tolerance					
	LQW18AN2N2D00D	2.2	D:±0.5nH	16	0.042	6000	700	
	LQW18AN3N6C00D	3.6	C:±0.2nH D:±0.5nH	25	0.059		750	
	LQW18AN3N6D00D							
	LQW18AN3N9C00D	3.9						
	LQW18AN3N9D00D							
	LQW18AN4N3C00D	4.3						
	LQW18AN4N3D00D							
	LQW18AN4N7D00D	4.7	D:±0.5nH	35	0.082		750	
	LQW18AN5N6C00D	5.6	C:±0.2nH D:±0.5nH					
	LQW18AN5N6D00D							
	LQW18AN6N2C00D	6.2						
	LQW18AN6N2D00D							
	LQW18AN6N8C00D	6.8						
	LQW18AN6N8D00D							
	LQW18AN7N5C00D	7.5	C:±0.2nH D:±0.5nH		35	0.11	650	
	LQW18AN7N5D00D							
	LQW18AN8N2C00D	8.2						
	LQW18AN8N2D00D							
	LQW18AN8N7C00D	8.7						
	LQW18AN8N7D00D							
	LQW18AN9N1C00D	9.1	D:±0.5nH	40	0.13	600		
	LQW18AN9N1D00D							
	LQW18AN9N5D00D	9.5						
	LQW18AN10NG00D	10			G:±2% J:±5%	0.16	5500	550
	LQW18AN10NJ00D							
	LQW18AN11NG00D	11						
	LQW18AN11NJ00D							
	LQW18AN12NG00D	12	40	0.17		4900	500	
	LQW18AN12NJ00D							
	LQW18AN13NG00D	13						
	LQW18AN13NJ00D							
	LQW18AN15NG00D	15						
	LQW18AN15NJ00D							
	LQW18AN16NG00D	16	40	0.16	5500	550		
	LQW18AN16NJ00D							
	LQW18AN18NG00D	18						
	LQW18AN18NJ00D							
	LQW18AN20NG00D	20		40	0.17	4600	500	
	LQW18AN20NJ00D							
	LQW18AN22NG00D	22	40	0.17	4600	500		
	LQW18AN22NJ00D							

Customer Part Number	MURATA Part Number	Inductance		Q (min.)	DC Resistance (Ω max.)	Self Resonant Frequency (MHz min.)	Rated Current (mA)	
		(nH)	Tolerance					
	LQW18AN24NG00D LQW18AN24NJ00D	24	G: \pm 2% J: \pm 5%	40	0.21	3800	500	
	LQW18AN27NG00D LQW18AN27NJ00D	27				3700	440	
	LQW18AN30NG00D LQW18AN30NJ00D	30			0.23	3300	420	
	LQW18AN33NG00D LQW18AN33NJ00D	33				3200		
	LQW18AN36NG00D LQW18AN36NJ00D	36			0.26	2900	400	
	LQW18AN39NG00D LQW18AN39NJ00D	39				2800		
	LQW18AN43NG00D LQW18AN43NJ00D	43			0.29	2700	380	
	LQW18AN47NG00D LQW18AN47NJ00D	47				2600		
	LQW18AN51NG00D LQW18AN51NJ00D	51			38	0.33	2500	370
	LQW18AN56NG00D LQW18AN56NJ00D	56				0.35	2400	360
	LQW18AN62NG00D LQW18AN62NJ00D	62					0.51	2300
	LQW18AN68NG00D LQW18AN68NJ00D	68				0.38	2200	340
	LQW18AN72NG00D LQW18AN72NJ00D	72				0.56	2100	270
	LQW18AN75NG00D LQW18AN75NJ00D	75					2050	
	LQW18AN82NG00D LQW18AN82NJ00D	82		34	0.60	2000	250	
	LQW18AN91NG00D LQW18AN91NJ00D	91			0.64	1900	230	
	LQW18ANR10G00D LQW18ANR10J00D	100			0.68	1800	220	
	LQW18ANR11G00D LQW18ANR11J00D	110		32	1.2	1700	200	
	LQW18ANR12G00D LQW18ANR12J00D	120			1.3	1600	180	
	LQW18ANR13G00D LQW18ANR13J00D	130			1.4	1450	170	
	LQW18ANR15G00D LQW18ANR15J00D	150			1.5	1400	160	
	LQW18ANR16G00D LQW18ANR16J00D	160			2.1	1350	150	
	LQW18ANR18G00D LQW18ANR18J00D	180			25	2.2	1300	140
	LQW18ANR20G00D LQW18ANR20J00D	200		2.4		1250	120	
	LQW18ANR22G00D LQW18ANR22J00D	220				2.5		1200
	LQW18ANR27G00D LQW18ANR27J00D	270		30	3.4	960	110	
	LQW18ANR33G00D LQW18ANR33J00D	330			5.5	800	85	
	LQW18ANR39G00D LQW18ANR39J00D	390					6.2	80
	LQW18ANR47G00D LQW18ANR47J00D	470			7.0	700	75	

4. Testing Conditions

《Unless otherwise specified》

Temperature : Ordinary Temperature / 15°C to 35°C
 Humidity : Ordinary Humidity / 25%(RH) to 85%(RH)

《In case of doubt》

Temperature : 20°C±2°C
 Humidity : 60%(RH) to 70%(RH)
 Atmospheric Pressure : 86kPa to 106 kPa

5. Appearance and Dimensions

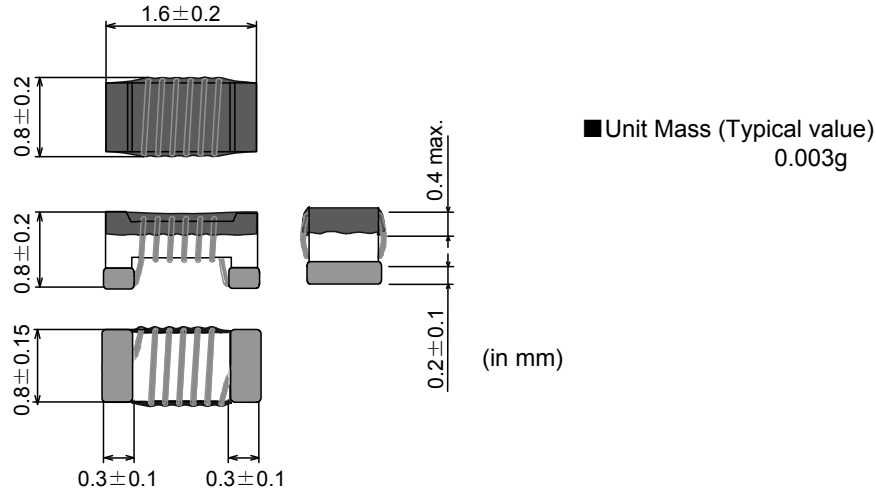

6. Electrical Performance

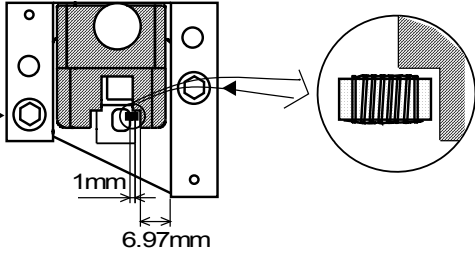
No.	Item	Specification	Test Method
6.1	Inductance	Inductance shall meet item 3.	Measuring Equipment: KEYSIGHT E4991A or equivalent Measuring Frequency: <Inductance> 100MHz <Q> 250MHz/ 2.2nH~39nH 200MHz/ 43nH~68nH 150MHz/ 72nH~160nH 100MHz/ 180nH~470nH Measuring Condition: Test signal level / about 0dBm Electrode spaces / 1.0mm Electrical length / 0.94cm Measuring Fixture: KEYSIGHT 16193A
6.2	Q	Q shall meet item 3.	Position coil under test as shown in below and contact coil with each terminal by adding weight.  Measuring Method: See the endnote. <Electrical Performance: Measuring Method of Inductance/Q>
6.3	DC Resistance	DC Resistance shall meet item 3.	Measuring Equipment: Digital multi meter
6.4	Self Resonant Frequency(S.R.F)	S.R.F shall meet item 3.	Measuring Equipment: KEYSIGHT N5230A or equivalent
6.5	Rated Current	Self temperature rise shall be limited to 20°C max. Inductance Change: within ±10%	The rated current is applied.

7.Mechanical Performance

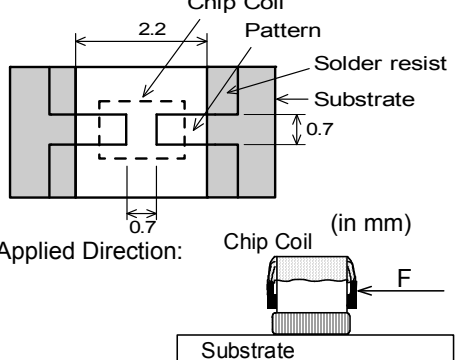
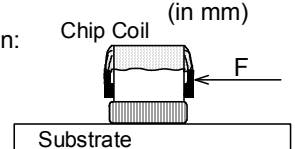
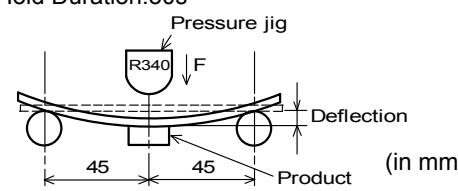
No.	Item	Specification	Test Method
7.1	Shear Test	Chip coil shall not be damaged after tested as test method.	<p>Substrate:Glass-epoxy substrate Chip Coil</p>  <p>Applied Direction: </p> <p>Force:5N Hold Duration:5s±1s</p>
7.2	Bending Test		<p>Substrate:Glass-epoxy substrate (100mm × 40mm × 1.6mm) Speed of Applying Force:1mm / s Deflection:2mm Hold Duration:30s</p>  <p>Deflection (in mm)</p>
7.3	Vibration	Chip coil shall not be damaged after tested as test method.	<p>Oscillation Frequency: 10Hz~55Hz~10Hz for 1 min Total Amplitude:1.5mm Testing Time: A period of 2 hours in each of 3 mutually perpendicular directions.</p>
7.4	Solderability	The wetting area of the electrode shall be at least 90% covered with new solder coating.	<p>Flux:Ethanol solution of rosin,25(wt)% Includes activator equivalent to 0.06(wt)% chlorine.(immersed for 5s to 10s) Solder:Sn-3.0Ag-0.5Cu Pre-Heating:150°C±10°C / 60s to 90s Solder Temperature:240°C±5°C Immersion Time:3s±1s</p>
7.5	Resistance to Soldering Heat	Appearance:No damage Inductance Change: within ±5%	<p>Flux:Ethanol solution of rosin,25(wt)% Includes activator equivalent to 0.06(wt)% Chlorine.(immersed for 5s to 10s) Solder:Sn-3.0Ag-0.5Cu Pre-Heating:150°C±10°C / 60s to 90s Solder Temperature:270°C±5°C Immersion Time:10s±1s Then measured after exposure in the room condition for 24h±2h.</p>

8.Environmental Performance

It shall be soldered on the substrate.

No.	Item	Specification	Test Method
8.1	Heat Resistance	Appearance:No damage Inductance Change: within $\pm 5\%$ Q Change: within $\pm 20\%$	Temperature: $125^{\circ}\text{C} \pm 2^{\circ}\text{C}$ Time: 1000h (+48h, 0h) Then measured after exposure in the room condition for 24h \pm 2h.
8.2	Cold Resistance	Appearance:No damage Inductance Change: within $\pm 5\%$ Q Change: within $\pm 20\%$	Temperature: $-55^{\circ}\text{C} \pm 2^{\circ}\text{C}$ Time: 1000h (+48h, -0h) Then measured after exposure in the room condition for 24h \pm 2h.
8.3	Humidity		Temperature: $40^{\circ}\text{C} \pm 2^{\circ}\text{C}$ Humidity: 90%(RH) to 95%(RH) Time: 1000h (+48h, -0h) Then measured after exposure in the room condition for 24h \pm 2h.
8.4	Temperature Cycle		1 cycle: 1 step: $-55^{\circ}\text{C} \pm 2^{\circ}\text{C}$ / 30min \pm 3 min 2 step: Ordinary temp. / 10min to 15 min 3 step: $+125^{\circ}\text{C} \pm 2^{\circ}\text{C}$ / 30min \pm 3 min 4 step: Ordinary temp. / 10min to 15 min Total of 10 cycles Then measured after exposure in the room condition for 24h \pm 2h.

9.Specification of Packaging

9.1 Appearance and Dimensions of paper tape (8mm-wide)

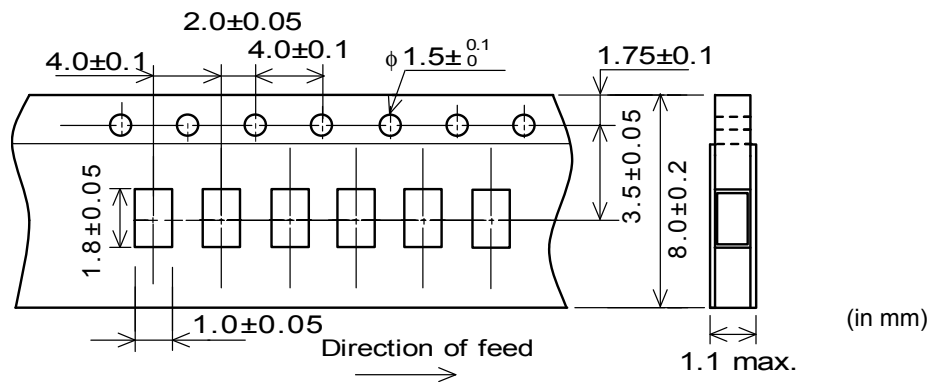

9.2 Specification of Taping

- (1) Packing quantity (standard quantity)
4,000 pcs. / reel
- (2) Packing Method
Products shall be packed in the cavity of the base tape and sealed by top tape and bottom tape.
- (3) Sprocket hole
The sprocket holes are to the right as the tape is pulled toward the user.
- (4) Spliced point
Base tape and Top tape has no spliced point.
- (5) Missing components number
Missing components number within 0.1 % of the number per reel or 1 pc., whichever is greater, and are not continuous. The Specified quantity per reel is kept.

9.3 Pull Strength

Top tape	5N min.
Bottom tape	

9.4 Peeling off force of cover tape

Speed of Peeling off	300mm/min
Peeling off force	0.1N to 0.6N (minimum value is typical)

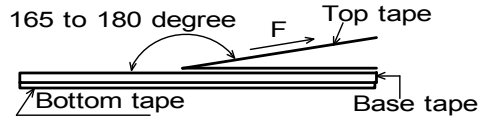

9.5 Dimensions of Leader-tape,Trailer and Reel

There shall be leader-tape (top tape and empty tape) and trailer-tape (empty tape) as follows.

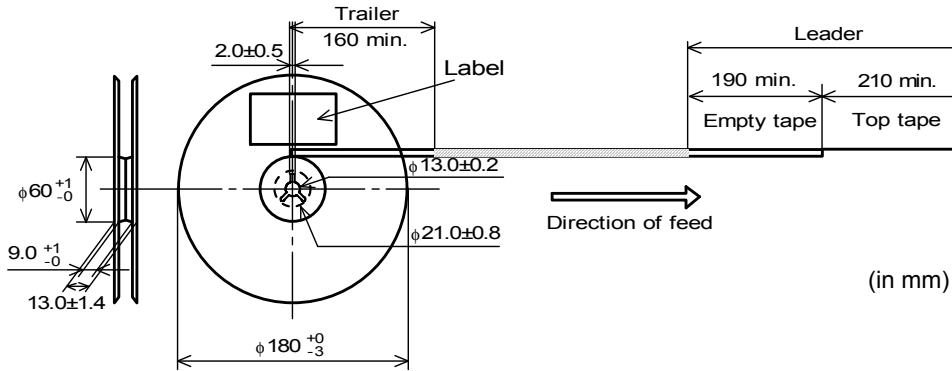

9.6 Marking for reel

Customer part number, MURATA part number, Inspection number(*1) ,RoHS Marking (*2), Quantity etc ...

*1) <Expression of Inspection No.>

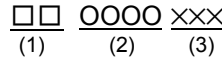

- (1) Factory code
- (2) Date First digit: Year / Last digit of year
Second digit: Month / Jan. to Sep. → 1 to 9, Oct. to Dec. → O, N, D
Third, Fourth digit : Day
- (3) Serial No.

*2) <Expression of RoHS Marking >

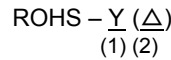

- (1) RoHS regulation conformity parts.
- (2) MURATA classification number

9.7 Marking for Outside package (corrugated paper box)

Customer name, Purchasing order number, Customer part number, MURATA part number, RoHS Marking (*2) ,Quantity, etc ...

9.8. Specification of Outer Case

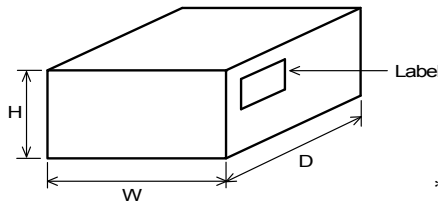

Outer Case Dimensions (mm)			Standard Reel Quantity in Outer Case (Reel)
W	D	H	
186	186	93	5

* Above Outer Case size is typical. It depends on a quantity of an order.

10. ⚠ Caution

Limitation of Applications

Please contact us before using our products for the applications listed below which require especially high reliability for the prevention of defects which might directly cause damage to the third party's life, body or property.

- (1) Aircraft equipment
- (2) Aerospace equipment
- (3) Undersea equipment
- (4) Power plant control equipment
- (5) Medical equipment
- (6) Transportation equipment (vehicles, trains, ships, etc.)
- (7) Traffic signal equipment
- (8) Disaster prevention / crime prevention equipment
- (9) Data-processing equipment
- (10) Applications of similar complexity and /or reliability requirements to the applications listed in the above

11. Notice

Products can only be soldered with reflow.
 This product is designed for solder mounting.
 Please consult us in advance for applying other mounting method such as conductive adhesive.

11.1 Land pattern designing

Recommended land patterns for reflow soldering are as follows:
 These have been designed for Electric characteristics and solderability.
 Please follow the recommended patterns. Otherwise, their performance which includes electrical performance or solderability may be affected, or result to "position shift" in soldering process.

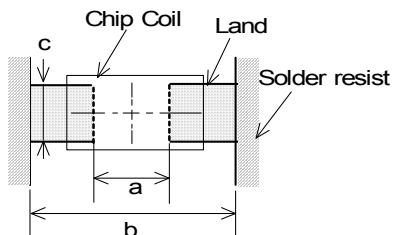

A	0.6 to 0.8
B	1.9 to 2.0
C	0.7 to 1.0

(in mm)

11.2 Flux, Solder

- Use rosin-based flux.
 Includes middle activator equivalent to 0.06(wt)% to 0.1(wt)% Chlorine.
 Don't use highly acidic flux with halide content exceeding 0.2(wt)% (chlorine conversion value).
 Don't use water-soluble flux.
- Use Sn-3.0Ag-0.5Cu solder.
- Standard thickness of solder paste : 100 μm to 150 μm.

11.3 Reflow soldering conditions

- Pre-heating should be in such a way that the temperature difference between solder and product surface is limited to 150°C max. Cooling into solvent after soldering also should be in such a way that the temperature difference is limited to 100°C max.
 Insufficient pre-heating may cause cracks on the product, resulting in the deterioration of products quality.
- Standard soldering profile and the limit soldering profile is as follows.
 The excessive limit soldering conditions may cause leaching of the electrode and / or resulting in the deterioration of product quality.
- Reflow soldering profile

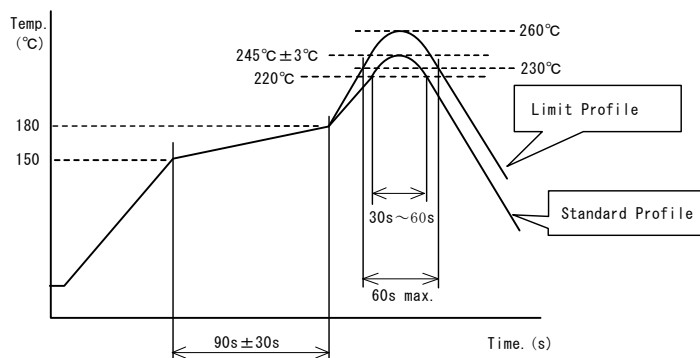

	Standard Profile	Limit Profile
Pre-heating	150°C~180°C , 90s±30s	
Heating	above 220°C, 30s~60s	above 230°C, 60s max.
Peak temperature	245°C±3°C	260°C, 10s
Cycle of reflow	2 times	

11.4 Reworking with soldering iron

The following conditions must be strictly followed when using a soldering iron.

Pre-heating	150°C, 1 min
Tip temperature	350°C max.
Soldering iron output	80W max.
Tip diameter	φ 3mm max.
Soldering time	3(+1,-0)s
Time	2 times

Note :Do not directly touch the products with the tip of the soldering iron in order to prevent the crack on the products due to the thermal shock.

11.5 Solder Volume

- Solder shall be used not to be exceeded the upper limits as shown below.
- Accordingly increasing the solder volume, the mechanical stress to Chip is also increased. Exceeding solder volume may cause the failure of mechanical or electrical performance.

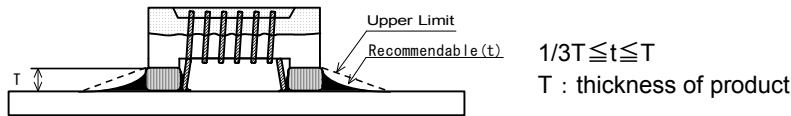

11.6 Product's location

The following shall be considered when designing and laying out P.C.B.'s.

- (1) P.C.B. shall be designed so that products are not subject to the mechanical stress due to warping the board.

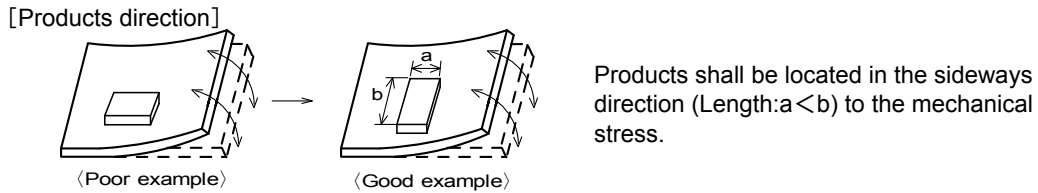

- (2) Components location on P.C.B. separation.

It is effective to implement the following measures, to reduce stress in separating the board.

It is best to implement all of the following three measures; however, implement as many measures as possible to reduce stress.

Contents of Measures	Stress Level
(1) Turn the mounting direction of the component parallel to the board separation surface.	A > D *1
(2) Add slits in the board separation part.	A > B
(3) Keep the mounting position of the component away from the board separation surface.	A > C

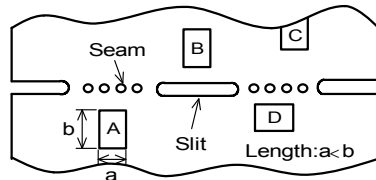

*1 A > D is valid when stress is added vertically to the perforation as with Hand Separation. If a Cutting Disc is used, stress will be diagonal to the PCB, therefore A > D is invalid.

(3) Mounting Components Near Screw Holes

When a component is mounted near a screw hole, it may be affected by the board deflection that occurs during the tightening of the screw. Mount the component in a position as far away from the screw holes as possible.

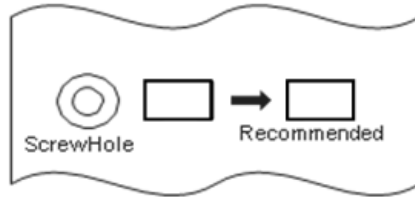
**11.7 Cleaning Conditions**

Products shall be cleaned on the following conditions.

- (1) Cleaning temperature shall be limited to 60°C max.(40°C max for IPA)
- (2) Ultrasonic cleaning shall comply with the following conditions with avoiding the resonance phenomenon at the mounted products and P.C.B.
Power : 20 W / l max. Frequency : 28kHz to 40kHz Time : 5 min max.
- (3) Cleaner
 1. Alcohol type cleaner
Isopropyl alcohol (IPA)
 2. Aqueous agent
PINE ALPHA ST-100S
- (4) There shall be no residual flux and residual cleaner after cleaning.
In the case of using aqueous agent, products shall be dried completely after rinse with de-ionized water in order to remove the cleaner.
- (5) Other cleaning Please contact us.

11.8 Resin coating

The inductance value may change due to high cure-stress of resin to be used for coating/molding products. An open circuit issue may occur by mechanical stress caused by the resin, amount/cured shape of resin, or operating condition etc. Some resin contains some impurities or chloride possible to generate chlorine by hydrolysis under some operating condition may cause corrosion of wire of coil, leading to open circuit. So, please pay your careful attention in when you select resin in case of coating/molding the products with the resin.

Prior to use the coating resin, please make sure no reliability issue is observed by evaluating products mounted on your board.

11.9 Caution for use

- Sharp material such as a pair of tweezers or other material such as bristles of cleaning brush , shall not be touched to the winding portion to prevent the breaking of wire.
- Mechanical shock should not be applied to the products mounted on the board to prevent the breaking of the core.

11.10 Notice of product handling at mounting

In some mounting machines,when picking up components support pin pushes up the components from the bottom of base tape. In this case, please remove the support pin. The support pin may damage the components and break wire.

In rare case ,the laser recognition can not recognize this component. Please contact us when you use laser recognition. (There is no problem with the permeation and reflection type.)

11.11 Handling of a substrate

After mounting products on a substrate, do not apply any stress to the product caused by bending or twisting to the substrate when cropping the substrate, inserting and removing a connector from the substrate or tightening screw to the substrate.

Excessive mechanical stress may cause cracking in the product.

Bending

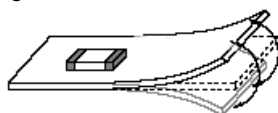

Twisting

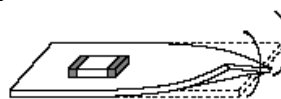

11.12 Storage and Handling Requirements**(1) Storage period**

Use the products within 12 months after delivered.
Solderability should be checked if this period is exceeded.

(2) Storage conditions

- Products should be stored in the warehouse on the following conditions.
 - Temperature : -10°C to 40°C
 - Humidity : 15% to 85% relative humidity No rapid change on temperature and humidity
- Don't keep products in corrosive gases such as sulfur, chlorine gas or acid, or it may cause oxidization of electrode, resulting in poor solderability.
- Products should not be stored on bulk packaging condition to prevent the chipping of the core and the breaking of winding wire caused by the collision between the products.
- Products should be stored on the palette for the prevention of the influence from humidity, dust and so on.
- Products should be stored in the warehouse without heat shock, vibration, direct sunlight and so on.

(3) Handling Condition

Care should be taken when transporting or handling product to avoid excessive vibration or mechanical shock.

12.  Note

- (1) Please make sure that your product has been evaluated in view of your specifications with our product being mounted to your product.
- (2) You are requested not to use our product deviating from the reference specifications.
- (3) The contents of this reference specification are subject to change without advance notice.
Please approve our product specifications or transact the approval sheet for product specifications before ordering.

<Electrical Performance:Measuring Method of Inductance/Q>

(1) Residual elements and stray elements of test fixture can be described by F-parameter shown in following.

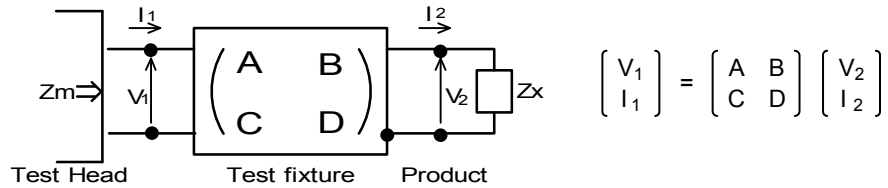

(2) The impedance of chip coil Z_x and measured value Z_m can be described by input/output current/voltage.

$$Z_m = \frac{V_1}{I_1}, \quad Z_x = \frac{V_2}{I_2}$$

(3) Thus, the relation between Z_x and Z_m is following;

$$Z_x = \alpha \frac{Z_m - \beta}{1 - Z_m \Gamma} \quad \text{where, } \alpha = D / A = 1$$

$$\beta = B / D = Z_{sm} - (1 - Y_{om}) Z_{ss}$$

$$\Gamma = C / A = Y_{om}$$

$$\left(\begin{array}{l} Z_{sm} : \text{measured impedance of short chip} \\ Z_{ss} : \text{residual impedance of short chip (0.771nH)} \\ Y_{om} : \text{measured admittance when opening the fixture} \end{array} \right)$$

(4) L_x and Q_x shall be calculated with the following equation.

$$L_x = \frac{\text{Im}(Z_x)}{2\pi f}, \quad Q_x = \frac{\text{Im}(Z_x)}{\text{Re}(Z_x)}$$

L_x : Inductance of chip coil
 Q_x : Q of chip coil
 f : Measuring frequency

单击下面可查看定价，库存，交付和生命周期等信息

[>>Murata\(村田\)](#)

[>>点击查看相关商品](#)