

SF2164E

**1484.3 MHz
SAW Filter**

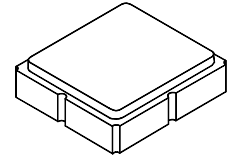

SM3030-8

- SAW Filter for Digital Television
- Complies with Directive 2002/95/EC (RoHS)



Characteristics:

Differential Source and Load Configuration

Terminating Source/Load Impedance : $Z_S = 150 \Omega$

Maximum Rating

Rating	Value	Units
Input Power Level	+10	dBm
DC Voltage on any Non-ground Terminal	3	V
Operating Temperature Range	-40 to +85	°C
Storage Temperature Range	-50 to +95	°C
Suitable for Lead-free Soldering - Maximum Soldering Profile	260 °C for 30 s	

Electrical Characteristics

Characteristic	Sym	Notes	Min	Typ	Max	Units
Center Frequency	f_C			1484.3		MHz
Insertion Loss, 1464.3 to 1504.3 MHz	IL			2.0	4.5	dB
Amplitude Ripple, 1464.3 to 1504.3 MHz		1		0.6	2.0	dB
Phase Error, 1464.3 to 1504.3 MHz		1		3.2	6.0	deg
Input/Output VSWR, 1464.3 to 1504.3 MHz				2:1	2.5:1	
2 dB Bandwidth			40	60		MHz
Attenuation Referenced to 0 dB:						
50 to 1402.3 MHz			48	60		dB
1566.3 to 1810.5 MHz			50	60		
1810.5 to 4250 MHz			55	65		
4250 to 6000 MHz			30	38		

Case Style	SM3030-8 3.0 x 3.0 mm Nominal Footprint					
Lid Symbolization, Y=year, WW=week, S=shift, dot=pin 1 indicator	860, YWWS					
Standard Reel Quantity	Reel Size 7 Inch					500 Pieces/Reel
	Reel Size 13 Inch					3000 Pieces/Reel

Electrical Connections

	Connection	Terminals
Port 1	Balanced Input	1,2
Port 2	Balanced Output	5,6
	Ground	All Others

Dot Indicates Pin 1



CAUTION: Electrostatic Sensitive Device. Observe precautions for handling.

NOTES:

1. Specification applies to any 30 MHz segment within the passband.
2. US and international patents may apply.
3. Murata, stylized Murata logo, and Murata N.A., Inc. are registered trademarks of Murata Manufacturing Co., Ltd.

Passband Amplitude and SWR Response

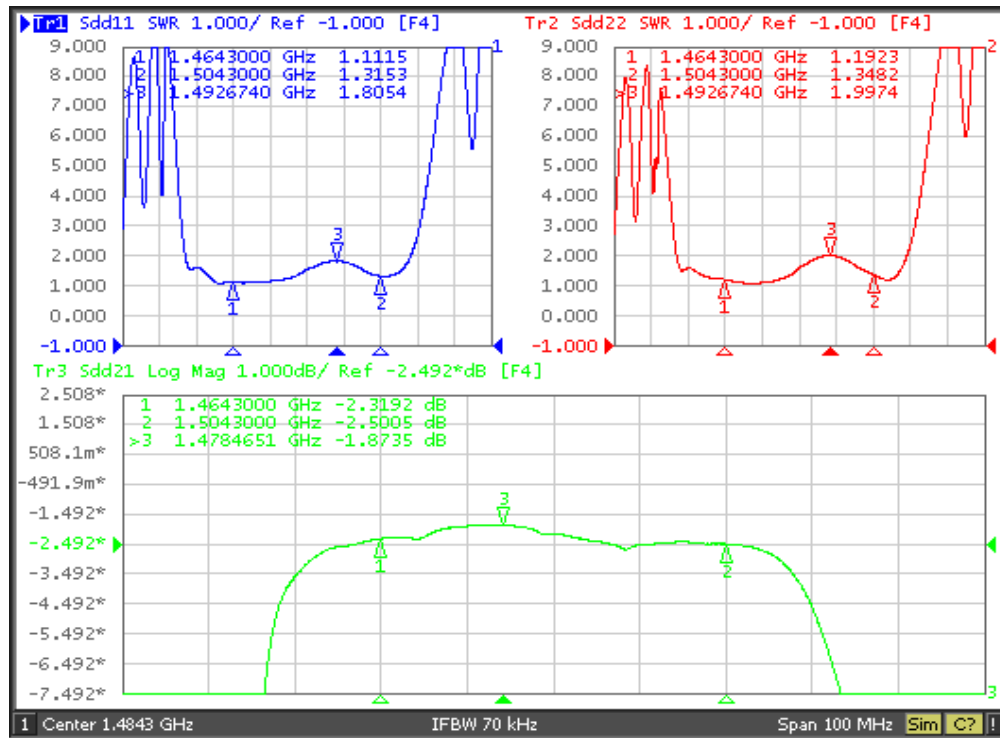

Broadband Response

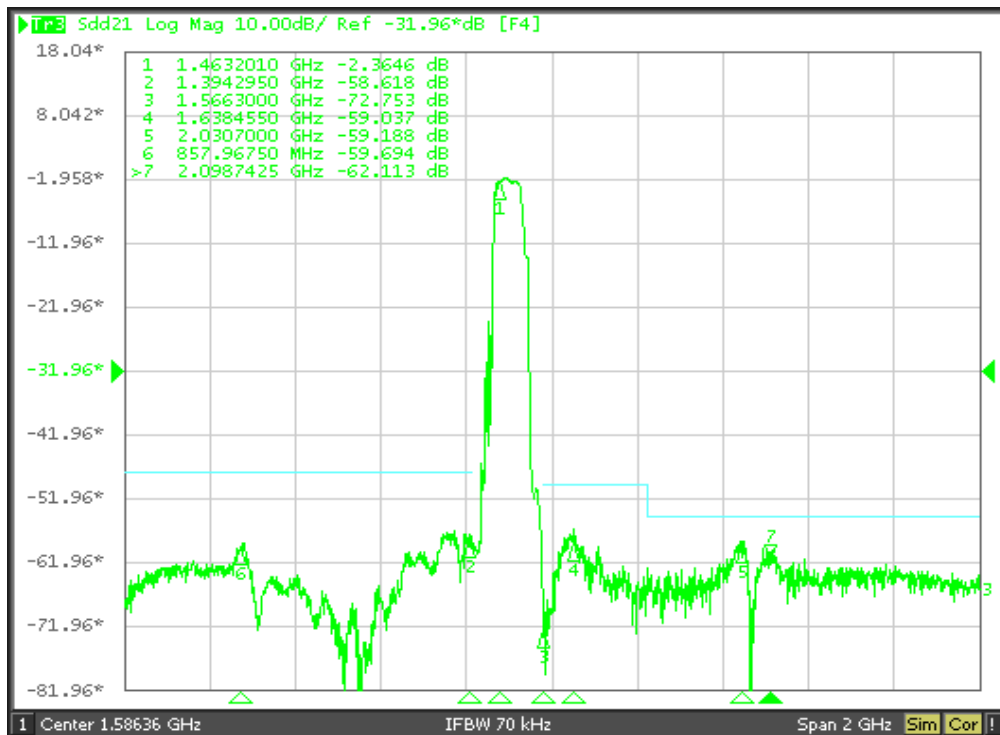

S₁₁, S₂₂ and S₂₁ Plots

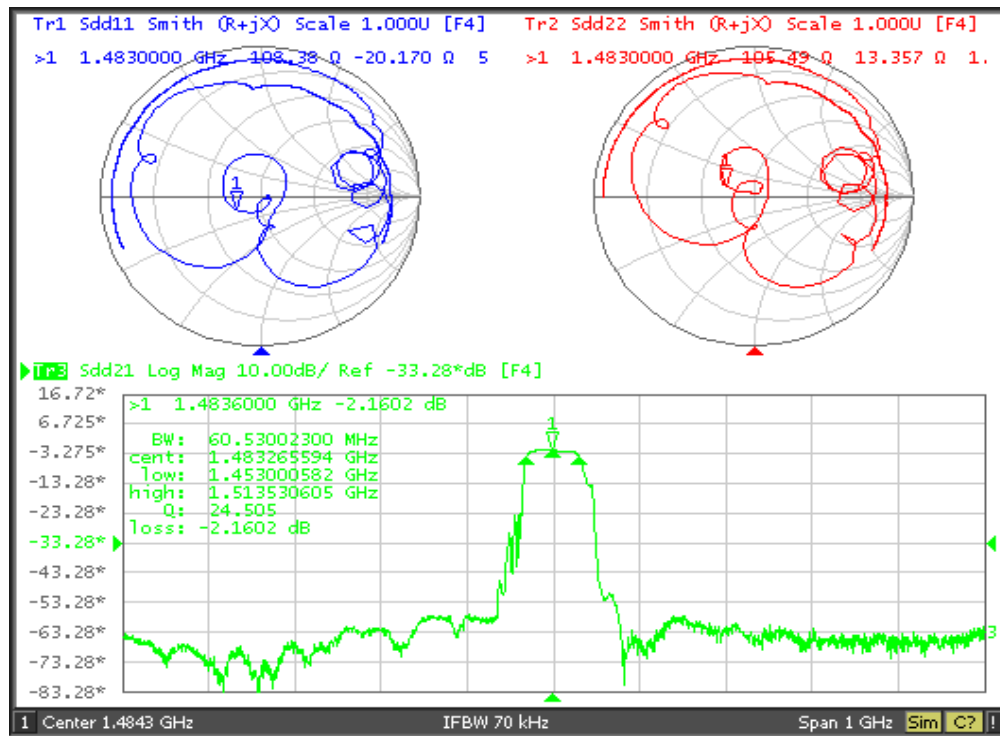

Test Circuit, Bottom View

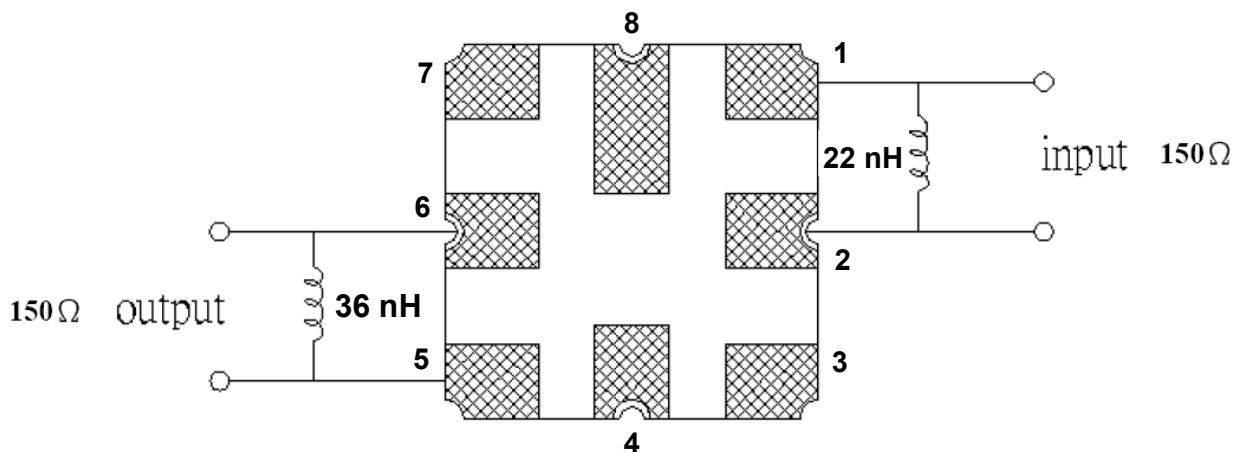

8-Terminal Ceramic Surface-Mount Case 3.0 X 3.0 mm Nominal Footprint

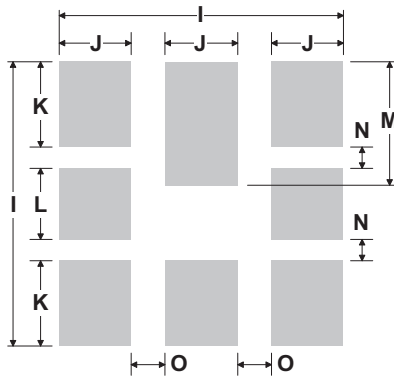
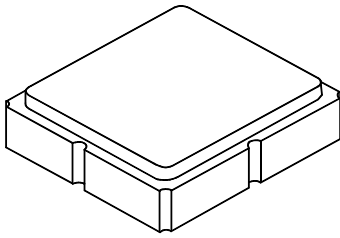

PCB Footprint Top View

Case and PCB Footprint Dimensions

Dimension	mm			Inches		
	Min	Nom	Max	Min	Nom	Max
A	2.87	3.0	3.13	0.113	0.118	0.123
B	2.87	3.0	3.13	0.113	0.118	0.123
C	1.14	1.27	1.40	0.045	0.050	0.055
D	0.79	0.92	1.05	0.031	0.036	0.041
E	0.62	0.75	0.88	0.024	0.029	0.034
F	0.47	0.60	0.73	0.018	0.024	0.029
G	0.47	0.60	0.73	0.018	0.024	0.029
H	1.07	1.20	1.33	0.042	0.047	0.052
I		3.19			0.126	
J		0.81			0.032	
K		0.96			0.038	
L		0.81			0.032	
M		1.39			0.055	
N		0.23			0.009	
O		0.38			0.015	

Case Materials

Materials	
Solder Pad Plating	0.3 to 1.0 μm Gold over 1.27 to 8.89 μm Nickel
Lid Plating	2.0 to 3.0 μm Nickel
Body	Al_2O_3 Ceramic
Pb Free	

TOP VIEW

BOTTOM VIEW

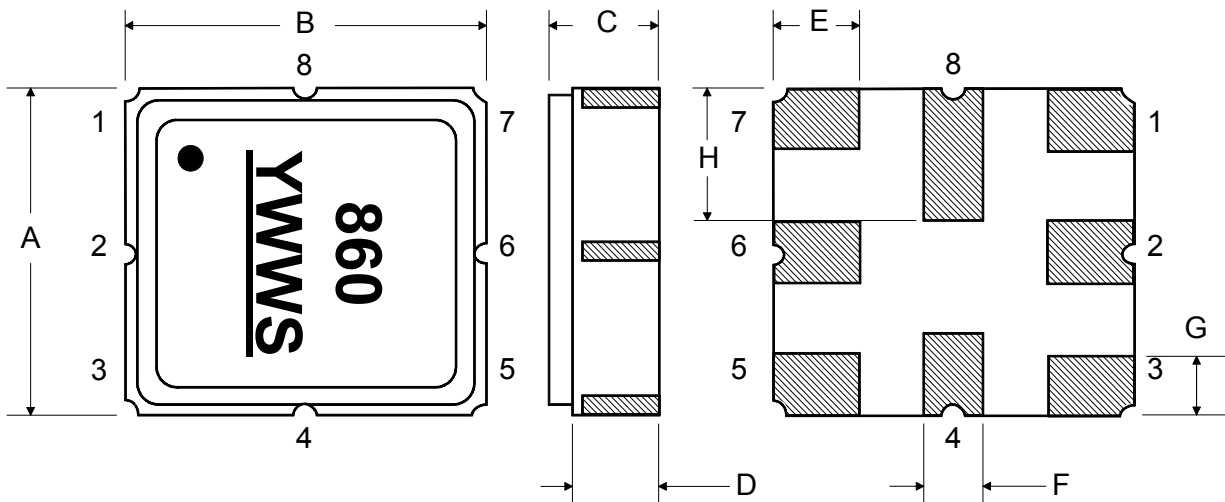

Tape and Reel Specifications

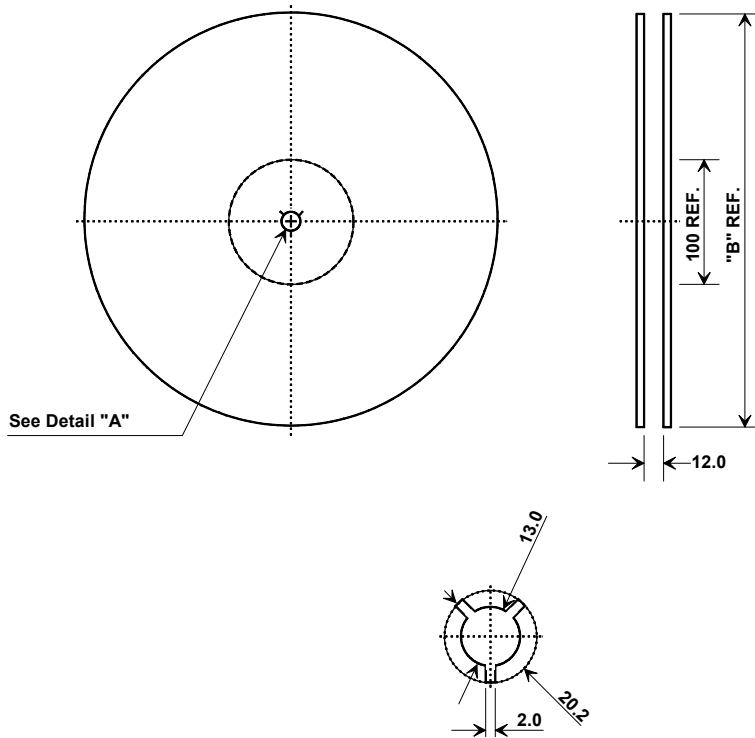

"B"		Quantity Per Reel
Inches	millimeters	
7	178	500
13	330	3000

COMPONENT ORIENTATION and DIMENSIONS

Carrier Tape Dimensions	
Ao	3.35 mm
Bo	3.35 mm
Ko	1.4 mm
Pitch	8.0 mm
W	12.0 mm

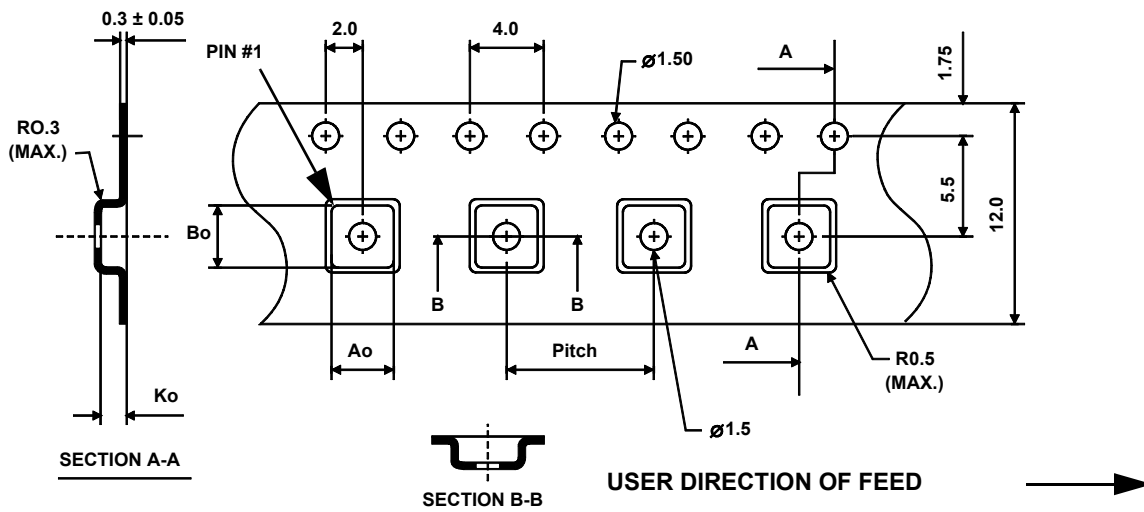

单击下面可查看定价，库存，交付和生命周期等信息

[>>Murata\(村田\)](#)