



PRODUCT OVERVIEW

DMS01-CL-RS12-C is a robust digital panel meter that provides precise measurement and display of current loop process signals on a highly visible red 1" (25mm) tall, 4 1/2 digit seven-segment LED display with adjustable brightness. It provides selectable 4-20 mA or 0-20 mA current range, up to 32 display ranges and choice of user calibration or factory calibration modes. An external 12VDC power source provides power to the meter. An internal DC-DC converter accommodates a +/-48V common-mode measurement range with respect to the power supply input, simplifying a wide range of measurement applications and an internal digital filter enhances performance in electrically noisy environments making this digital panel meter ideal for laboratory instrumentation, factory automation, and any application requiring precision measurement.

Features

- Measures 4-20mA or 0-20mA current loop process signals
- 32 user-selectable span (display) ranges
- Bright 1" red LED display, readable at distance of 80 feet (~24 m)
- Adjustable display brightness
- Wide common-mode input range ($\pm 48V$)
- Digital filter for optimizing measurements in electrically noisy environments
- Operates from an external 12VDC power supply
- Mounts with adhesive strips (supplied) or screws
- 0.1% typical accuracy
- Two-year warranty

ORDERING INFORMATION:

DMS01-CL-RS12-C	Digital Current Loop Process Meter, 1" Red Display, 12VDC Power
-----------------	---

SIMPLIFIED BLOCK DIAGRAM

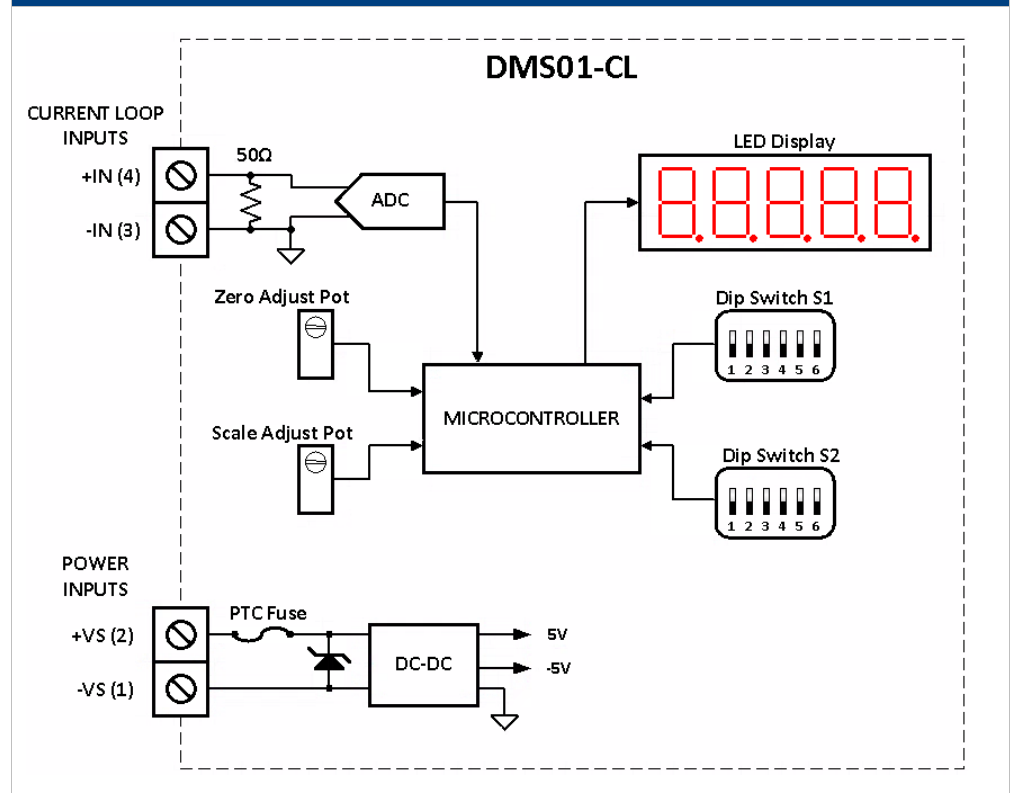

For full details go to
www.murata-ps.com/rohs

DC ELECTRICAL CHARACTERISTICS (Typical @ 25C, +12VDC supply unless otherwise noted)

Parameter	Min	Typ	Max	Units
Supply Voltage (Operating)	11	12	13	V
Absolute Maximum Supply Voltage	-1		+14	V
Supply Current ¹ (Operating at maximum intensity)			100	mA
(Operating at minimum intensity)			60	mA
Digits (Displayed)	3.5 – 4.5, depending on display range			
Digit Height	1 (25.4)			inch (mm)
Display Update Rate	3.5			Sa/s
Decimal Selection	Manual, (fixed at 00.00 when displaying physical input current)			
Display Color	Red (627nm pk)			
Over-range indication	Flashing Display			
Measurement range (0-20mA range)	0		20	mA
Display Span Range (unipolar mode)	2000 to 20,000, 32 codes			
(bipolar mode)	-9500 to +9500			
Accuracy		0.1%	1%	
Zero-Offset (0-20mA range)	-2		+2	count
Input Impedance		50		Ω
Offset Trim Range	±5% of span range, see span range selection table			
Gain Trim Range	variable, see span range selection table			
Temperature Drift (0 to +50°C)		0.8		count/°C
Absolute Maximum Input Current (-IIN to +IIN)	-40		+40	mA
Common-Mode Input Range (-VIN to -VS)	-48		+48	V

¹ based on a display value of "1.888"

PHYSICAL/ENVIRONMENTAL

Parameter	Min	Typ	Max	Units
Operating Temperature	0		+50	°C
Storage Temperature	-40		+75	°C
Humidity (Non-condensing)			85	%RH
Weight		6.14 (174)		oz (g)

User Controls

Brightness	single-turn potentiometer			
Offset and Gain Adjustment	QTY 2 12-turn trim potentiometers			
Dipswitch configuration setting for:				
- Input current range				
- Digital filter enable				
- Span (display) range				
- Unipolar / Bipolar mode				
- Trim enable				
Overall Dimensions	5.86 (149) L x 3.36 (86) W x 1.43 (37) H			inch (mm)

Terminal Blocks

Parameter	Min	Typ	Max	Units
Wire Size	24		14	AWG
Insulation Strip Length		0.25 (6)		inch (mm)
Screw Tightening torque		56.6 (0.4)		oz-in (N-m)

MEASUREMENT TYPE AND CAPABILITIES:

- Measures 4-20 or 0-20 mA DC current loop process signals with 32 user-selectable span ranges (via S1, S2), displaying 3-1/2 to 4 1/2 digits of resolution.
- Two user-selectable modes of operation: unipolar (supporting only positive readings) or bipolar (supports negative output readings).
- The meter's measurement terminals are electrically isolated from the power terminals through a DC-DC converter, providing a high common-mode input range (+/-48V) for the input (relative to the power terminals), simplifying a wide range of measurement applications.
- Meter requires an external 12VDC power supply (not included).

REAR PANEL LAYOUT: SCREW TERMINAL CONNECTIONS & CONTROLS

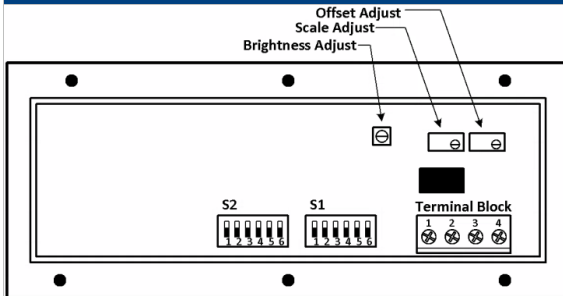

Terminal Block		
Terminal #	Name	Function
1	-VS	Power Supply Terminals (+12VDC)
2	+VS	
3	-IN	Measurement Input Terminals
4	+IN	

Brightness Adjust – This single-turn potentiometer supports adjustment of the meter's LED display brightness for maximum readability. Turning the pot clockwise increases brightness, while turning it counterclockwise decreases brightness.

Offset Adjust – This 12-turn potentiometer supports the offset adjustments of the span ranges. See the span range selection table for the maximum allowed offset for each span range. Turning the pot clockwise will give a negative offset, while turning it counterclockwise gives a positive offset.

Gain Scale Adjust – This 12-turn potentiometer supports gain adjustments of the span ranges. This allows the user to select values between each of the span ranges, between 1780 to 20300 (unipolar mode) and -9785 to 9785 (bipolar mode). See the span range selection table for the maximum allowed gain for each span range. Turning the pot clockwise decreases (-) the gain, while turning it counterclockwise increases (+) the gain (see Span Ranges below).

S1 & S2 – 6-position dipswitches provided for configuration the meter's various options. See [Meter Configuration](#) below for details.

CONNECTION EXAMPLES:

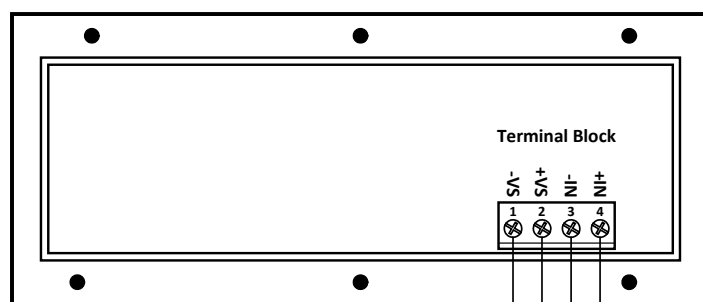

Note: The voltage between point A and point B must be within +/- 48V

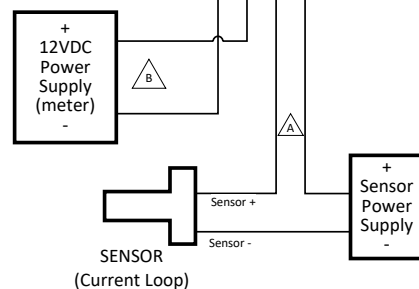

This example illustrates an application where the Current sensor is connected to terminals 3 and 4, where terminal 3 is the negative input terminal (-IN) and terminal 4 is the positive input terminal (+IN).

The 12V power supply (not included) connects to terminals 1 and 2, where terminal 1 is the negative power supply terminal (-VS) and terminal 2 is the positive power supply terminal (+VS) and the sensor is powered from a separate external power supply. Note: it is possible to power both the sensor and the meter from the same power supply provided the sensor can operate from +12VDC.

METER CONFIGURATION

This Meter is configured through two 6 position dipswitches S1 and S2 on the back of the meter. Each switch position is identified by SW#. For example, SW1 is switch 1 on S1, and controls the input range, while SW1 on S2 selects one of the span ranges. The following illustrate the possible configurations:

Input Range Selection

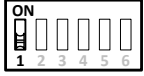
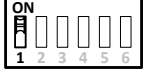
Input Range	SW1	Dipswitch S1	Description
4-20mA	OFF		SW1 on S1 controls the meter's input range. In the OFF position the input range is 4-20 mA, while in the ON position the meter's range is 0-20 mA.
0-20mA	ON		

Digital Filter On/Off Selection

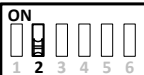
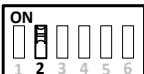



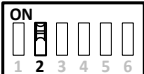





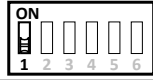
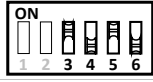
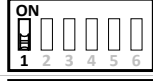

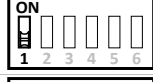
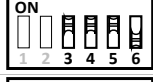
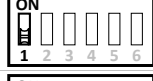

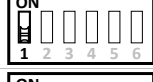

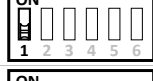

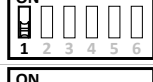
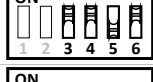
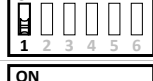
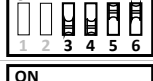
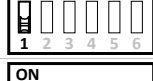







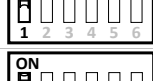

Digital Filter	SW2	Dipswitch S1	Description
OFF	OFF		SW2 on S1 controls the meter's digital filter. In the OFF position, the filter is disabled and readings are updated at maximum speed. In the ON position, the filter is enabled, and readings are processed through a moving average filter, which results in more stable readings, but a slower response.
ON	ON		

Unipolar/Bipolar Mode Selection

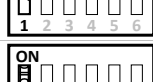
Mode	SW2	Dipswitch S2	Description
Unipolar	OFF		Bipolar mode allows the user to display negative values. For example, if the meter is set to 0-20 mA input, span of 6000 and set in unipolar mode, then 0 mA input results in a count of 0 on the display, while 20 mA input results in a count of 6000 on the display. If the meter is set to bipolar mode with the same settings, 0 mA input results in a count of -6000 on the display, while 20 mA results in a count of +6000 on the display. SW2 on S2 controls whether the meter is in unipolar or bipolar mode. Unipolar mode can display values between 0 to +20000 depending on the span range setting. Bipolar mode can display values between -9500 to +9500 depending on the span range setting. The bipolar range is not offered beyond ± 9500 because of display limitations.
Bipolar	ON		

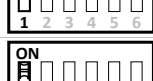
Span Range Selection

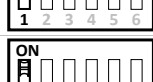

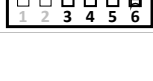
Span Range	Gain Adjustment	Offset Adjustment	S2		S1			Dipswitch S2	Dipswitch S1
			SW1	SW3	SW4	SW5	SW6		
Input Current (mA)	N/A	N/A	OFF	OFF	OFF	OFF	OFF		
2000	220 \pm 2	100 \pm 2	OFF	ON	OFF	OFF	OFF		
2500	288 \pm 2	125 \pm 1	OFF	OFF	ON	OFF	OFF		
3000	255 \pm 2	150 \pm 2	OFF	ON	ON	OFF	OFF		
3500	263 \pm 2	175 \pm 2	OFF	OFF	OFF	ON	OFF		

Span Range Selection continued									
Span Range	Gain Adjustment	Offset Adjustment	S2		S1			Dipswitch S2	Dipswitch S1
			SW1	SW3	SW4	SW5	SW6		
4000	260 ±2	200 ±2	OFF	ON	OFF	ON	OFF		
4500	270 ±2	225 ±2	OFF	OFF	ON	ON	OFF		
5000	250 ±2	250 ±2	OFF	ON	ON	ON	OFF		
5500	275 ±2	275 ±2	OFF	OFF	OFF	OFF	ON		
6000	270 ±2	300 ±2	OFF	ON	OFF	OFF	ON		
6500	260 ±2	325 ±2	OFF	OFF	ON	OFF	ON		
7000	280 ±2	350 ±2	OFF	ON	ON	OFF	ON		
7500	263 ±2	375 ±2	OFF	OFF	OFF	ON	ON		
8000	280 ±2	400 ±2	OFF	ON	OFF	ON	ON		
8500	298 ±2	425 ±2	OFF	OFF	ON	ON	ON		
9000	270 ±2	450 ±2	OFF	ON	ON	ON	ON		
9500	285 ±2	475 ±2	ON	OFF	OFF	OFF	OFF		
10000	250 ±2	500 ±2	ON	ON	OFF	OFF	OFF		
10500	263 ±2	525 ±2	ON	OFF	ON	OFF	OFF		
11000	275 ±2	550 ±2	ON	ON	ON	OFF	OFF		
11500	288 ±2	575 ±2	ON	OFF	OFF	ON	OFF		
12000	300 ±2	600 ±2	ON	ON	OFF	ON	OFF		
12500	250 ±2	625 ±2	ON	OFF	ON	ON	OFF		
13000	260 ±2	650 ±2	ON	ON	ON	ON	OFF		

Span Range Selection continued

Span Range	Gain Adjustment	Offset Adjustment	S2		S1			Dipswitch S2	Dipswitch S1
			SW1	SW3	SW4	SW5	SW6		
13500	270 ±2	675 ±2	ON	OFF	OFF	OFF	ON		
14000	280 ±2	700 ±2	ON	ON	OFF	OFF	ON		
15000	750 ±2	750 ±2	ON	OFF	ON	OFF	ON		
16000	320 ±2	800 ±2	ON	ON	ON	OFF	ON		
17000	765 ±2	850 ±2	ON	OFF	OFF	ON	ON		
18000	270 ±2	900 ±2	ON	ON	OFF	ON	ON		
19000	760 ±2	950 ±2	ON	OFF	ON	ON	ON		
20000	300 ±2	1000 ±2	ON	ON	ON	ON	ON		

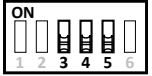
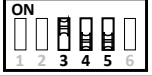
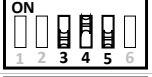
Decimal Point Selection

Decimal Placement	SW3	SW4	SW5	Dipswitch S2
0000	OFF	OFF	OFF	
0.000	ON	OFF	OFF	
00.00	OFF	ON	OFF	
000.0	OFF	OFF	ON	

When measuring the physical current the decimal placement is fixed at 00.00. When any of the span range switches are turned ON the decimal point placement has to be manually selected. SW3 through SW5 on S2 control the decimal point placement options as shown in the table.

Trim Enable Selection

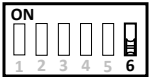
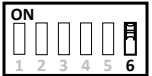
Trim Enable	SW6	Dipswitch S2
OFF	OFF	
ON	ON	

QTY 2 potentiometers for adjusting gain and offset are enabled by SW6 on S2. In the "OFF" position, the trim is disabled and the meter runs from factory calibrated span ranges. In the "ON" position the trim is enabled, allowing user to vary the gain and offset of the span range. The gain adjustment allows the user to adjust the span of the meter to any number between 1780 and 20300 (unipolar mode) and -9785 to +9785 (bipolar mode) with the span range setting (see span range table above). If the meter is out of calibration the operator can use the gain or offset adjustment for correction only when one of the span range settings is set, not when displaying the physical input voltage.

TECHNICAL NOTES



1. Calibration

This meter is calibrated at the factory at the time of manufacture. If the meter is out of calibration, the operator can use the gain or offset adjustment (Trim Enable) for correction, only when one of the span range settings is set, not when displaying the physical input voltage. However, calibration may no longer be within datasheet specifications.

2. Protection and Fusing

This meter contains an internal PTC fuse as well as other protective elements that are intended for protection against brief electrical transients and misconnect conditions. Additional external protective components such as fuses and transient suppressors may be required depending on the application in which the meter is deployed.

3. Noisy Power Supplies

In systems with noisy power supplies, connecting an external, non-polarized capacitor across the +VS and -VS inputs can help reduce measurement errors. In certain situations, the use of twisted pair or shield wiring may be required.

4. Installation

IMPORTANT! To ensure safe and reliable operation, this meter must be installed and serviced by qualified technical personnel. Contact Murata Power Solutions if there is any doubt regarding their installation or operation.

5. Over-range Limit

The meter will flash on and off when the meter exceeds its minimum or maximum input current. For example, if the meter is set in the 0-20 mA range, any input current below 0 mA or above 20 mA will cause the display to flash on and off.

PANEL INSTALLATION

Panel Cutout

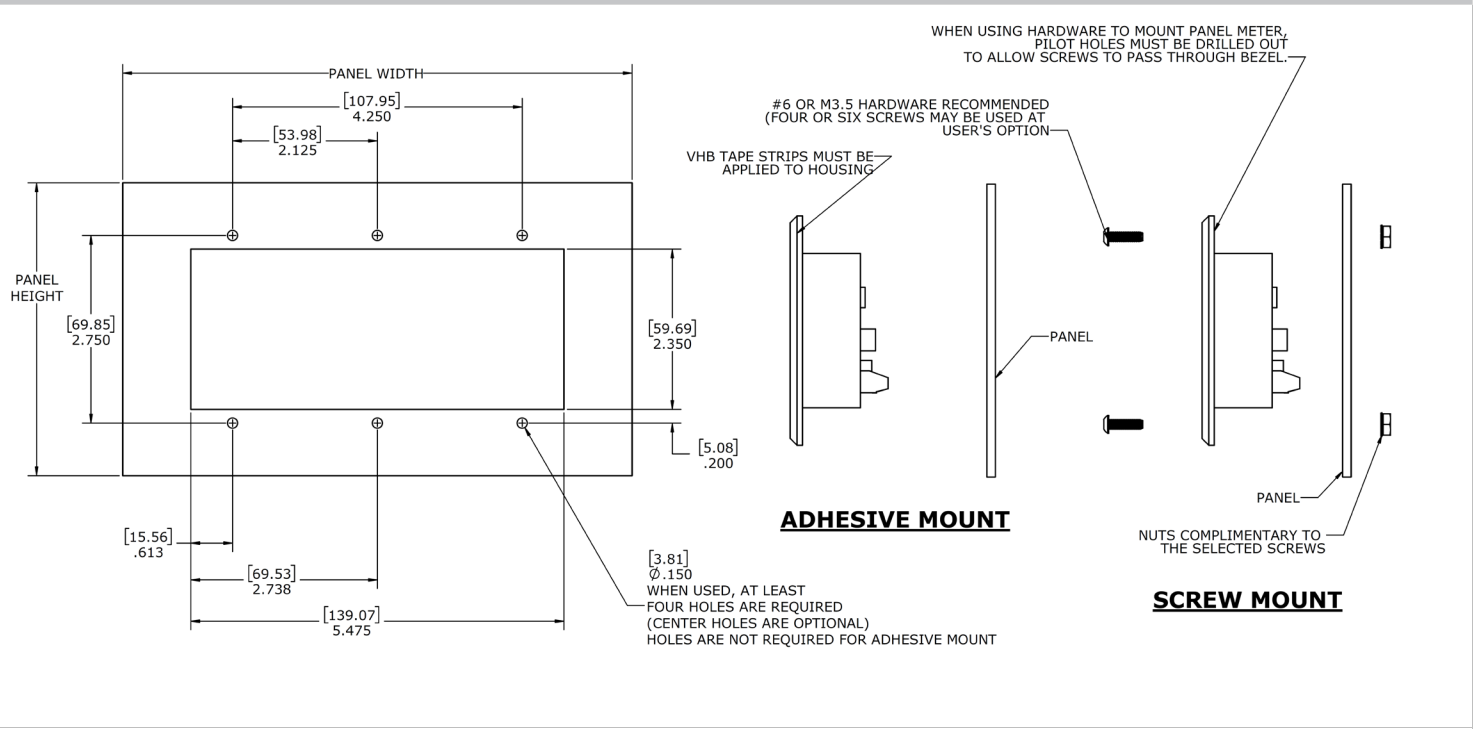

Note: When mounting panel meter with hardware, a four hole pattern (four outermost holes) or the six hole pattern may be used at the customer's option.

MECHANICAL SPECIFICATIONS

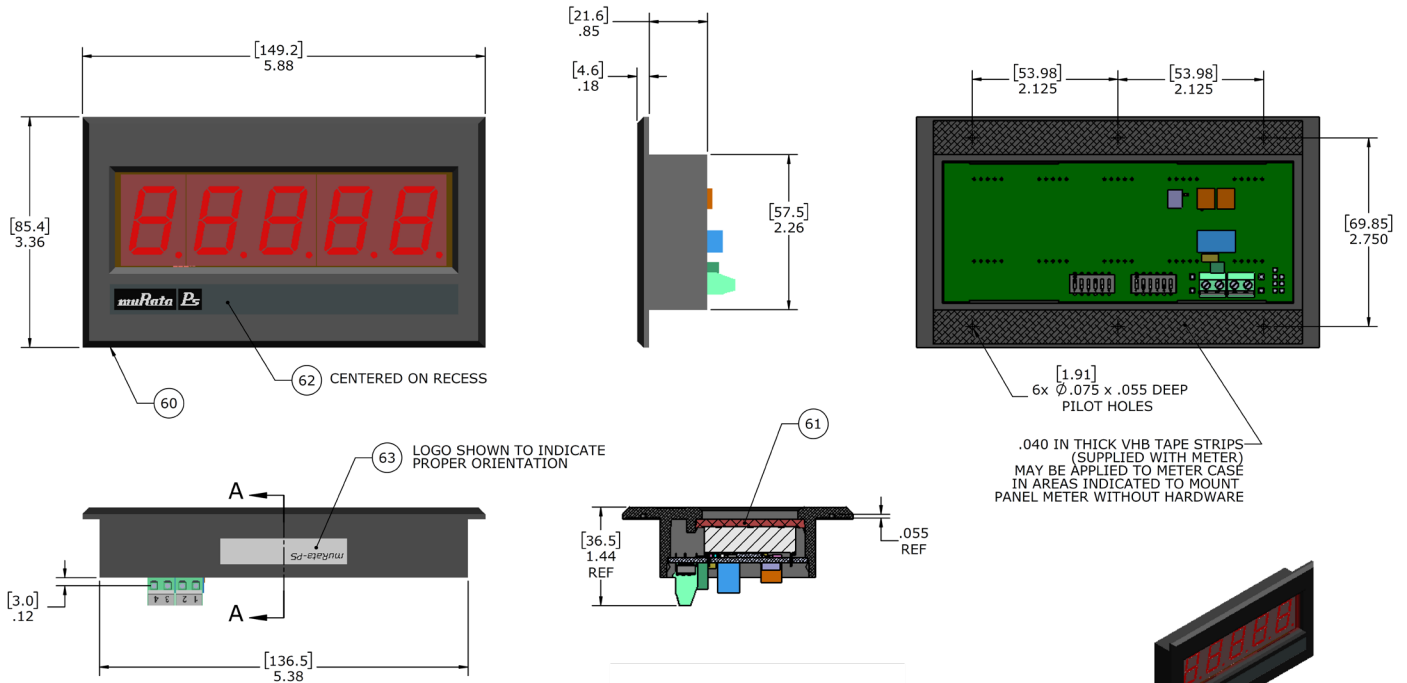

UNLESS OTHERWISE SPECIFIED:
 DIMENSIONS ARE IN INCHES
 TOLERANCES:
 2 PL ± 0.01 3 PL ± 0.005
 ANGLES $\pm 0.5^\circ$

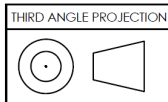

APPLICATION NOTES

Document Number	Description	URL Link to Document
DMS-AN25	Application Note: DMS01 Meter Measurement and Calibration	Click to open application note

Murata Power Solutions, Inc.
 129 Flanders Rd. Westborough, Ma 01581, USA.
 ISO 9001 and 14001 REGISTERED



This product is subject to the following operating requirements and the Life and Safety Critical Application Sales Policy:

Refer to: <https://www.murata-ps.com/requirements/>

Murata Power Solutions, Inc. makes no representation that the use of its products in the circuits described herein, or the use of other technical information contained herein, will not infringe upon existing or future patent rights. The descriptions contained herein do not imply the granting of licenses to make, use, or sell equipment constructed in accordance therewith. Specifications are subject to change without notice.
 ©2020 Murata Power Solutions, Inc.

单击下面可查看定价，库存，交付和生命周期等信息

[>>Murata\(村田\)](#)