

PRODUCT OVERVIEW



DMS01-VM1-RS12-C is a robust, configurable, digital panel meter that provides precise measurement and display of DC voltage on a highly visible red 1" (25mm) tall, 3½ digit seven-segment LED display with adjustable brightness. DIP switches are provided for selectable input voltage range, decimal point placement; Independent trim-potentiometers provide additional precision optimization for specialized applications. An external 12VDC power source provides power to the meter and the internal DC-DC converter accommodates a +/-48V common-mode measurement range with respect to the power supply input, simplifying a wide range of measurement applications. The internal digital filter enhances performance in electrically noisy environments. This digital panel meter is ideal for laboratory instrumentation, factory automation, and any application that requiring precise voltage monitoring.

Features

- Measures DC Volts with user selectable ± 2 VDC or ± 200 mVDC ranges
- Bright 1" red LED display, readable at distance of 80 feet (~24 m)
- Wide common-mode input range (± 48 V)
- Digital filter for optimizing measurements in electrically noisy environments
- Operates from an external 12VDC power supply
- Mounts with adhesive strips (supplied) or screws
- 0.2% typical accuracy
- Adjustable display brightness
- Two-Year Warranty

ORDERING INFORMATION

DMS01-VM1-RS12-C	Digital Voltmeter, 1" Red Display, 12VDC Power
------------------	------------------------------------------------

SIMPLIFIED BLOCK DIAGRAM

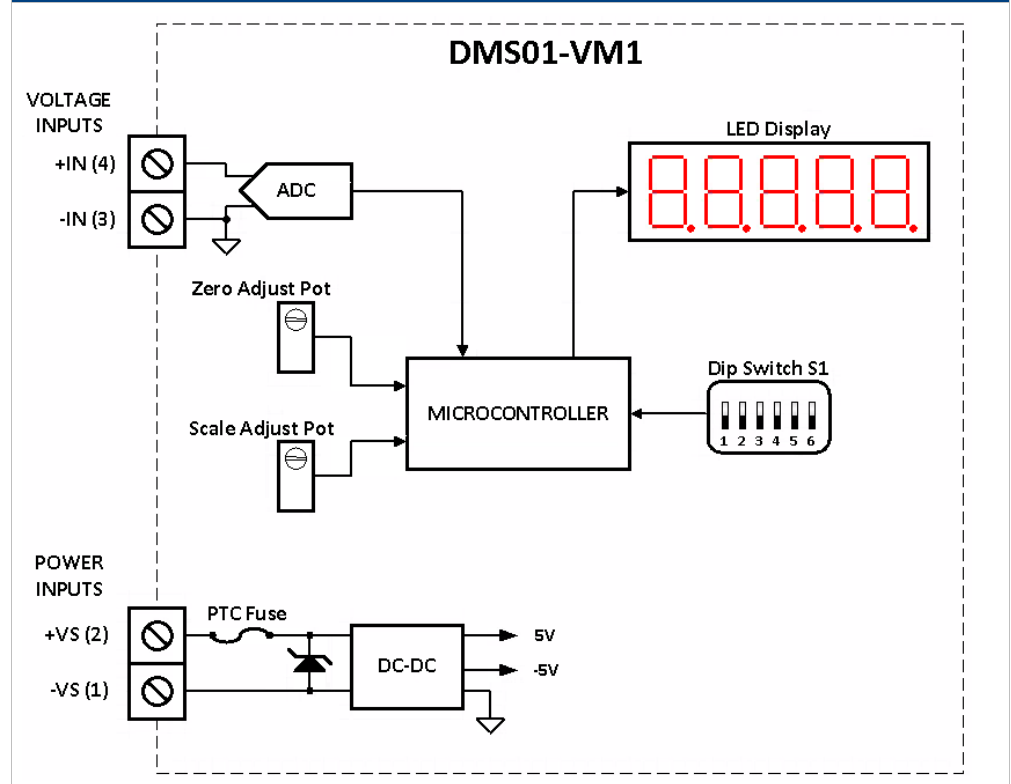

For full details go to
www.murata-ps.com/rohs

DC ELECTRICAL CHARACTERISTICS (Typical @ 25°C, +12VDC supply unless otherwise noted)				
Parameter	Min	Typ	Max	Units
Supply Voltage (Operating)	+11	+12	+13	V
Absolute Maximum Supply Voltage	-1		+14	V
Supply Current ¹ (Operating at maximum intensity)			100	mA
(Operating at maximum intensity)			60	mA
Digits		3.5		
Digit Height		1 (25.4)		inch (mm)
Display Update Rate		2.5		Sa/s
Decimal Selection		Manual/Auto		
Display Color		Red (627nm pk)		
Over-range Indication		Flashing Display		
Measurement range (200mV range)	-200		+200	mV
(2V range)	-2		+2	V
Accuracy		0.2%	1%	
Zero-Offset (200mV range)	-2		+2	count
(2V range)	-2		+2	count
Input Impedance		5G		Ω
Offset Trim Range		±2		% full-scale
Scale Trim Range		±1		%
Temperature Drift (0 to +50°C)		±0.01		count/°C
Absolute Maximum Input Voltage (+VIN to -VIN)	-30		+30	V
Common-mode Input Range (-VIN) – (-VS)	-48		+48	V

¹ based on a display value of "1.888"

PHYSICAL/ENVIRONMENTAL				
Parameter	Min	Typ	Max	Units
Operating Temperature	0		+50	C
Storage Temperature	-40		+75	C
Humidity (Non-condensing)			85	%RH
Weight		6.14 (174)		oz (g)
User Controls				
Brightness		single-turn potentiometer		
Offset and Gain Adjustment		QTY 2 12-turn trim potentiometers		
Dipswitch configuration setting for:		"S1" 6-position		
- Input voltage range				
- Digital filter enable				
- Decimal point placement				
- Scale and offset enable				
Overall Dimensions	5.86 (149) L x 3.36 (86) W x 1.43 (37) H			inch (mm)
Terminal Blocks				
	Min	Typ	Max	Units
Wire Size	24		14	AWG
Insulation Strip Length		0.25 (6)		inch (mm)
Screw Tightening Torque		56.6 (0.4)		oz-in (N-m)

OPERATION	
Measurement Type and Capabilities	
➤	The DMS01-VM1 measures DC voltage with two user-selectable input ranges of ±50mV and ±100mV.
➤	Measurements are displayed with 3-1/2 digits of resolution.
➤	A high-impedance input helps maintain accuracy with a variety of signal sources.
➤	The meter's measurement terminals are electrically isolated from the power terminals through a DC-DC converter, providing a high common-mode input range (+/-48V) for the input (relative to the power terminals), simplifying a wide range of measurement applications.
➤	Meter requires external 12VDC power (not included).

REAR PANEL LAYOUT: SCREW TERMINAL CONNECTIONS & CONTROLS

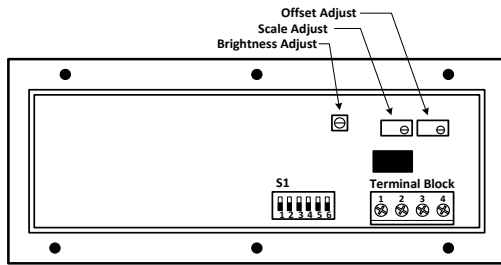

Terminal Block		
Terminal #	Name	Function
1	-VS	Power Supply Terminals (+12VDC)
2	+VS	
3	-IN	Measurement Input Terminals
4	+IN	

Brightness Adjust – This single-turn potentiometer supports adjustment of the meter’s LED display brightness for maximum readability. Turning the pot clockwise increases brightness, while turning it counterclockwise decreases brightness.

Offset Adjust – This 12-turn potentiometer supports the adjustment of meter offset. In the vast majority of applications, this function is not needed as the meter’s offset is precisely adjusted to zero at factory calibration. Turning the pot clockwise will give a negative offset, while turning it counterclockwise give a positive offset.

Scale Adjust – This 12-turn potentiometer supports the adjustment of the meter’s scale. In the vast majority of applications, this function is not needed as the meter’s scale is precisely adjusted at factory calibration. Turning the pot clockwise decreases the gain, while turning it counterclockwise increases the gain.

S1 – 6-position dipswitch used to configure the meter’s various options. See [Meter Configuration](#) below for details.



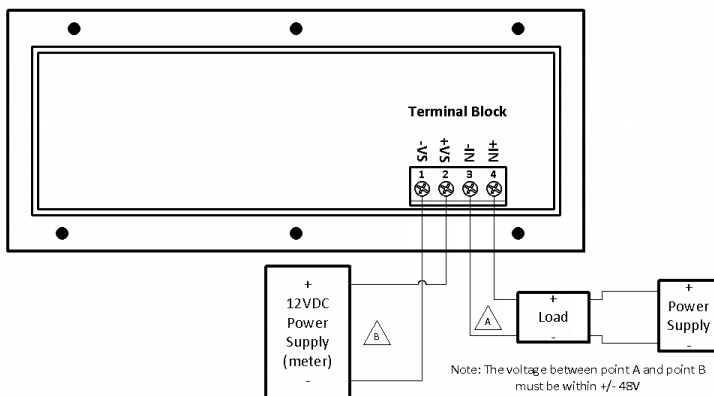





CONNECTION EXAMPLE

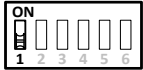
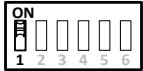

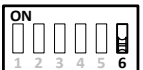
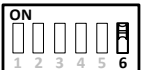
In this example, the load connects to terminals 3 and 4, where terminal 3 is the negative input terminal (-IN) and terminal 4 is the positive input terminal (+IN). The 12V power supply connects to terminals 1 and 2, where terminal 1 is the negative power supply terminal (-VS) and terminal 2 is the positive power supply terminal (+VS).

METER CONFIGURATION

The DMS01-VM1 family is configured through dipswitch S1 on the back of the meter. Each switch on dipswitch S1 is identified by SW#. For example, SW1 is switch 1 on S1, which controls the input range. The following features may be controlled:

Input Range Selection					
Input Range Setting	SW1	Dipswitch			Description
+/-200mV	OFF				SW1 controls the meter's input range. In the OFF position the input range is +/-200mV, while in the ON position the meter's range is +/-2V.
+/-2V	ON				
Digital Filter					
Digital Filter On/Off	SW2	Dipswitch			Description
OFF	OFF				SW2 controls the meter's digital filter. In the OFF position, the filter is disabled and readings are updated at maximum speed. In the ON position, the filter is enabled, and readings are processed through a moving average filter, which results in more stable readings, but a slower response.
ON	ON				
Scale and Offset Adjust					
Trim Enable On/Off	SW6	Dipswitch			Description
OFF	OFF				Scale and Offset Adjust - The DMS01 voltmeter has 2 potentiometers for adjustment of the measurement scale and offset controls which can be enabled by SW6. When the switch is turned to the off position the trim is disabled. When the switch is turned to the on position the trim is enabled.
ON	ON				
Decimal Point Selection					
Decimal Placement	SW3	SW4	SW5	Dipswitch S1	Description
0000	OFF	OFF	OFF		Decimal Point Placement – SW3 through SW5 control the decimal point placement options as shown in the table below. Setting all of the switches to ON enables AUTO mode, which sets the decimal point based on the input range select (SW1): 000.0 for 200mV range and 0.000 for 2V range. Setting only one of the switches on at a time allows the user to choose the decimal place they want.
0.000	ON	OFF	OFF		
00.00	OFF	ON	OFF		
000.0	OFF	OFF	ON		
AUTO	ON	ON	ON		

TECHNICAL NOTES



1. Calibration

The DMS01-VM1 is calibrated at the factory at the time of manufacture. When the Trim Enable switch (SW6) is turned off, the unit ignores the scale and offset potentiometer settings and reverts to factory calibration. When the Trim Enable switch is turned ON, the unit's effective calibration may be changed by the user and may no longer be within datasheet specifications.

2. Protection and Fusing

The DMS01-VM1 contains an internal PTC fuse as well as other protective elements that are intended for protection against brief electrical transients and misconnect conditions. Additional external protective components such as fuses and transient suppressors may be required depending on the application in which the meter is deployed.

3. Noisy Power Supplies

In systems with noisy power supplies, connecting an external, non-polarized capacitor across the +VS and -VS inputs can help reduce measurement errors. In certain situations, the use of twisted pair or shield wiring may be required.

4. Installation

IMPORTANT! To ensure safe and reliable operation, DMS01 meters must be installed and serviced by qualified technical personnel. Contact Murata Power Solutions if there is any doubt regarding their installation or operation.

5. Over-Range Limit

The meter will flash on and off when the input of the meter exceeds its minimum or maximum input voltage/current.

PANEL INSTALLATION

Panel Cutout

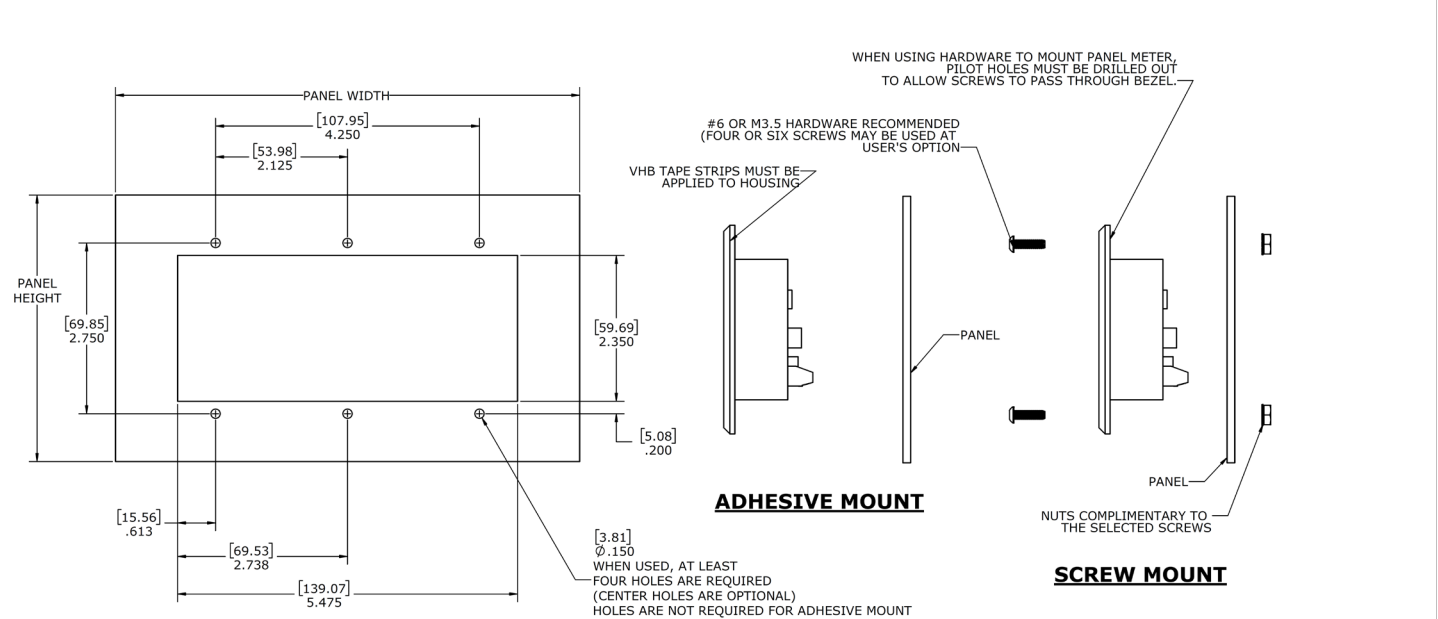

Note: When mounting panel meter with hardware, a four hole pattern (four outermost holes) or the six hole pattern may be used at the customer's option.

MECHANICAL SPECIFICATIONS

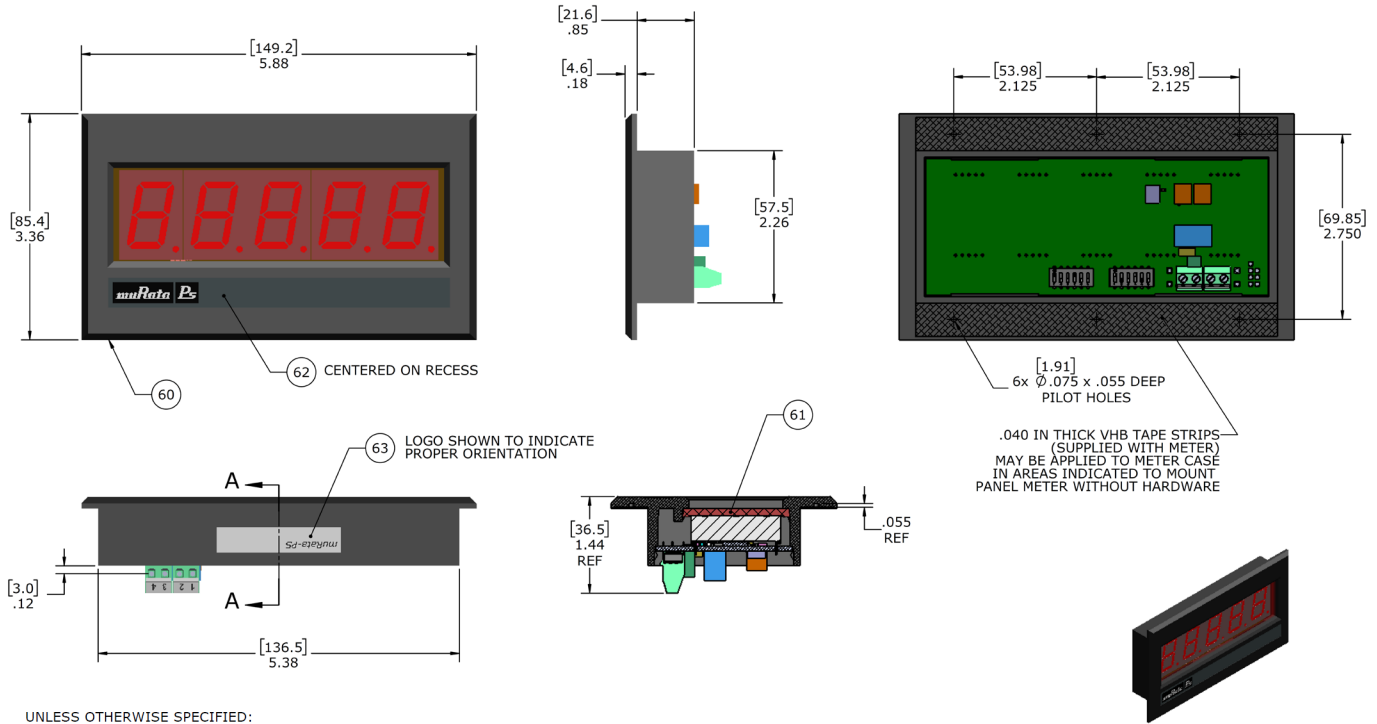

UNLESS OTHERWISE SPECIFIED:
 DIMENSIONS ARE IN INCHES
 TOLERANCES:
 2 PL ± 0.01 3 PL ± 0.005
 ANGLES $\pm 0.5^\circ$

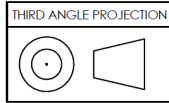

APPLICATION NOTES

Document Number	Description	URL Link to Document
DMS-AN25	Application Note: DMS01 Meter Measurement and Calibration	Click to open application note

Murata Power Solutions, Inc.
 129 Flanders Rd. Westborough, Ma 01581, USA.
 ISO 9001 and 14001 REGISTERED



This product is subject to the following operating requirements and the Life and Safety Critical Application Sales Policy:
 Refer to: <https://www.murata-ps.com/requirements/>

Murata Power Solutions, Inc. makes no representation that the use of its products in the circuits described herein, or the use of other technical information contained herein, will not infringe upon existing or future patent rights. The descriptions contained herein do not imply the granting of licenses to make, use, or sell equipment constructed in accordance therewith. Specifications are subject to change without notice.
 ©2020 Murata Power Solutions, Inc..

单击下面可查看定价，库存，交付和生命周期等信息

[>>Murata\(村田\)](#)