



**FEATURES**

- RoHS compliant
- Efficiency to 85%
- Power density up to 0.85W/cm<sup>3</sup>
- Single or dual output
- UL 94V-0 package material
- No heatsink required
- Footprint from 1.17cm<sup>2</sup>
- Industry standard pinout
- Power sharing on dual output
- 3kVDC isolation (1 minute)
- 24V & 48V input
- 5V, 9V, 12V and 15V output
- Internal SMD construction
- Fully encapsulated with toroidal magnetics
- No external components required
- No electrolytic or tantalum capacitors

**DESCRIPTION**

The NMV series offers single or dual output versions in the same size package as the popular NMA series. The higher isolation is particularly useful in control type applications where the standard 1kV is not sufficient.

**SELECTION GUIDE**

Order Code	Nominal Input Voltage	Output Voltage	Output Current	Load Regulation (Max)	Ripple & Noise (Max)	Efficiency	Isolation Capacitance	MTTF <sup>1</sup>	Package Style	RECOMMENDED ALTERNATIVES (Click to view the MEV1 data sheet)
	V	V	mA	%	mV p-p	%	pF	kHrs		
<b>NOT RECOMMENDED FOR NEW DESIGNS:</b>										
NMV2412SC	24	±12	±42	10	150	80	65	134	SIP	MEV1D2412SC
NMV2405SAC	24	5	200	15	150	70	33	201	SIP	MEV1S2405SC
<b>OBSOLETE:</b>										
NMV2405DAC	24	5	200	15	150	70	33	201	DIP	MEV1S2405DC
NMV2409DAC	24	9	111	10	150	80	40	185	DIP	MEV1S2409DC
NMV2412DAC	24	12	84	10	150	80	55	163	DIP	MEV1S2412DC
NMV2415DAC	24	15	67	10	150	80	70	136	DIP	MEV1S2415DC
NMV2409SAC	24	9	111	10	150	80	40	185	SIP	MEV1S2409SC
NMV2412SAC	24	12	84	10	150	80	55	163	SIP	MEV1S2412SC
NMV2415SAC	24	15	67	10	150	80	70	136	SIP	MEV1S2415SC
NMV4805DAC	48	5	200	15	150	70	48	213	DIP	MEV1S4805SC
NMV4809DAC	48	9	111	10	150	80	59	194	DIP	MEV1S4809SC
NMV4812DAC	48	12	84	10	150	80	70	169	DIP	MEV1S4812SC
NMV4815DAC	48	15	67	10	150	80	81	140	DIP	MEV1S4815SC
NMV4805SAC	48	5	200	15	150	70	48	213	SIP	MEV1S4805SC
NMV4809SAC	48	9	111	10	150	80	59	194	SIP	MEV1S4809SC
NMV4812SAC	48	12	84	10	150	80	70	169	SIP	MEV1S4812SC
NMV4815SAC	48	15	67	10	150	80	81	140	SIP	MEV1S4815SC
NMV2405DC	24	±5	±100	15	150	70	45	194	DIP	MEV1D2405DC
NMV2409DC	24	±9	±55	10	150	80	52	166	DIP	MEV1D2409DC
NMV2412DC	24	±12	±42	10	150	80	65	134	DIP	MEV1D2412DC
NMV2415DC	24	±15	±33	10	150	80	70	101	DIP	MEV1D2415DC
NMV2405SC	24	±5	±100	15	150	70	45	194	SIP	MEV1D2405SC
NMV2409SC	24	±9	±55	10	150	80	52	166	SIP	MEV1D2409SC
NMV2415SC	24	±15	±33	10	150	80	70	101	SIP	MEV1D2415SC
NMV4805DC	48	±5	±100	15	150	70	45	205	DIP	MEV1D4805SC
NMV4809DC	48	±9	±55	10	150	80	58	175	DIP	MEV1D4809SC
NMV4812DC	48	±12	±42	10	150	80	68	137	DIP	MEV1D4812SC
NMV4815DC	48	±15	±33	10	150	80	75	102	DIP	MEV1D4815SC
NMV4805SC	48	±5	±100	15	150	70	45	205	SIP	MEV1D4805SC
NMV4809SC	48	±9	±55	10	150	80	58	175	DIP	MEV1D4809SC
NMV4812SC	48	±12	±42	10	150	80	68	137	DIP	MEV1D4812SC
NMV4815SC	48	±15	±33	10	150	80	75	102	DIP	MEV1D4815SC

**INPUT CHARACTERISTICS**

Parameter	Conditions	Min.	Typ.	Max.	Units
Voltage range	Continuous operation, 24V input types	21.6	24	26.4	V
	Continuous operation, 48V input types	43.2	48	52.8	

1. Calculated using MIL-HDBK-217F with nominal input voltage at full load.
  2. Supply voltage must be discontinued at the end of the short circuit duration.
- All specifications typical at T<sub>a</sub>=25°C, nominal input voltage and rated output current unless otherwise specified.



### ABSOLUTE MAXIMUM RATINGS

Short-circuit protection <sup>2</sup>	1 second
Lead temperature 1.5mm from case for 10 seconds	300°C
Input voltage $V_{IN}$ , NMV24 types	28V
Input voltage $V_{IN}$ , NMV48 types	54V

### OUTPUT CHARACTERISTICS

Parameter	Conditions	Min.	Typ.	Max.	Units
Rated Power <sup>1</sup>	$T_A=0^{\circ}\text{C}$ to $70^{\circ}\text{C}$			1	W
Voltage Set Point Accuracy	See tolerance envelope				
Line regulation	High $V_{IN}$ to low $V_{IN}$			1.2	%/%

### ISOLATION CHARACTERISTICS

Parameter	Conditions	Min.	Typ.	Max.	Units
Isolation test voltage	Flash tested for 1 minute	3000			VDC
Resistance	Viso= 1000VDC	1			GΩ

### GENERAL CHARACTERISTICS

Parameter	Conditions	Min.	Typ.	Max.	Units
Switching frequency	All input types		100		kHz

### TEMPERATURE CHARACTERISTICS

Parameter	Conditions	Min.	Typ.	Max.	Units
Specification	All output types	0		70	°C
Storage		-55		150	
Cooling	Free air convection				

### TEMPERATURE DERATING GRAPH

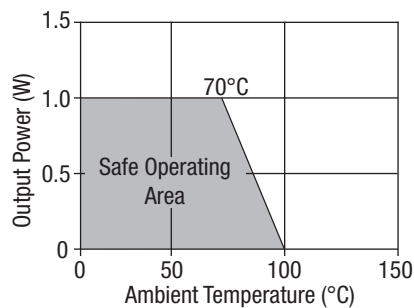

### TOLERANCE ENVELOPE

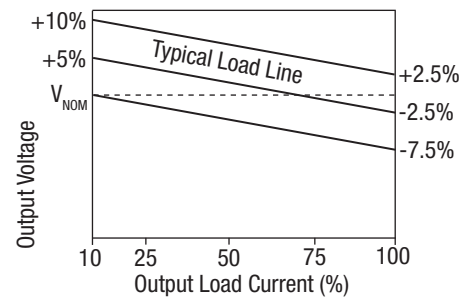

### TECHNICAL NOTES

#### ISOLATION VOLTAGE

'Hi Pot Test', 'Flash Tested', 'Withstand Voltage', 'Proof Voltage', 'Dielectric Withstand Voltage' & 'Isolation Test Voltage' are all terms that relate to the same thing, a test voltage, applied for a specified time, across a component designed to provide electrical isolation, to verify the integrity of that isolation.

Murata Power Solutions NMV series of DC/DC converters are all 100% production tested at their stated isolation voltage. This is 3kVDC for 1 minute.

A question commonly asked is, "What is the continuous voltage that can be applied across the part in normal operation?"

For a part holding no specific agency approvals, such as the NMV series, both input and output should normally be maintained within SELV limits i.e. less than 42.4V peak, or 60VDC. The isolation test voltage represents a measure of immunity to transient voltages and the part should never be used as an element of a safety isolation system. The part could be expected to function correctly with several hundred volts offset applied continuously across the isolation barrier; but then the circuitry on both sides of the barrier must be regarded as operating at an unsafe voltage and further isolation/insulation systems must form a barrier between these circuits and any user-accessible circuitry according to safety standard requirements.

#### REPEATED HIGH-VOLTAGE ISOLATION TESTING

It is well known that repeated high-voltage isolation testing of a barrier component can actually degrade isolation capability, to a lesser or greater degree depending on materials, construction and environment. The NMV series has toroidal isolation transformers, with no additional insulation between primary and secondary windings of enameled wire. While parts can be expected to withstand several times the stated test voltage, the isolation capability does depend on the wire insulation. Any material, including this enamel (typically polyurethane) is susceptible to eventual chemical degradation when subject to very high applied voltages thus implying that the number of tests should be strictly limited. We therefore strongly advise against repeated high voltage isolation testing, but if it is absolutely required, that the voltage be reduced by 20% from specified test voltage.

This consideration equally applies to agency recognized parts rated for better than functional isolation where the wire enamel insulation is always supplemented by a further insulation system of physical spacing or barriers.

## PACKAGE SPECIFICATIONS

### MECHANICAL DIMENSIONS

DIP package

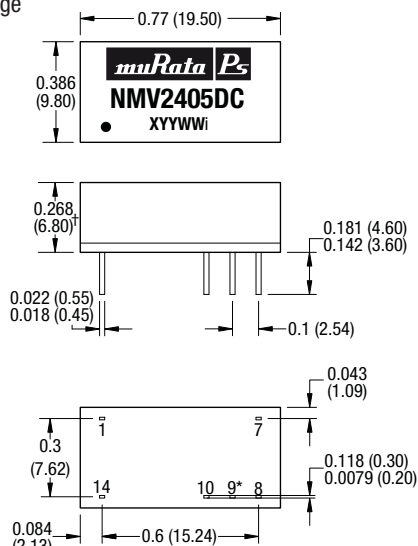

SIP package

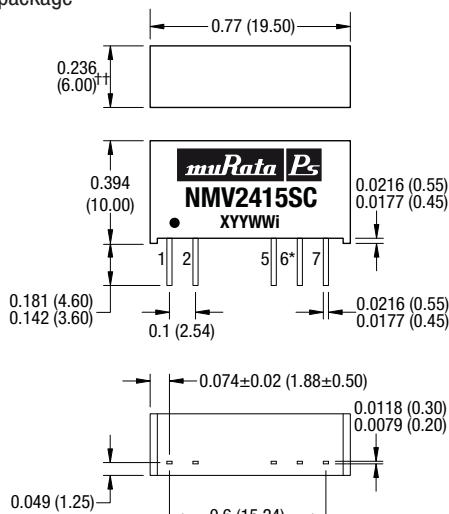

† 0.303 (7.70) for 48V variants  
 †† 0.300 (7.50) for 48V variants

\* Pin not fitted on single output variants.

All dimensions in inches ±0.01 (mm ±0.25mm). All pins on a 0.1 (2.54) pitch and within ±0.01 (0.25) of true position.

Weight: 2.11g (DIP and SIP)

### PIN CONNECTIONS

Single output variants

14 Pin DIP		7 Pin SIP	
Pin	Function	Pin	Function
1	-V <sub>IN</sub>	1	+V <sub>IN</sub>
7	NC	2	-V <sub>IN</sub>
8	+V <sub>OUT</sub>	5	-V <sub>OUT</sub>
10	-V <sub>OUT</sub>	7	+V <sub>OUT</sub>
14	+V <sub>IN</sub>		

Dual output variants

14 Pin DIP		7 Pin SIP	
Pin	Function	Pin	Function
1	-V <sub>IN</sub>	1	+V <sub>IN</sub>
7	NC	2	-V <sub>IN</sub>
8	+V <sub>OUT</sub>	5	-V <sub>OUT</sub>
9	OV	6	OV
10	-V <sub>OUT</sub>	7	+V <sub>OUT</sub>
14	+V <sub>IN</sub>		

**PACKAGE SPECIFICATIONS (continued)**

**RECOMMENDED FOOTPRINT DETAILS**

14 Pin DIP Package

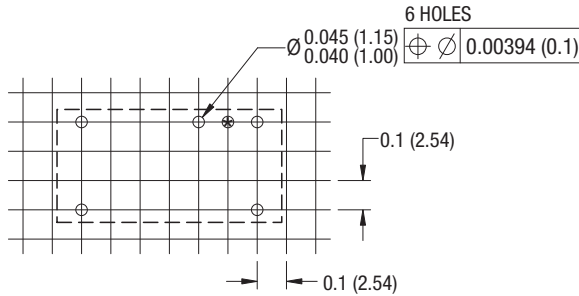

7 Pin SIP Package

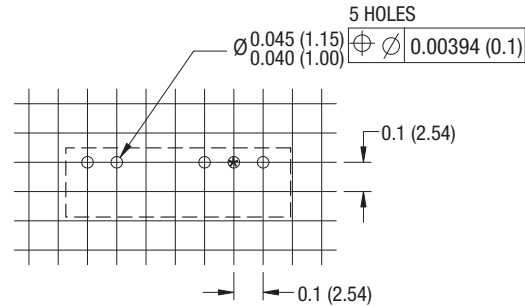

\*Hole not required for single output variants.

**TUBE OUTLINE DIMENSIONS**

14 Pin DIP Tube

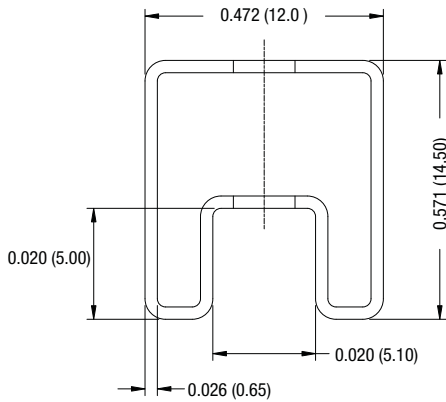

7 Pin SIP Tube

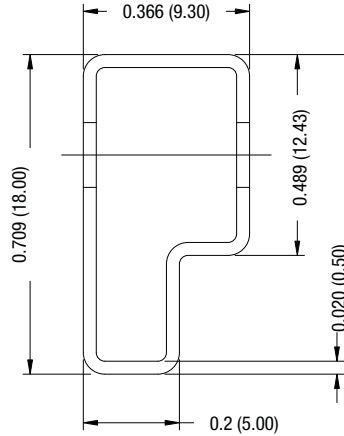

Unless otherwise stated all dimensions in inches (mm)  $\pm 0.5$ mm.  
 Tube length (14 Pin DIP) : 20.47 (520mm  $\pm 2$ mm).  
 Tube length (7 Pin SIP) : 20.47 (520mm  $\pm 2$ mm).

Tube Quantity : 25

**RoHS COMPLIANCE INFORMATION**



This series is compatible with RoHS soldering systems with a peak wave solder temperature of 300°C for 10 seconds. The pin termination finish on the SIP package type is Tin Plate, Hot Dipped over Matte Tin with Nickel Preplate. The DIP types are Matte Tin over Nickel Preplate. Both types in this series are backward compatible with Sn/Pb soldering systems.  
 For further information, please visit [www.murata-ps.com/rohs](http://www.murata-ps.com/rohs)

Murata Power Solutions, Inc.  
 11 Cabot Boulevard, Mansfield, MA 02048-1151 U.S.A.  
 ISO 9001 and 14001 REGISTERED



**This product is subject to the following operating requirements and the Life and Safety Critical Application Sales Policy:  
 Refer to: <http://www.murata-ps.com/requirements/>**

Murata Power Solutions, Inc. makes no representation that the use of its products in the circuits described herein, or the use of other technical information contained herein, will not infringe upon existing or future patent rights. The descriptions contained herein do not imply the granting of licenses to make, use, or sell equipment constructed in accordance therewith. Specifications are subject to change without notice.  
 © 2012 Murata Power Solutions, Inc.

单击下面可查看定价，库存，交付和生命周期等信息

[>>Murata\(村田\)](#)