

- **Ideal for European 868.35 MHz Transmitters**
- **Very Low Series Resistance**
- **Quartz Stability**

The RO3164E is a true one-port, surface-acoustic-wave (SAW) resonator in a surface-mount ceramic case. It provides reliable, fundamental-mode, quartz frequency stabilization of fixed-frequency transmitters operating at 868.35 MHz. This SAW is designed specifically for remote-control and wireless security transmitters operating under ETSI-ETS 300 220 in Europe and under FTZ 17 TR 2100 in Germany.

Absolute Maximum Ratings

Rating	Value	Units
Input Power Level	0	dBm
DC Voltage	12	VDC
Storage Temperature	-40 to +125	°C
Operating Temperature Range	-40 to +125	°C
Soldering Temperature	+260	°C

RO3164E/E-1/E-2

**868.35 MHz
SAW Resonator**

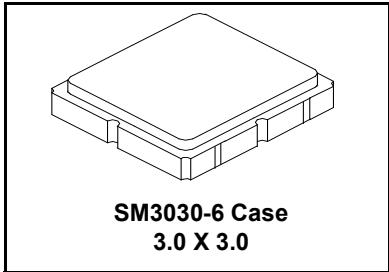

Electrical Characteristics

Characteristic	Sym	Notes	Minimum	Typical	Maximum	Units
Frequency (+25 °C) Nominal Frequency	RO3164E RO3164E-1 RO3164E-2	f_C	868.150		868.550	MHz
			868.200		868.500	
			868.250		868.450	
Tolerance from 868.35 MHz	RO3164E RO3164E-1 RO3164E-2	Δf_C			±200	kHz
					±150	
					±100	
Insertion Loss	IL	2,5,6		1.3	2.0	dB
Quality Factor	Unloaded Q	Q_U		7200		
	50 Ω Loaded Q	Q_L		975		
Temperature Stability	Turnover Temperature	T_O	10	25	40	°C
	Turnover Frequency	f_O	6,7,8	f_C		kHz
	Frequency Temperature Coefficient	FTC		0.032		ppm/°C ²
Frequency Aging	Absolute Value during the First Year	fA	1	<±10		ppm/yr
DC Insulation Resistance between Any Two Terminals		5	1.0			MΩ
RF Equivalent RLC Model	Motional Resistance	R_M		16		Ω
	Motional Inductance	L_M	5, 6, 7, 9	20		μH
	Motional Capacitance	C_M		1.7		fF
	Shunt Static Capacitance	C_O	5, 6, 9	1.6		pF
Test Fixture Shunt Inductance	L_{TEST}	2, 7		20		nH
Lid Symbolization (in addition to Lot and/or Date Codes)	RO3164E 686, RO3164E-1 773, RO3164E-2 774 / YWWS					
Standard Reel Quantity	Reel Size 7 Inch	10	500 Pieces / Reel			
	Reel Size 13 Inch		3000 Pieces / Reel			

 **CAUTION: Electrostatic Sensitive Device. Observe precautions for handling.**

NOTES:

- Frequency aging is the change in f_c with time and is specified at +65°C or less. Aging may exceed the specification for prolonged temperatures above +65°C. Typically, aging is greatest the first year after manufacture, decreasing in subsequent years.
- The center frequency, f_c , is measured at the minimum insertion loss point, IL_{MIN} , with the resonator in the 50 Ω test system ($VSWR \leq 1.2:1$). The shunt inductance, L_{TEST} , is tuned for parallel resonance with C_O at f_c . Typically, $f_{OSCILLATOR}$ or $f_{TRANSMITTER}$ is approximately equal to the resonator f_c .
- One or more of the following United States patents apply: 4,454,488 and 4,616,197.
- Typically, equipment utilizing this device requires emissions testing and government approval, which is the responsibility of the equipment manufacturer. Unless noted otherwise, case temperature $T_C = +25^\circ C \pm 2^\circ C$.
- The design, manufacturing process, and specifications of this device are subject to change without notice.
- Derived mathematically from one or more of the following directly measured parameters: f_c , IL , 3 dB bandwidth, f_c versus T_C , and C_O .
- Turnover temperature, T_O , is the temperature of maximum (or turnover) frequency, f_O . The nominal frequency at any case temperature, T_C , may be calculated from: $f = f_O [1 - FTC (T_O - T_C)^2]$. Typically *oscillator* T_O is approximately equal to the specified *resonator* T_O .
- This equivalent RLC model approximates resonator performance near the resonant frequency and is provided for reference only. The capacitance C_O is the static (nonmotional) capacitance between the two terminals measured at low frequency (10 MHz) with a capacitance meter. The measurement includes parasitic capacitance with "NC" pads unconnected. Case parasitic capacitance is approximately 0.05 pF. Transducer parallel capacitance can be calculated as: $C_P \approx C_O - 0.05$ pF.
- Tape and Reel Standard for ANSI / EIA 481.

Electrical Connections

The SAW resonator is bidirectional and may be installed with either orientation. The two terminals are interchangeable and unnumbered. The callout NC indicates no internal connection. The NC pads assist with mechanical positioning and stability. External grounding of the NC pads is recommended to help reduce parasitic capacitance in the circuit.

Pin	Connection
1	NC
2	Terminal
3	NC
4	NC
5	Terminal
6	NC

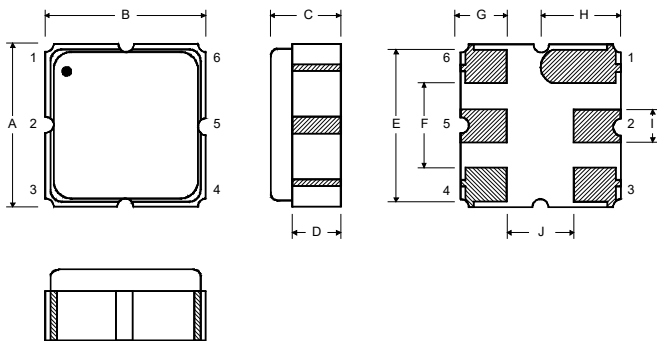

Case Dimensions

Dimension	mm			Inches		
	Min	Nom	Max	Min	Nom	Max
A	2.87	3.0	3.13	0.113	0.118	0.123
B	2.87	3.0	3.13	0.113	0.118	0.123
C	1.12	1.25	1.38	0.044	0.049	0.054
D	0.77	0.90	1.03	0.030	0.035	0.040
E	2.67	2.80	2.93	0.105	0.110	0.115
F	1.47	1.6	1.73	0.058	0.063	0.068
G	0.72	0.85	0.98	0.028	0.033	0.038
H	1.37	1.5	1.63	0.054	0.059	0.064
I	0.47	0.60	0.73	0.019	0.024	0.029
J	1.17	1.30	1.43	0.046	0.051	0.056

Typical Test Circuit

The test circuit inductor, L_{TEST} , is tuned to resonate with the static capacitance, C_O , at f_c .

Electrical Test

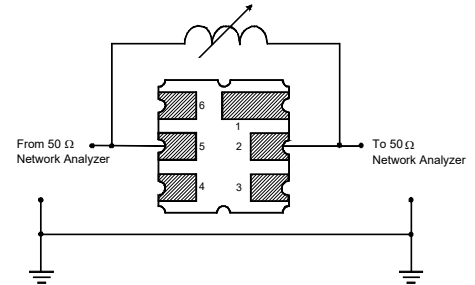

Power Test

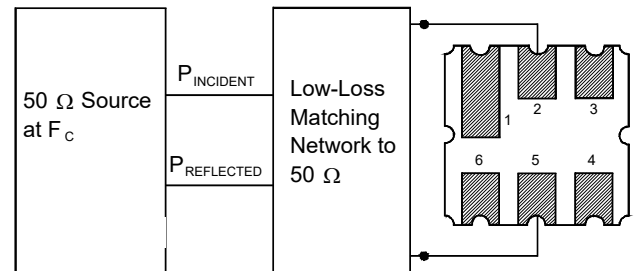

Typical Application Circuits

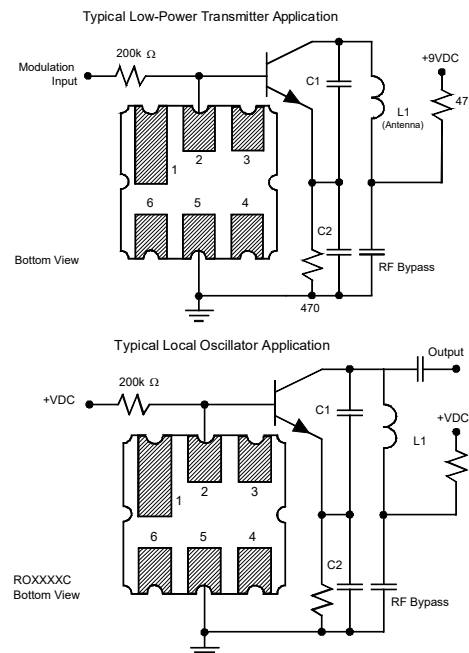

Equivalent LC Model

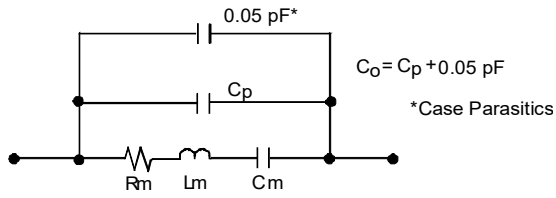

Temperature Characteristics

The curve shown on the right accounts for resonator contribution only and does not include LC component temperature contributions.

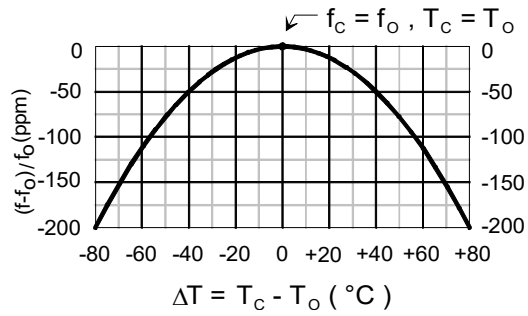

单击下面可查看定价，库存，交付和生命周期等信息

[>>Murata\(村田\)](#)