

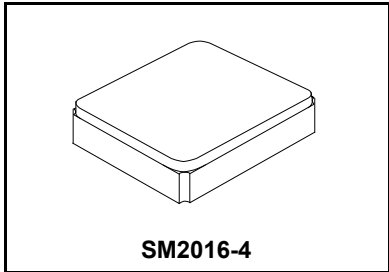

**SF2098H**

**915 MHz  
SAW Filter**



- **Low Insertion Loss**
- **Direct Match to 50 ohms**
- **2.0 x 1.6 mm Surface-mount Case**
- **Complies with Directive 2002/95/EC (RoHS)** 

**Absolute Maximum Ratings**

Rating	Value	Units
Maximum Incident Power in Passband	+15	dBm
Maximum DC Voltage on any Non-ground Terminal	3	VDC
Operating Temperature Range	-40 to +100	°C
Storage Temperature of Device	-40 to +100	°C
Storage Temperature Range in Tape and Reel	-40 to +85	°C
Maximum Soldering Profile (5 cycles maximum)	265°C for 10 s	

**Electrical Characteristics (-40 to +85°C only)**

Characteristic	Sym	Notes	Min	Typ	Max	Units
Center Frequency	$f_C$		915			MHz
Insertion Loss, 902 to 928 MHz	IL			2.0	3.0	dB
Amplitude Ripple, Peak-to-Peak, 902 to 928 MHz				0.8	1.5	
Input/Output Return Loss, 902 to 928 MHz				9.5	8.0	
Group Delay Ripple, Peak-to-Peak, 902 to 928 MHz				35	50	ns
Attenuation Referenced to 0 dB:						dB
10 to 857.5 MHz			40	55		
857.5 to 882.5 MHz			35	48		
970 to 1005 MHz			35	48		
1005 to 1110 MHz			45	52		
1110 to 3000 MHz			30	35		
Source impedance	$Z_S$			50		$\Omega$
Load impedance	$Z_L$			50		$\Omega$
Single-ended Input / Output Impedance Match	No matching network required for operation at 50 ohms					
Case Style	SM2016-4					
Lid Symbolization ( Y=year, W=week)	3H, YW					

 **CAUTION: Electrostatic Sensitive Device. Observe precautions for handling.**

**NOTES:**

1. US and international patents may apply.
2. Murata, stylized Murata logo, and Murata N.A., Inc. are registered trademarks of Murata Manufacturing Co., Ltd.

## Filter Response Plots

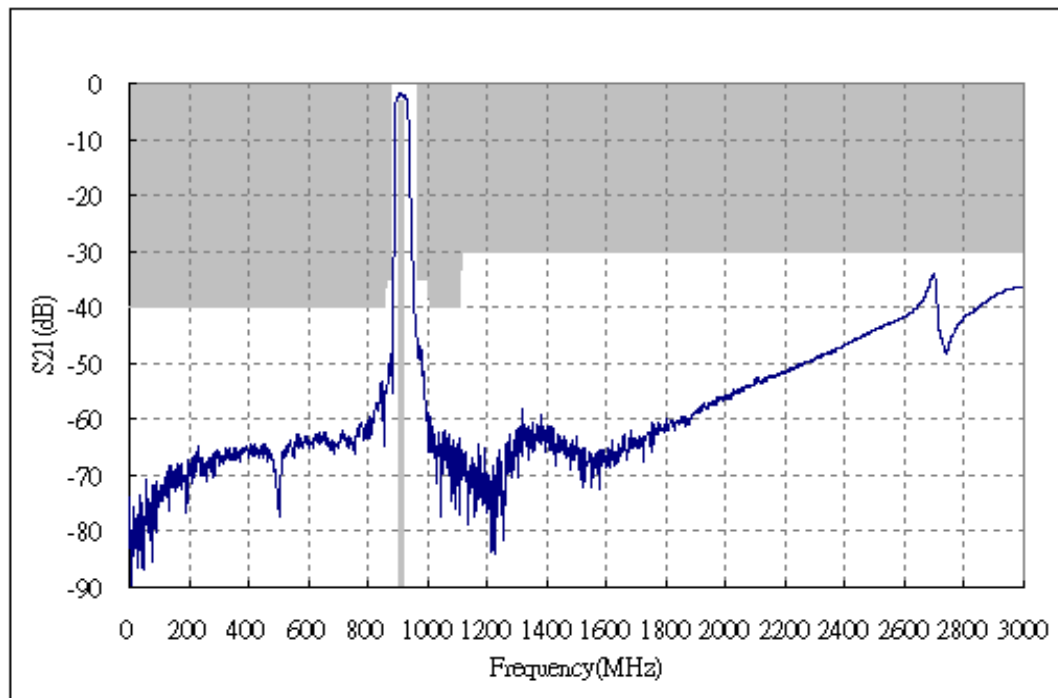
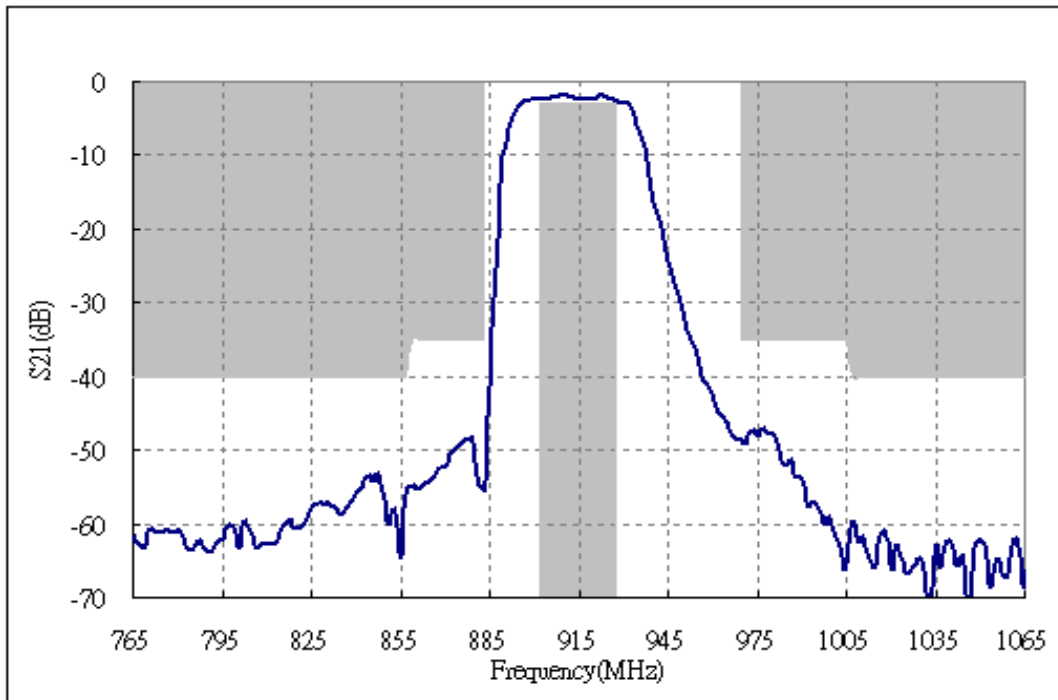

## Passband Amplitude Plot

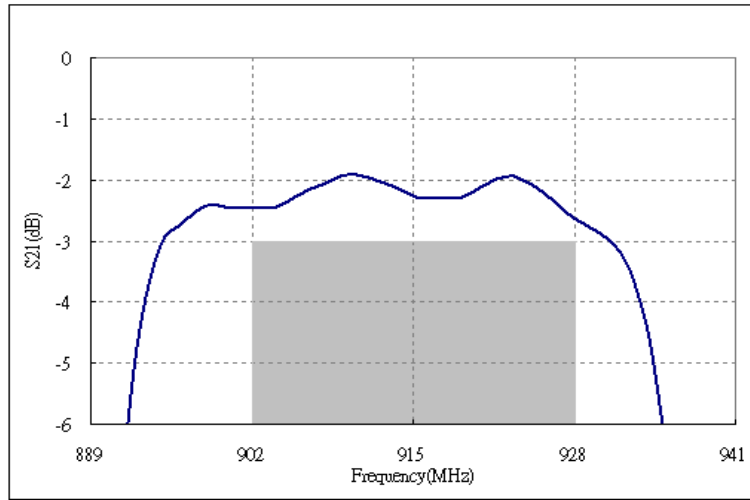

## Passband Group Delay Plot

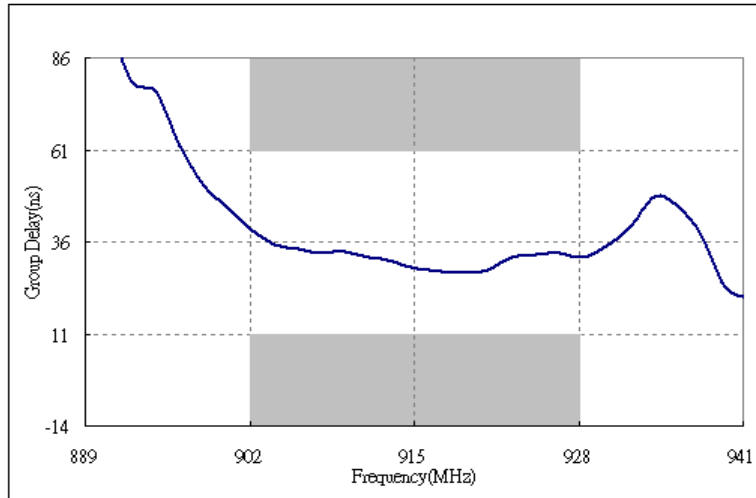

## Passband Return Loss Plot

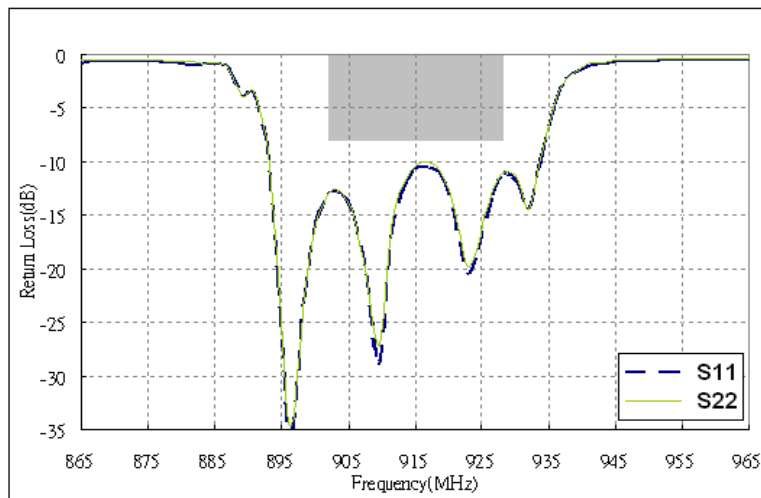

## Input and Output Impedance Plots

▶ **S11** Smith (R+jX) Scale 1.000U [F2]

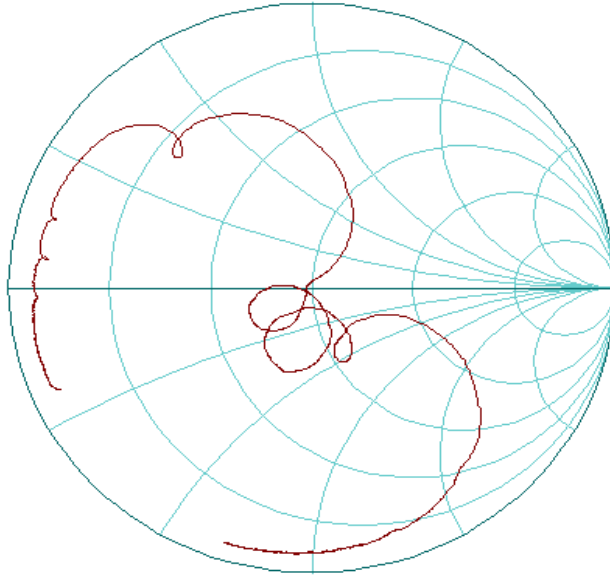

▶ **S22** Smith (R+jX) Scale 1.000U [F2]

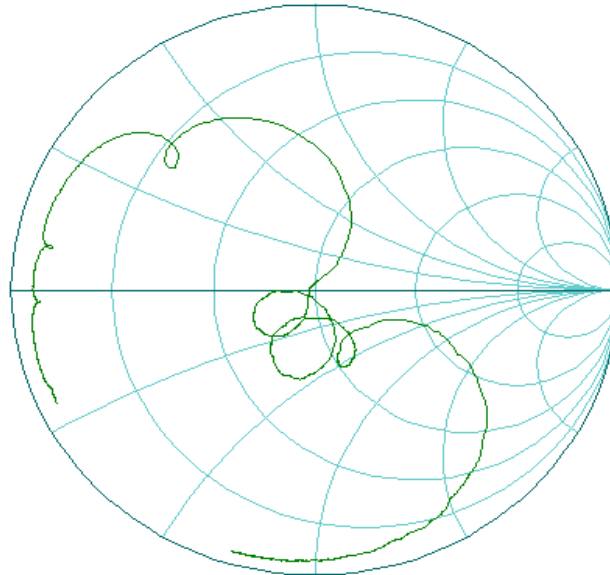

# SM2016-4 Case

## 4-Terminal Ceramic Surface-Mount Case 2.0 X 1.6 mm Nominal Footprint

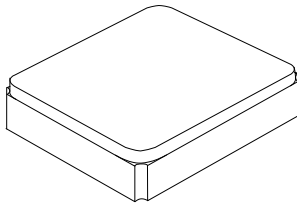

### Electrical Connections

Connection	Terminals
Input	1
Output	3
Ground	2, 4

Dimensions	Millimeters			Inches		
	Min	Nom	Max	Min	Nom	Max
A	1.57	1.60	1.73	0.062	0.063	0.068
B	1.97	2.00	2.13	0.078	0.079	0.084
C	0.55	0.65	0.75	0.021	0.025	0.029
D		0.10			0.004	
E		0.10			0.004	
F	0.57	0.70	0.83	0.022	0.028	0.033
G	0.37	0.50	0.63	0.015	0.020	0.025
H		0.10			0.004	

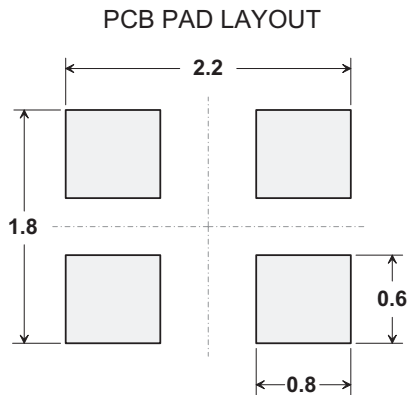

Dimensions in mm  
All pads have the same dimensions

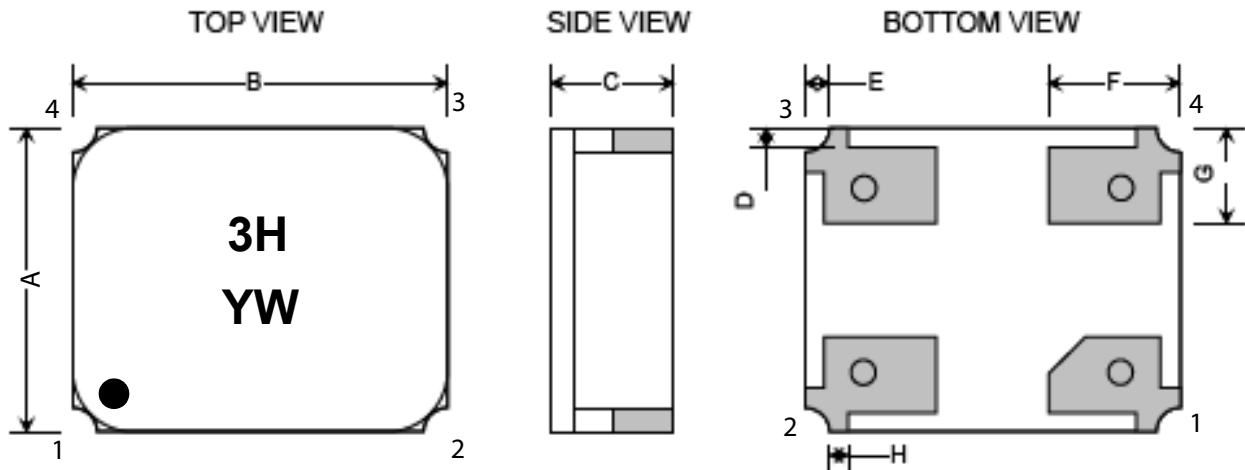

## Reel Dimensions

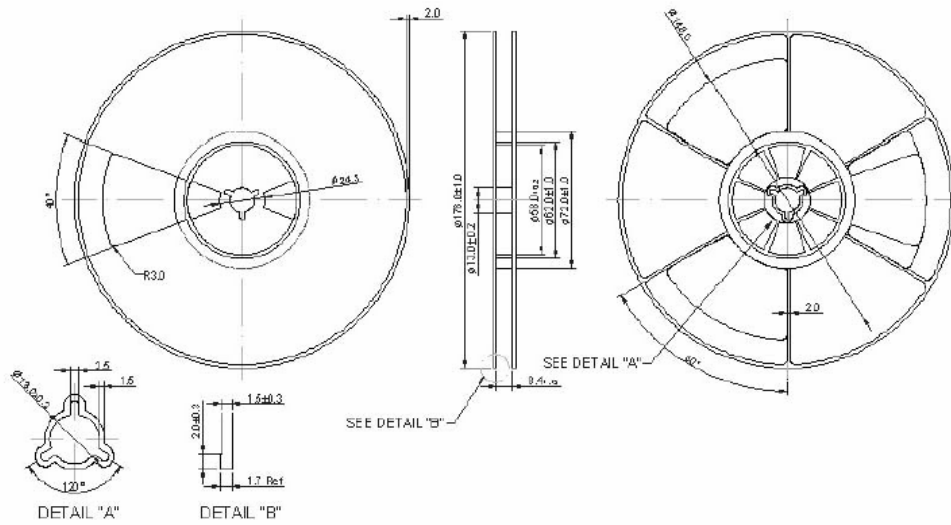

## 2. TAPE DIMENSION

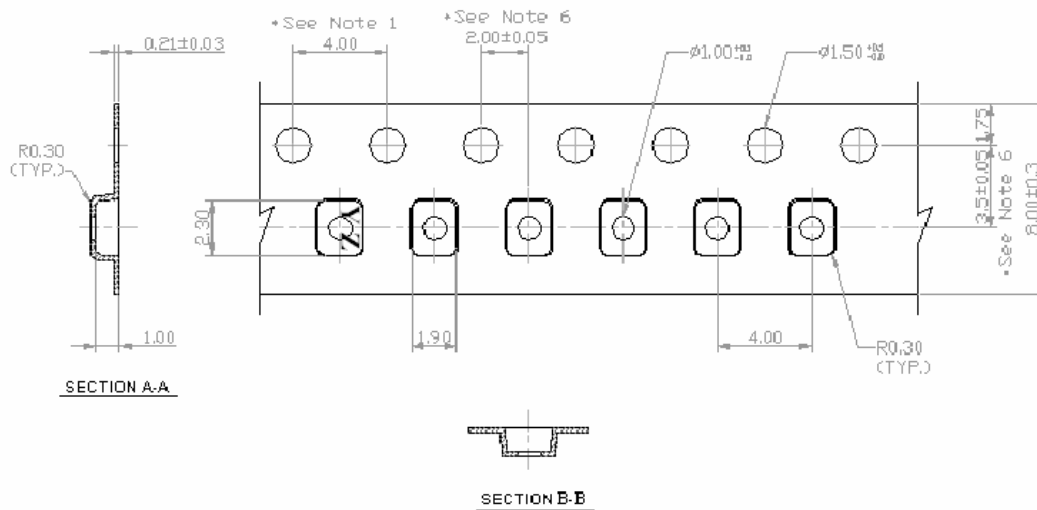

单击下面可查看定价，库存，交付和生命周期等信息

[>>Murata\(村田\)](#)