

SF2143B

**72.54 / 80.46 MHz
SAW Diplexer**

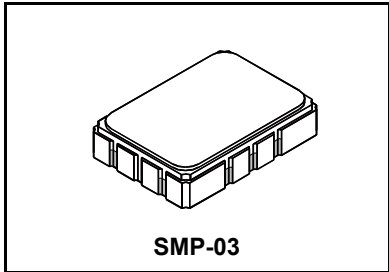

- **Designed for SDARS IF**
- **SAW Diplexer 72.54 MHz / 80.46 MHz**
- **5.0 X 7.0 mm Surface-mount Case**
- **Complies with Directive 2002/95/EC (RoHS)**



Absolute Maximum Ratings

Rating	Value	Units
Maximum Incident Power in Passband	+10	dBm
Maximum DC Voltage Between any Two Terminals	0	VDC
Operating Temperature Range	-40 to +105	°C
Storage Temperature Range in Tape and Reel	-40 to +85	°C
Peak Solder Reflow Temperature, 10 seconds/5 cycles	260	°C

Electrical Characteristics TDM1 Filter

Characteristic	Sym	Notes	Min	Typ	Max	Units
Nominal Center Frequency	f_C	1		72.54		MHz
Passband Width:	BW_1		3.7	4.1		MHz
	BW_{15}			6.4	6.7	MHz
	BW_{30}			7.3	7.5	MHz
Passband Minimum Insertion Loss (including matching network) at f_C	IL_{MIN}			16	18	dB
Amplitude Ripple, $f_C \pm 1.85$ MHz				0.6	1.3	dB _{P-P}
Attenuation Relative to Minimum Insertion Loss:			40	42		dB
	50.00 to 66.48 MHz			42		dB
	66.48 to 68.08 MHz		37	42		dB
	77.30 to 78.60 MHz		30	33		dB
	78.60 to 86.50 MHz		30	33		dB
	86.50 to 91.50 MHz		39	43		dB
	91.50 to 100.0 MHz		42	46		dB
Group Delay Ripple				30	150	nSP-P
Source Impedance, Differential			27 ohms or 200 ohms			
Load Impedance, Differential			1K ohms or 1.5K ohms			

Electrical Characteristics TDM2 Filter

Characteristic	Sym	Notes	Min	Typ	Max	Units
Nominal Center Frequency	f_C	1		80.46		MHz
Passband Width:	BW_1		3.7	4.2		MHz
	BW_{15}			6.4	6.7	MHz
	BW_{30}			7.2	7.5	MHz
Passband Minimum Insertion Loss (including the matching network) at f_C	IL_{MIN}			15	18	dB
Amplitude Ripple, $f_C \pm 1.85$ MHz				0.7	1.3	dB _{P-P}
Attenuation Relative to Minimum Insertion Loss:			39	42		dB
	50.00 to 74.39 MHz			42		dB
	74.39 to 75.99 MHz		33	38		dB
	85.21 to 86.50 MHz		30	38		dB
	86.50 to 91.50 MHz		35	40		dB
	91.50 to 100.0 MHz		43	46		dB
Group Delay Ripple				40	150	nSP-P
Source Impedance, Differential			27 ohms or 200 ohms			
Load Impedance, Differential			1K ohms or 1.5K ohms			

Case Style		6	SMP-03 7 x 5 mm Nominal Footprint
Lid Symbolization (YY=year, WW=week, S=shift) See note 4			RFM SF2143B YYWWWS

CAUTION: Electrostatic Sensitive Device. Observe precautions for handling.

NOTES:

1. Unless noted otherwise, all specifications apply over the operating temperature range with filter soldered to the specified demonstration board with impedance matching to 50 Ω and measured with 50 Ω network analyzer.
2. Unless noted otherwise, all frequency specifications are referenced to the nominal center frequency, f_C .
3. Rejection is measured as attenuation below the minimum IL point in the passband. Rejection in final user application is dependent on PCB layout and external impedance matching design. See Application Note No. 42 for details.
4. "LRIP" or "L" after the part number indicates "low rate initial production" and "ENG" or "E" indicates "engineering prototypes."
5. The design, manufacturing process, and specifications of this filter are subject to change.
6. Tape and Reel Standard ANSI / EIA 481.
7. Either Port 1 or Port 2 may be used for either input or output in the design. However, impedances and impedance matching may vary between Port 1 and Port 2, so that the filter must always be installed in one direction per the circuit design.
8. US and international patents may apply.
9. Murata, stylized Murata logo, and Murata N.A., Inc. are registered trademarks of Murata Manufacturing Co., Ltd.

TDM1 Amplitude and Impedance Plots

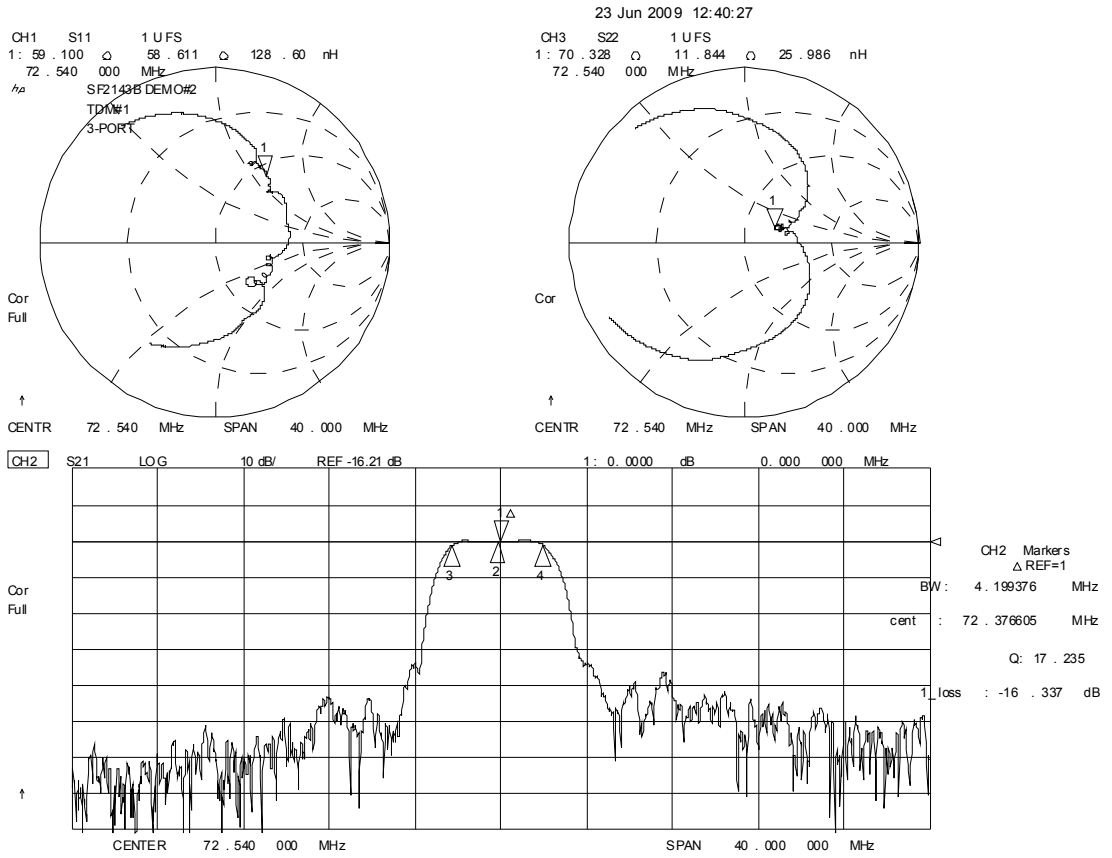

TDM2 Amplitude and Impedance Plots

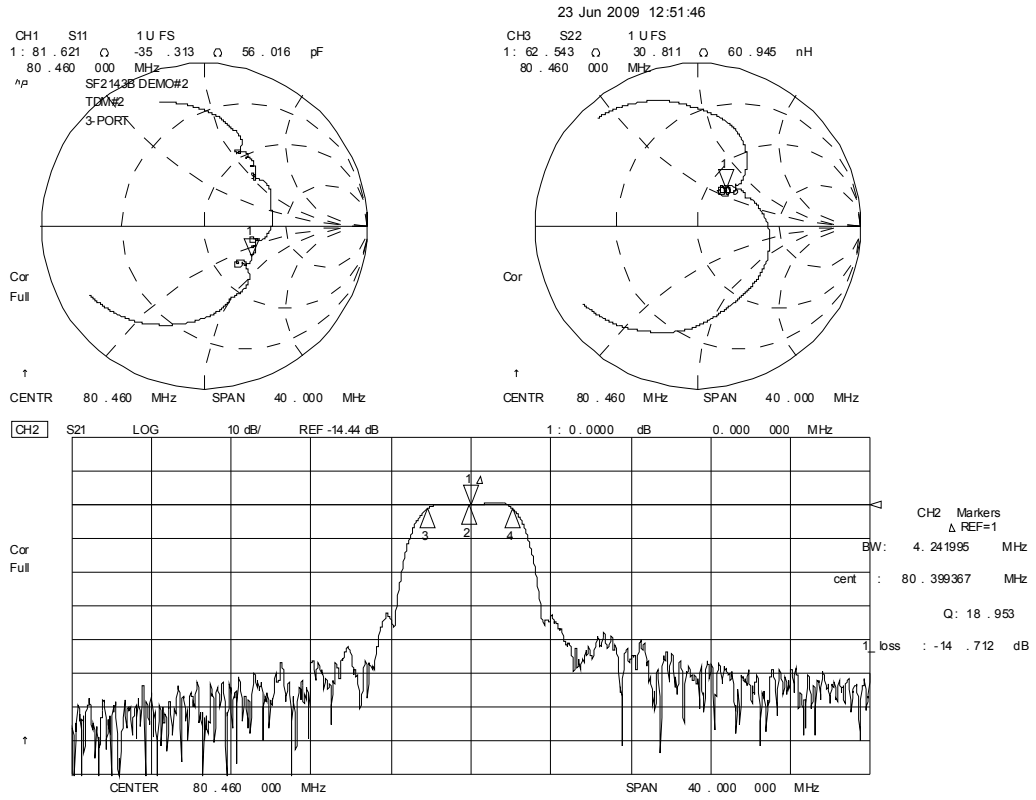

Test Circuit

SF2143B Demo Board

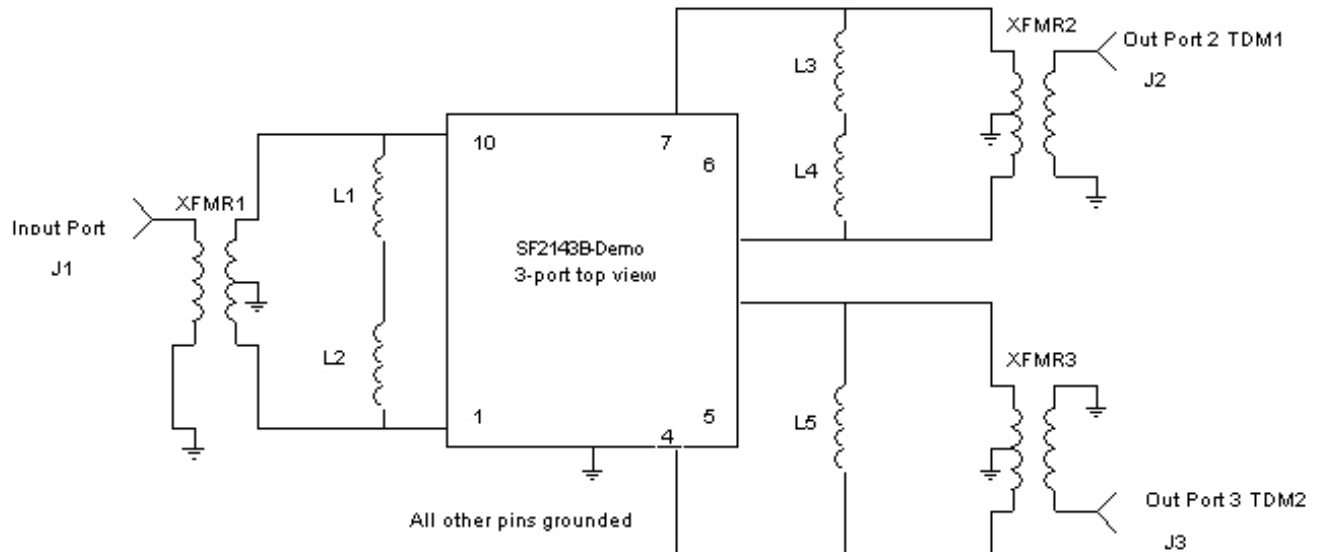

J1-J3	500-0248-002 4 hole flange SMA connector
PCB	400-1768-001 Gold 7 × 5 mm pkg PCB
XFMR2, XFMR3	501-0912-004 16:1 Transformer
XFMR1	501-0912-001 4:1 Transformer

L1	501-0782-101 100nH 0805 Ind
L2	501-0782-270 27nH 0805 Ind
L3	501-0782-390 390nH 0805 Ind
L4	501-0782-120 12nH 0805 Ind
L5	501-0782-331 330 nH 0805 Ind

SMP-03 Case

10-Terminal Ceramic Surface-Mount Case

7 x 5 mm Nominal Footprint

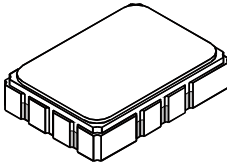

Recommended PCB Footprint

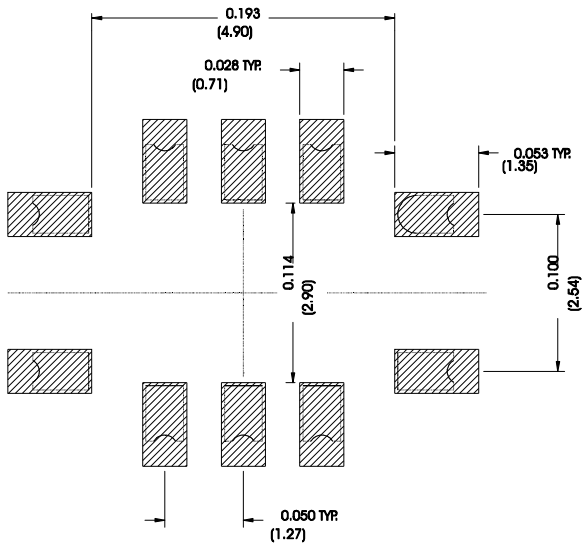

Case Dimensions

Dimension	mm			Inches		
	Min	Nom	Max	Min	Nom	Max
A	6.80	7.00	7.20	0.268	0.276	0.283
B	4.80	5.00	5.20	0.189	0.197	0.205
C	-	1.65	2.00	-	0.065	0.079
D	0.47	0.60	0.73	0.019	0.024	0.029
E	2.41	2.54	2.67	0.095	0.100	0.105
H	0.87	1.00	1.13	0.034	0.039	0.044
J	4.87	5.00	5.13	0.192	0.197	0.202
K	2.87	3.00	3.13	0.113	0.118	0.123
P	1.14	1.27	1.40	0.045	0.050	0.055

Electrical Connections

Connection		Terminals
Port 1	Input	1
	Input	10
Port 2	Output TDM1	6
	Output TDM1	7
Port 3	Output TDM2	4
	Output TDM2	5
Ground		All others

Materials

Solder Pad Plating	0.3 to 1.0 μm Gold over 1.27 to 8.89 μm Nickel
Lid Plating	2.0 to 3.0 μm Nickel
Body	Al_2O_3 Ceramic
Pb Free	

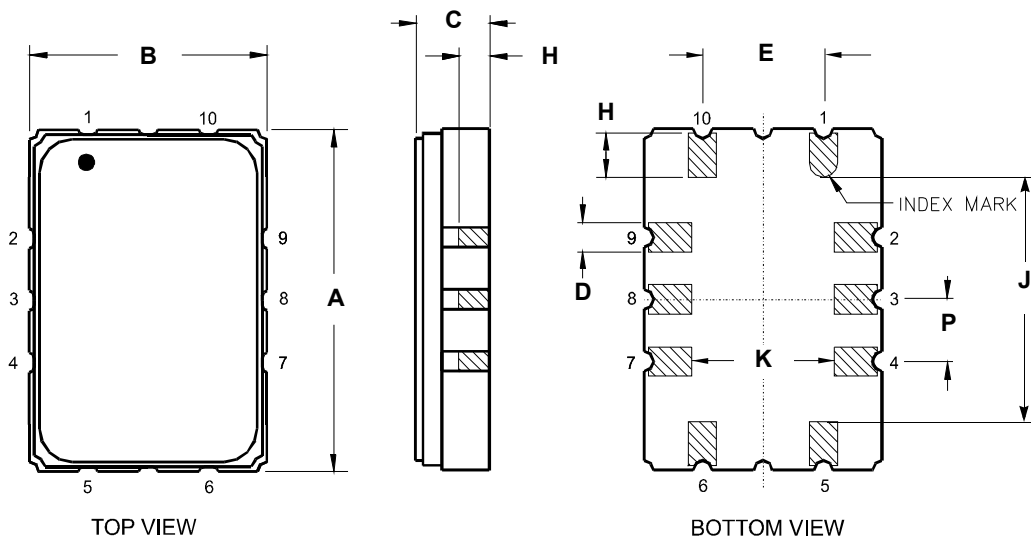

Tape and Reel Specifications

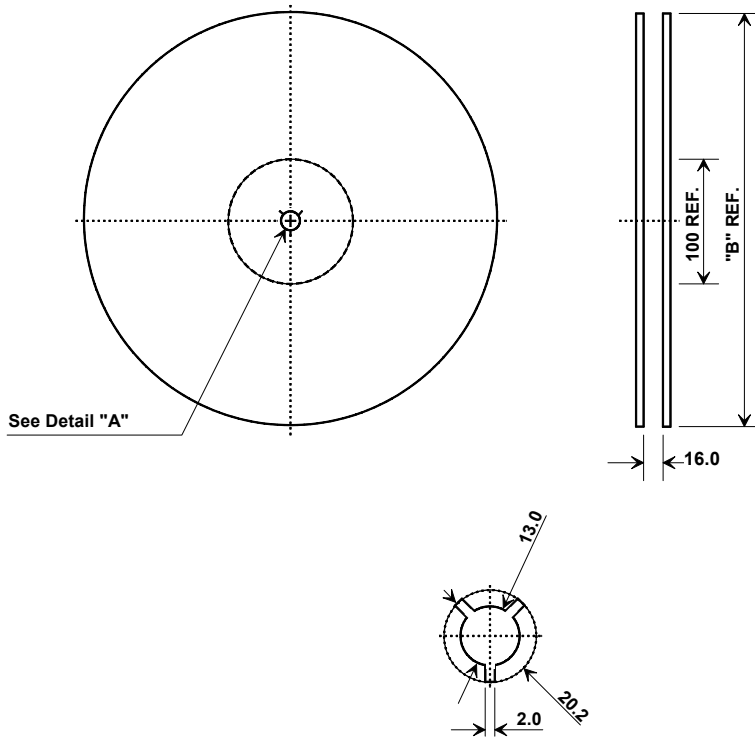

"B"		Quantity Per Reel
Inches	millimeters	
7	178	500
13	330	2000

COMPONENT ORIENTATION and DIMENSIONS

Carrier Tape Dimensions	
Ao	5.5 mm
Bo	7.5 mm
Ko	2.0 mm
Pitch	8.0 mm
W	16.0 mm

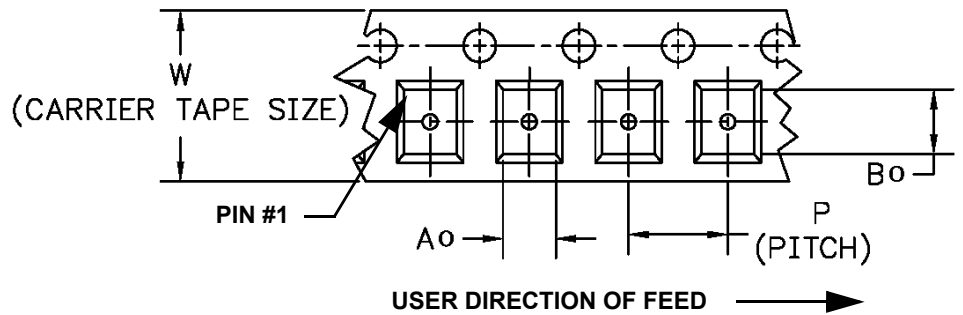
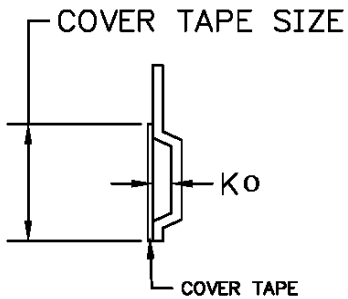

单击下面可查看定价，库存，交付和生命周期等信息

[>>Murata\(村田\)](#)