



佛山市国星光电股份有限公司
FOSHAN NATIONSTAR OPTOELECTRONICS CO., LTD

产品规格书

SPECIFICATION

| | | | |
|-----------------------|--|-------------------|-----------|
| 顾客名称 Customer | | 产品名称 Product | Chip LED |
| 顾客型号 Customer Type | | 产品型号 Type | NCD040201 |
| 顾客部品号 Customer No. | | 版本号 Version NO | A 版 |



地址: 广东省佛山市禅城区华宝南路18号
Add: NO.18 South Huabao Rd, Foshan, Guangdong, China
电话 (Tel): 0757-82100219
传真 (Fax): 0757-82100220
邮编 (Zip): 528000
邮箱 (Email): chipLED@nationstar.com
<http://www.nationstar.com>



| | | | |
|---------------------------------------|-------------|---------------|-------------------------------|
| 研发中心 Research & Development Center | | | 客户 (加盖公章) Customer (Stamp) |
| 制定 DRAW | 审核 CHECK | 批准 APPROVE | 确认 CONFIRM |
| | | | |
| 发放日期 (Release Date): 2019-10-30 | | | |

保存期限: 长期

NCD040201

Chip Light Emitting Diode

技术数据表 Technical Data Sheet

本产品主要作为信号指示及照明的电子元件广泛应用于各类使用表面贴装结构的电子产品中,如家用电器的开关指示灯、手机键盘灯、汽车仪表盘指示灯等。

This product is generally used as indicator and luminance for surface mounted electronic equipment, such as household appliance, communication equipment, and dashboard.

特性:

管芯材料: AlGaInP
Material:

发光颜色: 橙色
Emitting Color: Orange

Features:

- 封装材料: 环氧树脂
Encapsulation: Epoxy Resin
- 焊接方法: 无铅回流焊
Soldering methods: Pb-Free reflow soldering
- 光强高, 功耗低, 可靠性好, 寿命长
High Luminous Intensity, Low Power Dissipation, Good Reliability and Long Lifespan
- 符合欧盟公布的 ROHS 指令要求
Complied With ROHS Directive

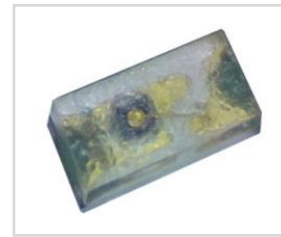

* 产品规格如因工艺改进而有所改变, 恕不另行通知。
* The specifications of the product may be modified for improvement without notice.

外形尺寸

Outline Dimension

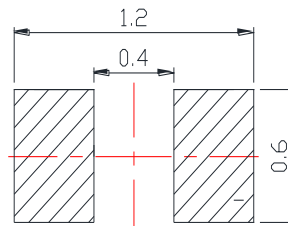
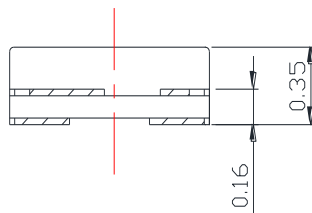
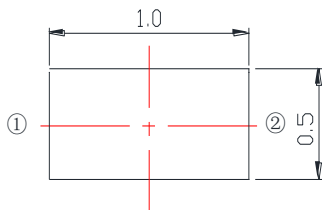

推荐焊盘尺寸
Recommended Soldering Pad

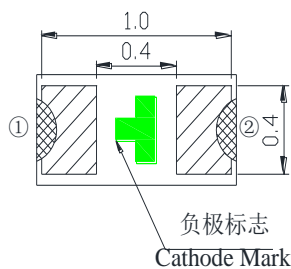

敷铜区域:
Cuprum Area:

阻焊丝印区域:
Solder Resist:

*无特别规定时, 公差: ±0.1mm
* The Tolerances Unless Mentioned is : ±0.1mm

光电参数 (1)

Electro-Optical Characteristics(1)

◇ 极限参数 (温度=25℃)
Absolute Maximum Ratings (Temperature=25 °C)

| 参数名称 Parameter | 符号 Symbol | 数值 Rating | 单位 Unit |
|-----------------------------------|--------------|--------------|------------|
| 正向电流 Forward Current | I_F | 25 | mA |
| 正向脉冲电流* Pulse Forward Current* | I_{FP} | 50 | mA |
| 反向电压 Reverse Voltage | V_R | 5 | V |
| 工作温度 Operating Temperature | T_{OPR} | -30 ~ +85 | °C |
| 贮存温度 Storage Temperature | T_{stg} | -40 ~ +100 | °C |
| 功耗 Power Dissipation | P_D | 65 | mW |

* 注: 脉冲宽度 $\leq 0.1ms$, 占空比 $\leq 1/10$ * Note: Pulse Width $\leq 0.1ms$, Duty $\leq 1/10$

◇ 光电参数 (温度=25℃)
Electro-Optical Characteristics (Temperature=25 °C)

| 参数名称 Parameter | 符号 Symbol | 条件 Condition | 最小值 Min. | 典型值 Typ. | 最大值 Max. | 单位 Unit |
|--------------------------------------|-----------------|-----------------|-------------|-------------|-------------|------------|
| 反向电流 Reverse Current | I_R | $V_R=5V$ | - | - | 10 | μA |
| 视角 View Angle | $2\theta_{1/2}$ | - | - | 130 | - | deg. |
| 正向电压 Forward Voltage | V_F | $I_F=5mA$ | 1.6 | 1.8 | 2.6 | V |
| 峰值波长 Peak Wavelength | λ_P | | | 610 | | nm |
| 主波长 Dominant Wavelength | λ_d | | 598 | 604 | 610 | nm |
| 半波宽度 Spectrum Radiation Bandwidth | $\Delta\lambda$ | | | 15 | | nm |
| 光强 Luminous Intensity | I_V | | 20 | 26 | 45 | mcd |

* 注 1: 光强偏差 $\pm 15\%$; 压降偏差 $\pm 0.1V$; (X,Y)坐标偏差 ± 0.01 ; 单色光波长偏差 $\pm 1nm$ 。

* Note1: Tolerance on each Luminous Intensity bin is $\pm 15\%$; Tolerance on each Forward Voltage bin is $\pm 0.1V$; Tolerance on each Hue(X,Y) bin is ± 0.01 ; Tolerance of Dominant Wavelength $\pm 1nm$.

* 注 2: 以上参数仅供参考, 请以实物标签为准。我司给出的参数均由国星测试系统测得。

* Note2: The parameters above are only for your reference. In case of any discrepancy, please adhere to the label of our actual products. All parameters are tested by the standard testing system of NationStar.

光电参数 (2)

Electro-Optical Characteristics(2)

◇ 正向电压 (温度=25℃, 测试电流=5 mA)

Forward Voltage (Ta=25 °C,IF=5mA)

| 典型电压档范围 Voltage Classification Range | |
|---|-----------|
| V _F | 1.6-1.8 V |
| | 1.8-2.0 V |
| | 2.0-2.2 V |
| | 2.2-2.4 V |

◇ 光强 (温度=25℃, 测试电流=5 mA)

Luminous Intensity (Ta=25 °C,IF=5mA)

| 典型光强档范围 Luminous Classification Range | |
|--|-----------|
| I _v | 20-24 mcd |
| | 24-30 mcd |
| | 30-36 mcd |
| | 36-45 mcd |

◇ 主波长 (温度=25℃, 测试电流=5 mA)

Dominant Wavelength (Ta=25 °C,IF=5mA)

| 典型波长档范围 Dominant Wavelength Range | |
|--------------------------------------|------------|
| λ _d | 598-601 nm |
| | 601-604 nm |
| | 604-607 nm |
| | 607-610 nm |

典型特性曲线

Typical Characteristics Curves

伏安特性
Volt-Ampere Characteristics

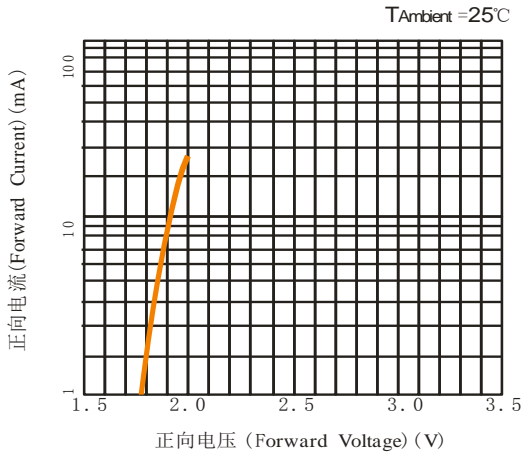

相对光强与正向电流特性
Relative Luminous Intensity VS Forward Current

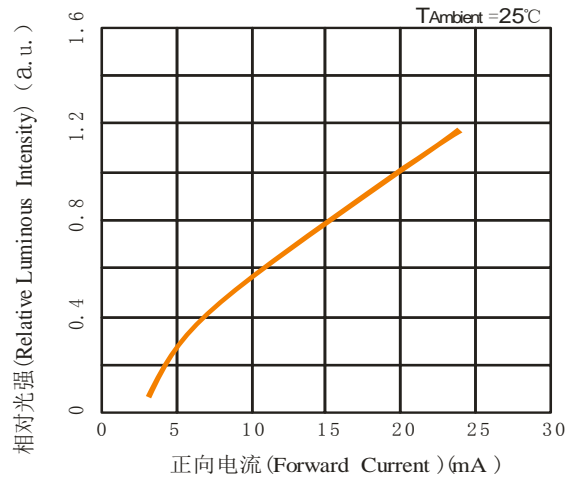

正向电流降额曲线
Forward Current Derating Curve

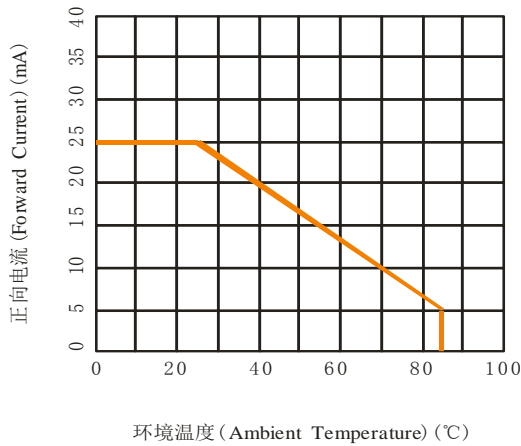

光强与环境温度曲线
Luminous Intensity VS Ambient Temperature

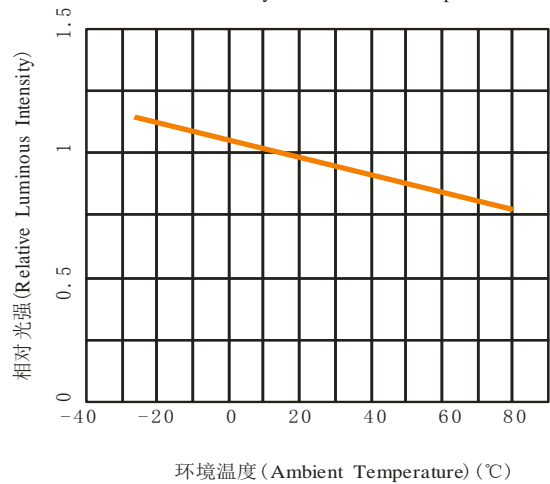

光谱分布特性曲线
Relative Spectral Distribution

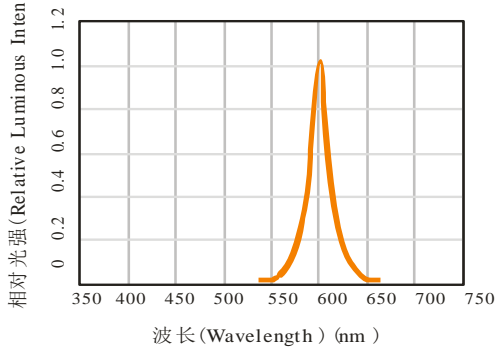

光强分布特性曲线
Typical Spatial Distribution

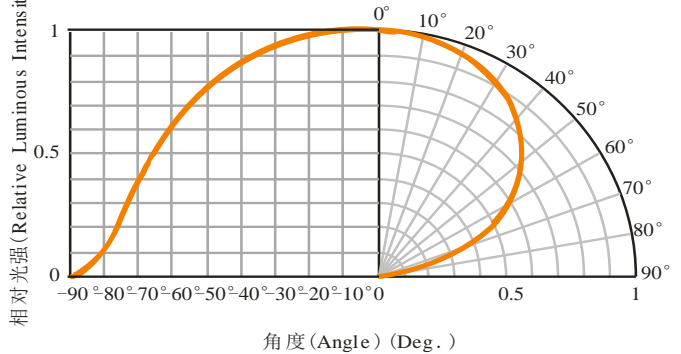

可靠性试验

Reliability Test Items And Conditions

| 实验项目 Test Items | 参考标准 Reference | 实验条件 Test Conditions | 时间 Time | 样品数 Quantity | 判据 Criterion |
|--|---------------------------|---|------------------------|-----------------|-----------------|
| 冷热冲击 Thermal Shock | MIL-STD-202G | -40°C(15min)←→100°C(15min) | 循环 200 次 200 cycles | 22 | 0/22 |
| 湿热循环 Temperature And Humidity Cyclic | JEITA ED-4701 200 203 | (-10~65)°C , (0~90)%RH 24hrs./1cycle | 循环 10 次 10 cycles | 22 | 0/22 |
| 高温贮存 High Temperature Storage | JEITA ED-4701 200 201 | Ta=100°C | 1000h | 22 | 0/22 |
| 低温贮存 Low Temperature Storage | JEITA ED-4701 200 202 | Ta=-40°C | 1000h | 22 | 0/22 |
| 常温寿命试验 Lifespan Test | JESD22-A108D | Ta=25°C IF=10mA | 1000h | 22 | 0/22 |
| 耐焊接热 Resistance to Soldering Heat | GB/T 4937, II ,2.2&2.3 | Tsol*=260°C 10secs. | 2 次 2 times | 22 | 0/22 |

失效判断标准 Criteria For Judging Damage

| 测试项目 Test Items | 符号 Symbol | 测试条件 Test Conditions | 判定标准 Criteria For Judging Damage |
|--------------------------------------|----------------|----------------------------------|---|
| 正向电压 Forward Voltage | V _F | I _F = I _{FT} | 初始值±10% Initial Data±10% |
| 反向电流 Reverse Current | I _R | V _R = 5V | I _R ≤10μA |
| 光强 Luminous Intensity | I _V | I _F = I _{FT} | I _V 衰减≤50% IV degradation≤50% |
| 耐焊接热 Resistance to Soldering Heat | | | 无死灯 No dead light |

* 注: T_{sol}-锡液温度; I_{FT}: 典型电流

* Note: T_{sol}-Temperature of tin liquid; I_{FT}: Typical current.

包装 (1)

Packaging (1)

◇ 载带 Carrier Tape

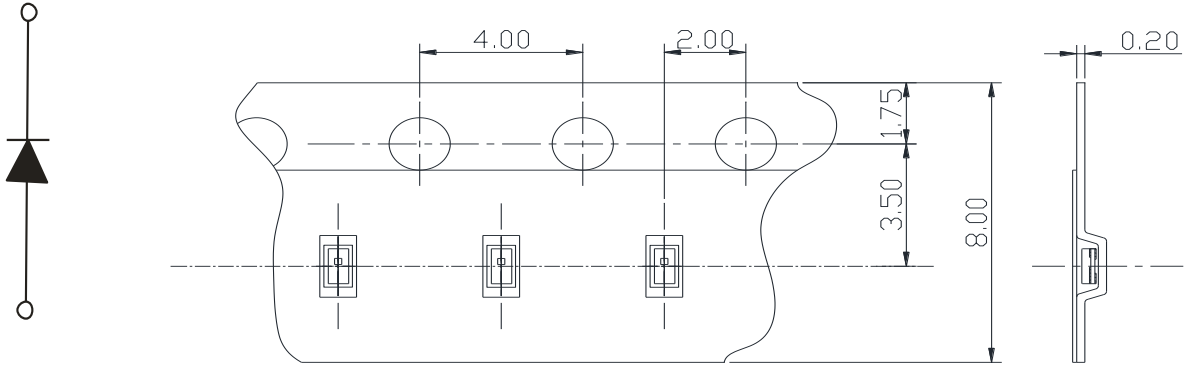

单位: mm, 未注公差: ±0.1 mm
All dimensions in mm, tolerances unless mentioned is ±0.1 mm.

◇ 编带细节 Details Of Carrier Tape

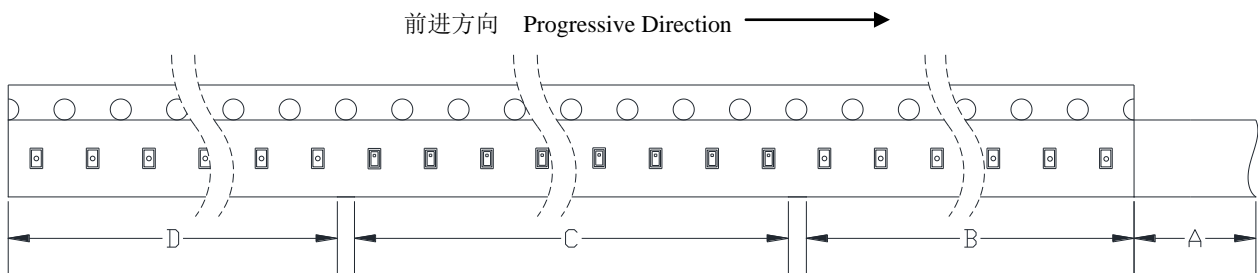

A: 盖带, 200 mm; B: 引导, 空带, 100mm; C: 编载产品 6000 只; D: 尾部, 空带, 100mm
A: Top Cover Tape, 200mm; B: Leader, Empty, 100mm; C: 6000 Lamps Loaded; D: Trailer, Empty, 100mm.

◇ 带盘 Reel Dimension

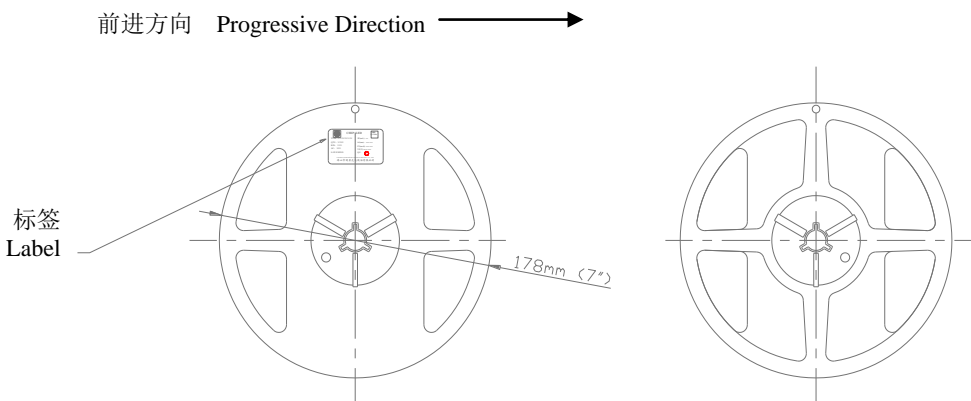

包装 (2)

Packaging (2)

防潮抗静电包装 Moisture Proof and Anti-Electrostatic Foil Bag



外包装箱 Cardboard Box

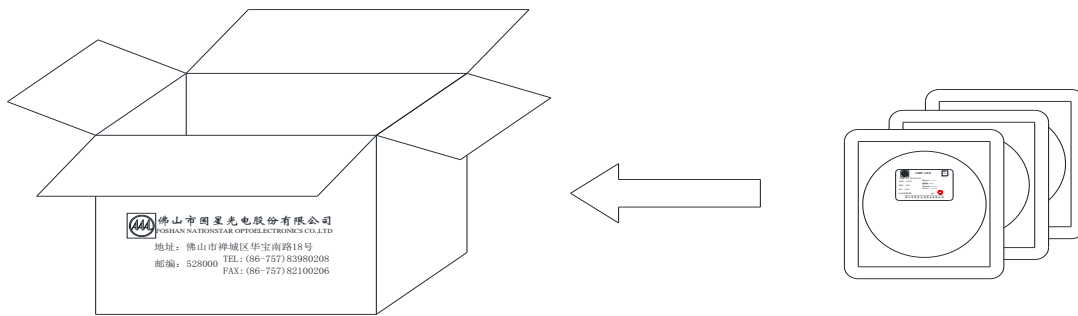

标签说明 Label Explanation

TYPE: 产品型号

QTY: 数量 Quantity

BIN: 分档 Rank

SC: 分档编号 Step Code

LOT: 批号 Lot Number

λd : 波长范围 Wavelength Range

IV: 光强范围 Luminous Intensity Range

VF: 正向电压范围 Forward Voltage Range

IF: 测试电流 Testing Current

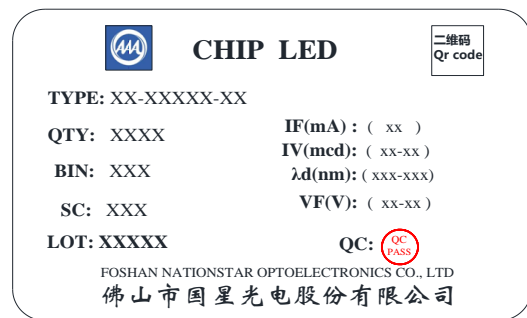

单击下面可查看定价，库存，交付和生命周期等信息

[>>NATIONSTAR\(国星光电\)](#)