

## 650V 75A Trench FS Gen.7 IGBT

### General Description

Using NCE's proprietary high density trench gate design and advanced FS (Field Stop) Gen.7 technology, the 650V Trench FS Gen.7 IGBT offers superior conduction and switching performances, and easy parallel operation.

### Features

- Trench field stop Gen.7 Technology Offering
- Low saturation voltage:  $V_{CEsat} = 1.45V(Typ.) @ I_C = 75 A$
- High speed switching, low switching losses
- Maximum junction temperature  $T_{vjmax} = 175^{\circ}C$
- Tighten parameter distribution
- High ruggedness, temperature stable behavior
- Pb-free lead plating; RoHS compliant

### Application

- PV power
- Three-level Solar String Inverter
- UPS

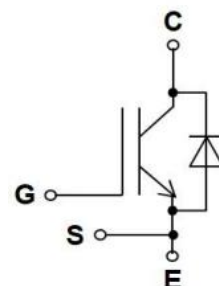

Schematic diagram

### Package Marking and Ordering Information

Device	Device Package	Device Marking
NCE75ED65VT4	TO-247-4L	NCE75ED65VT4



TO-247-4L

### Absolute Maximum Ratings ( $T_C=25^{\circ}C$ unless otherwise noted)

Symbol	Parameter	Value	Units
$V_{CES}$	Collector-Emitter Voltage	650	V
$V_{GES}$	Gate- Emitter Voltage	$\pm 30$	V
$I_C$	Collector Current	150	A
	Collector Current @ $T_C = 100^{\circ}C$	75	A
$I_{Cpuls}$	Pulsed Collector Current, $t_p$ limited by $T_{jmax}$	262	A
-	Turn off safe operating area, $V_{CE}=650V, T_j=175^{\circ}C$	262	A
$I_F$	Diode Continuous Forward Current @ $T_C = 100^{\circ}C$	75	A
$I_{FM}$	Diode Maximum Forward Current	262	A
$P_D$	Power Dissipation @ $T_C = 25^{\circ}C$	402	W
	Power Dissipation @ $T_C = 100^{\circ}C$	201	W
$T_{stg}$	Storage Temperature	-55 to +150	$^{\circ}C$
$T_{vj}$	Operating junction temperature	-40 to +175	$^{\circ}C$
$T_L$	Maximum Temperature for Soldering	260	$^{\circ}C$

## Thermal Characteristic

Symbol	Parameter	Value	Units
$R_{\theta JC}$	Thermal Resistance, Junction to case for IGBT	0.38	$^{\circ}\text{C}/\text{W}$
$R_{\theta JC}$	Thermal Resistance, Junction to case for Diode	0.43	$^{\circ}\text{C}/\text{W}$
$R_{\theta JA}$	Thermal Resistance, Junction to Ambient	40	$^{\circ}\text{C}/\text{W}$

## Electrical Characteristics ( $T_C=25^{\circ}\text{C}$ unless otherwise noted)

Symbol	Parameter	Conditions	Value			Units	
			Min.	Typ.	Max.		
<b>Static Characteristics</b>							
$V_{(BR)CES}$	Collector-Emitter Breakdown Voltage	$V_{GE}=0\text{V}, I_{CE}=1\text{mA}$	650	--	--	V	
$I_{CES}$	Collector-Emitter Leakage Current	$V_{GE}=0\text{V}, V_{CE}=650\text{V}$	--	--	15	$\mu\text{A}$	
$I_{GES(F)}$	Gate to Emitter Forward Leakage	$V_{GE}=+30\text{V}, V_{CE}=0\text{V}$	--	--	100	nA	
$I_{GES(R)}$	Gate to Emitter Reverse Leakage	$V_{GE}=-30\text{V}, V_{CE}=0\text{V}$	--	--	100	nA	
$V_{CE(sat)}$	Collector-Emitter Saturation Voltage	$I_C=40\text{A}$ $V_{GE}=15\text{V}$	$T_J=25^{\circ}\text{C}$	--	1.15	--	V
			$T_J=175^{\circ}\text{C}$	--	1.25	--	V
		$I_C=75\text{A}$ $V_{GE}=15\text{V}$	$T_J=25^{\circ}\text{C}$	--	1.45	1.90	V
			$T_J=175^{\circ}\text{C}$	--	1.75	--	V
$V_{GE(th)}$	Gate Threshold Voltage	$I_C=1\text{mA}, V_{CE}=V_{GE}$	4.0	4.75	5.5	V	
<b>Dynamic Characteristics</b>							
$C_{ies}$	Input Capacitance	$V_{CE}=25\text{V}, V_{GE}=0\text{V},$ $f=1\text{MHz}$	4020	4730	5440	pF	
$C_{oes}$	Output Capacitance		--	157	--		
$C_{res}$	Reverse Transfer Capacitance		--	29	--		
$Q_g$	Total Gate Charge	$V_{CC}=480\text{V}, I_C=75\text{A},$ $V_{GE}=15\text{V}$	--	155	--	nC	
$Q_{ge}$	Gate to Emitter Charge		--	40	--		
$Q_{gc}$	Gate to Collector Charge		--	37	--		
$R_g$	Internal Gate Resistance	$f=1\text{MHz}$	--	0.5	--	$\Omega$	
<b>Switching Characteristics</b>							
$t_{d(ON)}$	Turn-on Delay Time	$V_{CC}=400\text{V}, I_C=75\text{A},$ $V_{GE}=0/15\text{V}, R_g=6.2\Omega,$ Inductive Load	--	50	--	ns	
$t_r$	Rise Time		--	20	--		
$t_{d(OFF)}$	Turn-Off Delay Time		--	200	--		
$t_f$	Fall Time		--	31	--		
$E_{on}$	Turn-On Switching Loss		Inductive Load	--	2.0	--	mJ
$E_{off}$	Turn-Off Switching Loss			--	0.9	--	
$E_{ts}$	Total Switching Loss			--	2.9	--	
$E_{on}$	Turn-On Switching Loss			$V_{CC}=400\text{V}, I_C=75\text{A},$ $V_{GE}=0/15\text{V}, R_g=6.2\Omega,$ Inductive Load, $T_J=175^{\circ}\text{C}$	--	2.7	
$E_{off}$	Turn-Off Switching Loss	--	1.4		--		
$E_{ts}$	Total Switching Loss	--	4.1		--		

**Electrical Characteristics of the Diode (T<sub>c</sub>= 25°C unless otherwise specified)**

Symbol	Parameter	Conditions		Rating			Units
				Min.	Typ.	Max.	
V <sub>FM</sub>	Diode Forward Voltage	I <sub>F</sub> =75A	T <sub>J</sub> =25°C	--	1.7	2.4	V
			T <sub>J</sub> =175°C	--	1.5	--	V
T <sub>rr</sub>	Reverse Recovery Time	I <sub>F</sub> =75A, R <sub>g</sub> =6.2Ω		--	120	--	ns
I <sub>RRM</sub>	Diode Peak Reverse Recovery Current			--	33	--	A
Q <sub>rr</sub>	Reverse Recovery Charge			--	2.11	--	uC
E <sub>rec</sub>	Reverse recovery energy			--	0.24	--	mJ
T <sub>rr</sub>	Reverse Recovery Time	I <sub>F</sub> =75A,R <sub>g</sub> =6.2Ω, T <sub>J</sub> =175°C		--	180	--	ns
I <sub>RRM</sub>	Diode Peak Reverse Recovery Current			--	49	--	A
Q <sub>rr</sub>	Reverse Recovery Charge			--	4.49	--	uC
E <sub>rec</sub>	Reverse recovery energy			--	0.36	--	mJ

Note: For optimum lifetime and reliability, NCE recommends operating conditions that do not exceed 80% of the maximum ratings stated in this datasheet.

## Test Circuit

### 1) Gate Charge Test Circuit

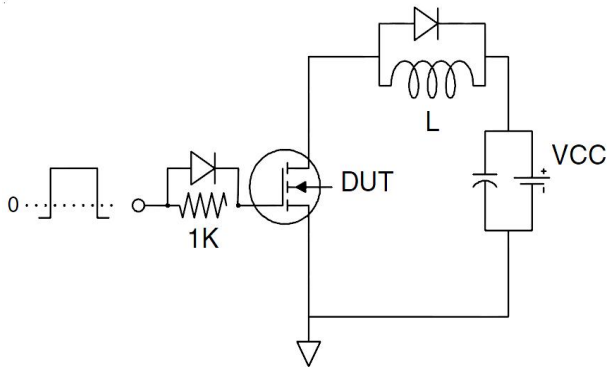

### 2) Switch Time Test Circuit

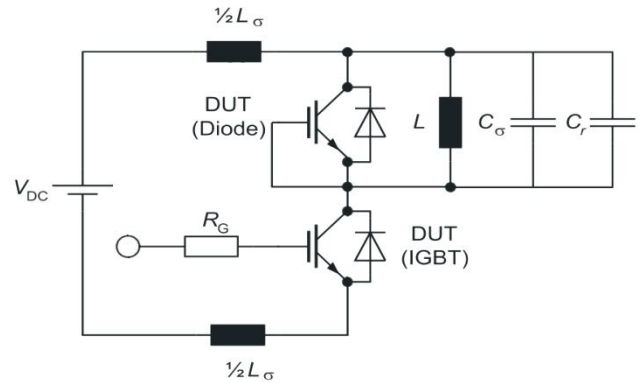

## Switching characteristics

### 1) Definition of switching times

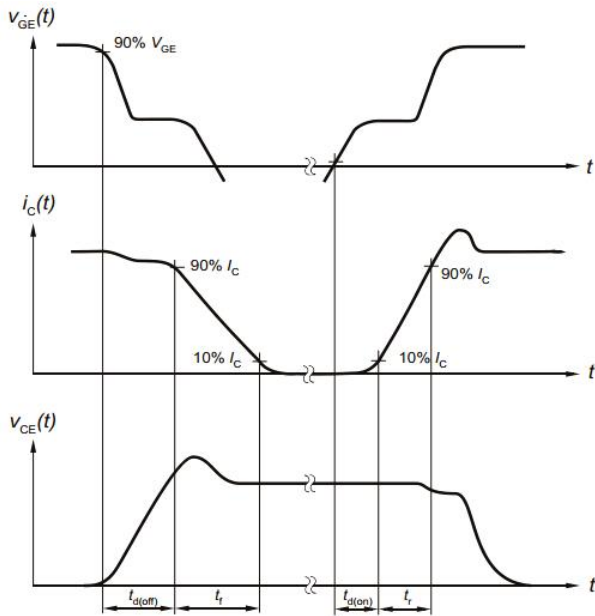

### 2) Definition of switching losses

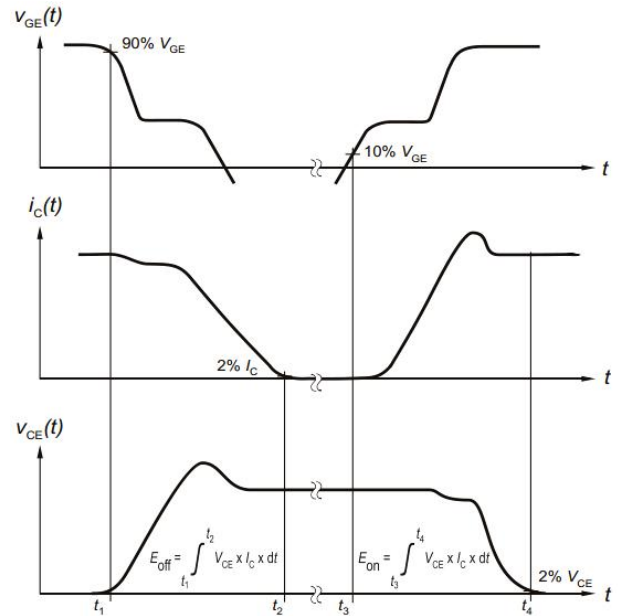

### 3) Definition of diode switching characteristics

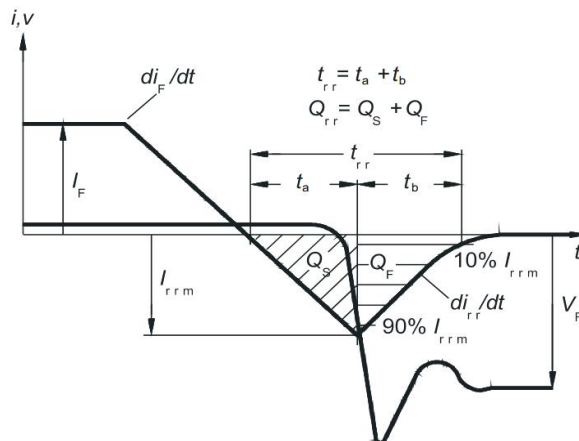

Typical Electrical and Thermal Characteristics

Figure 1 Output Characteristics

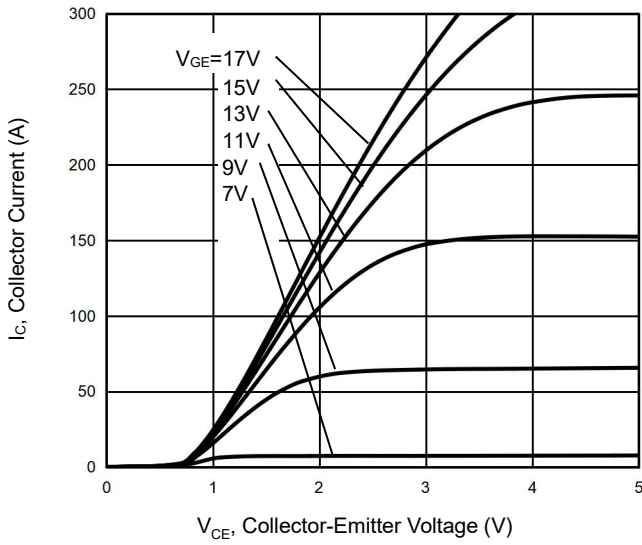

Figure 2 Transfer Characteristics

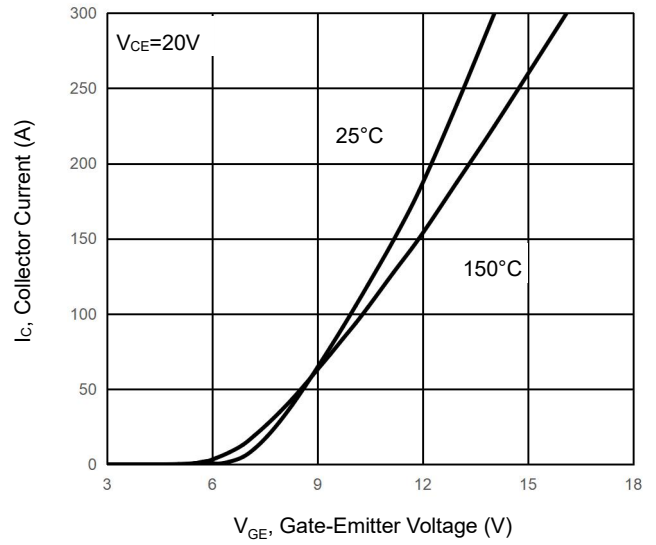

Figure 3  $V_{CE(sat)}$  vs. Temperature

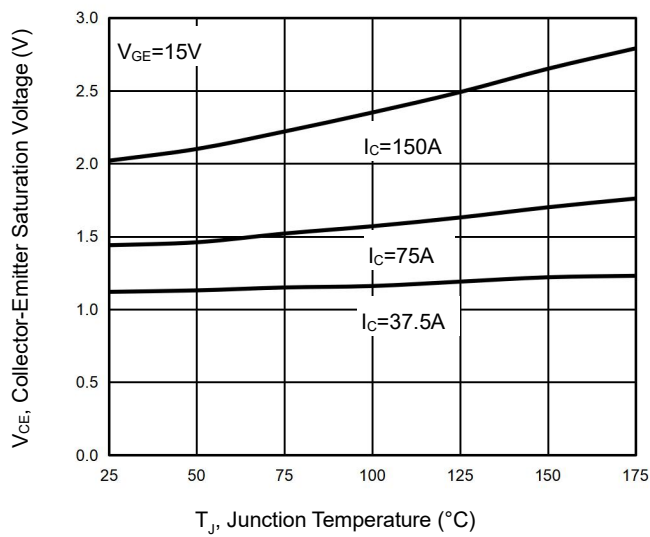

Figure 4 Saturation Voltage vs.  $V_{GE}$

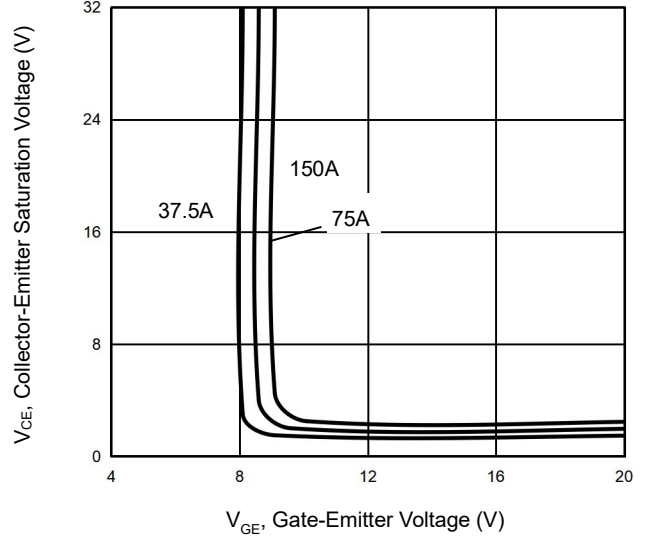

Figure 5 Capacitance Characteristics

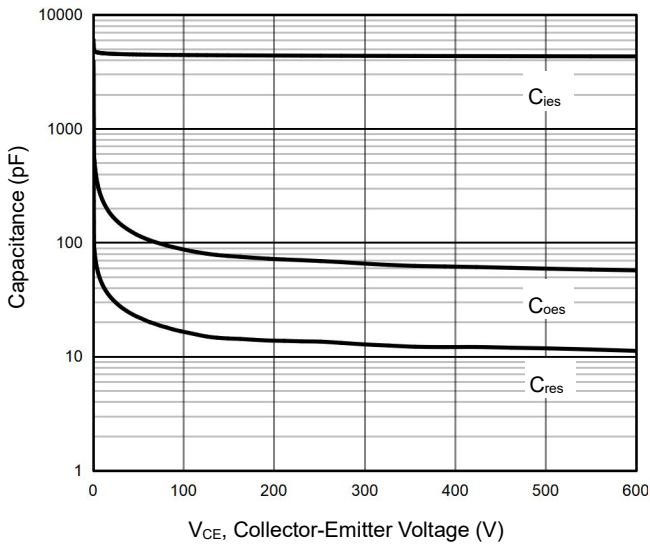
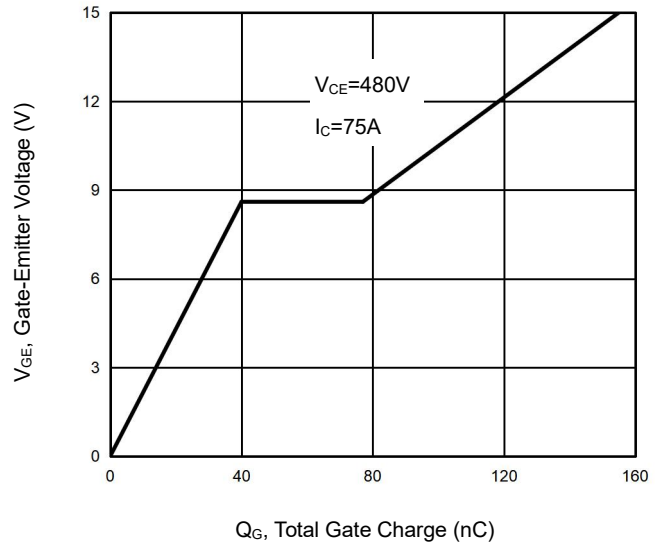
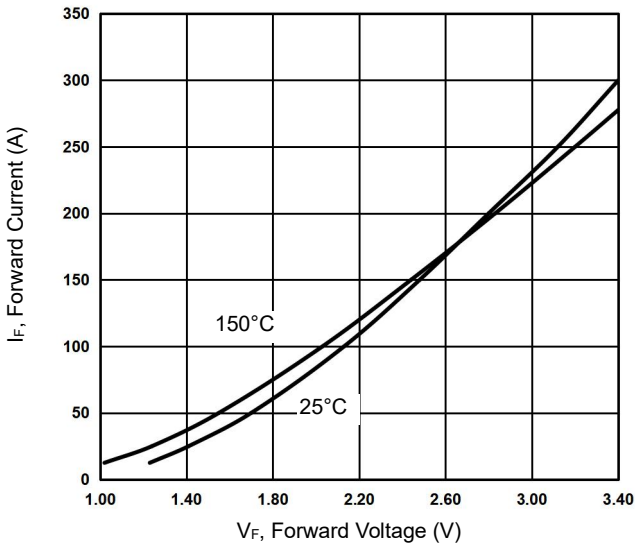

Figure 6 Gate Charge Wave Form



## Typical Electrical and Thermal Characteristics

**Figure 7 Forward Characteristics**



**Figure 8  $V_F$  vs. Temperature**

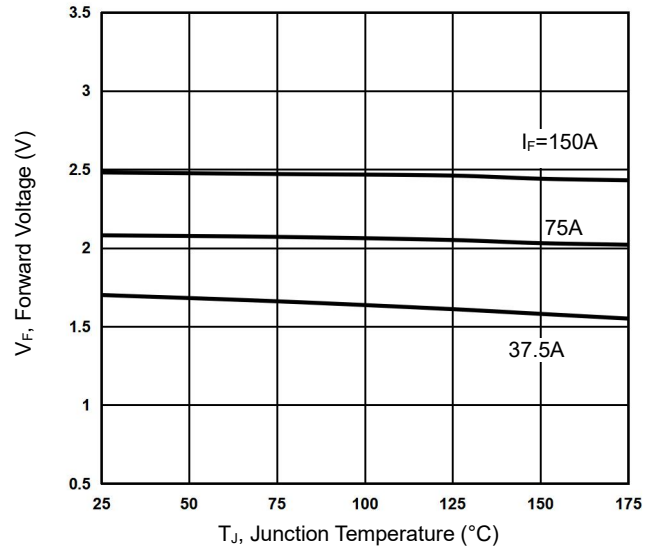

**Figure 9 Switching Loss vs.  $R_G$**

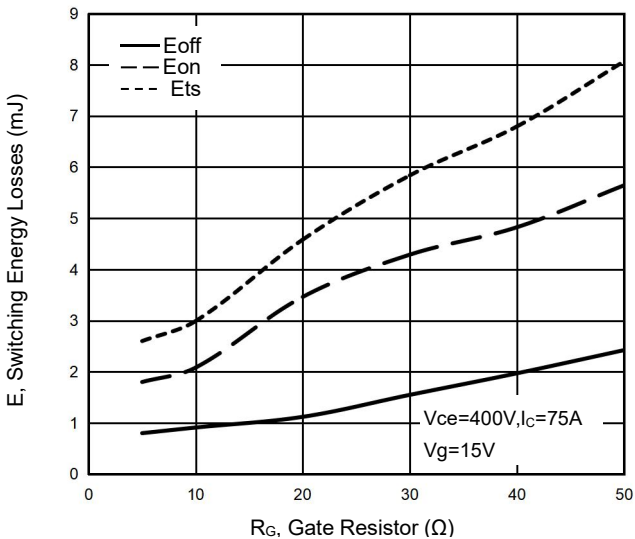

**Figure 10 Switching Loss vs. Collector Current**

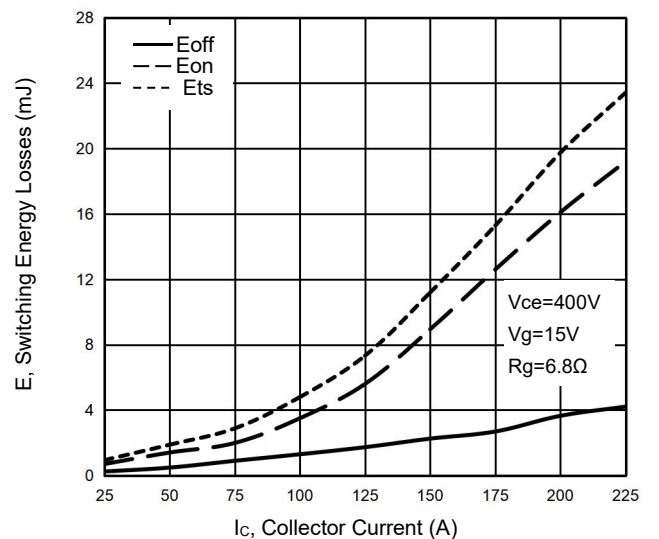

**Figure 11 Gate-Emitter Threshold Voltage as a Function of Junction Temperature(Normalized)**

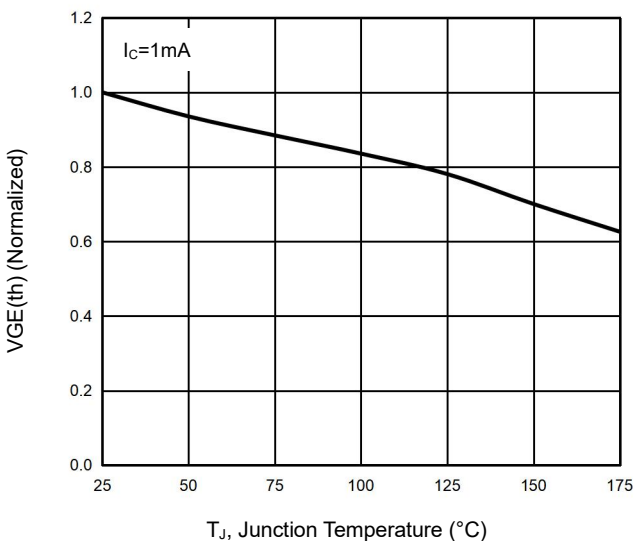

**Figure 12  $P_{tot}$  vs. Case Temperature**

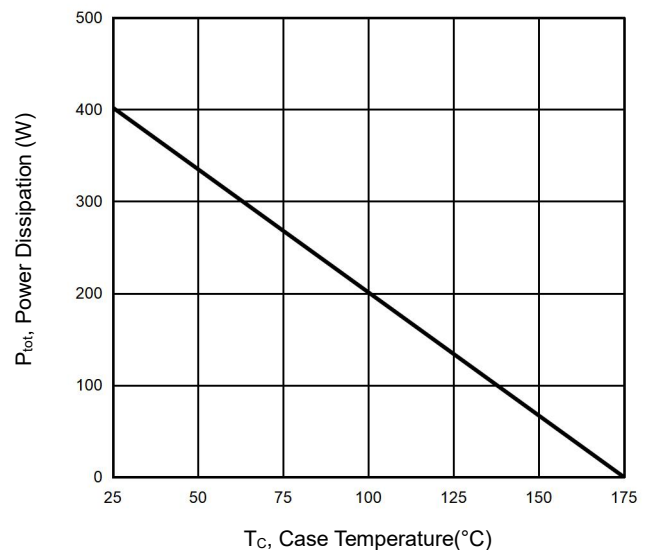

Typical Electrical and Thermal Characteristics

Figure 13 Switching Loss vs. Temperature

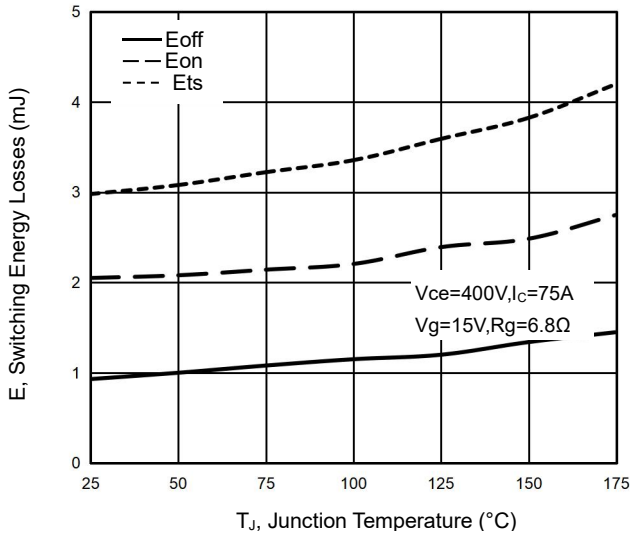

Figure 14 Switching Loss vs. V<sub>CE</sub>

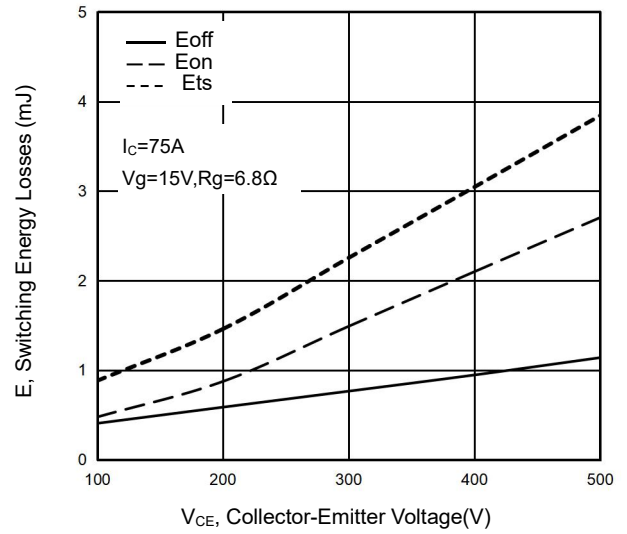

Figure 15 Gate-Emitter Threshold Voltage as a Function of Junction Temperature(Normalized)

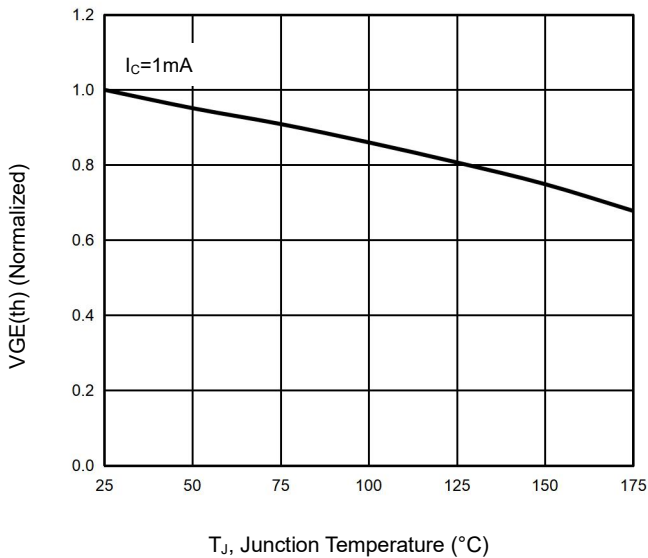

Figure 16 Typical Collector-Emitter Saturation Voltage as a Function of Collector Current(Normalized)

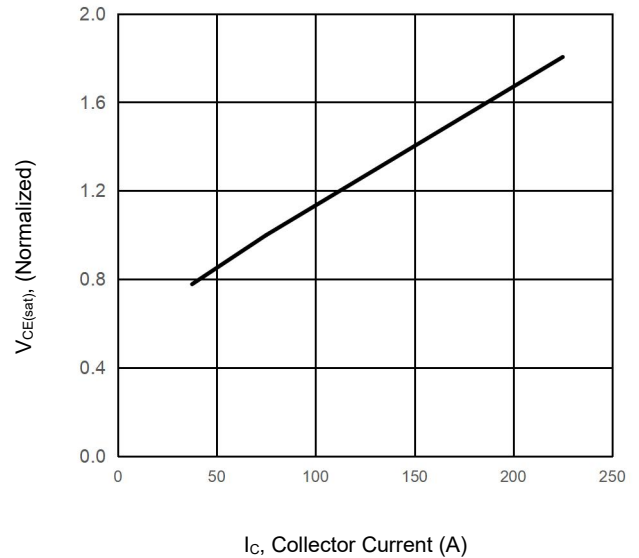

Figure 17 V<sub>(BR)CES</sub> vs. Temperature

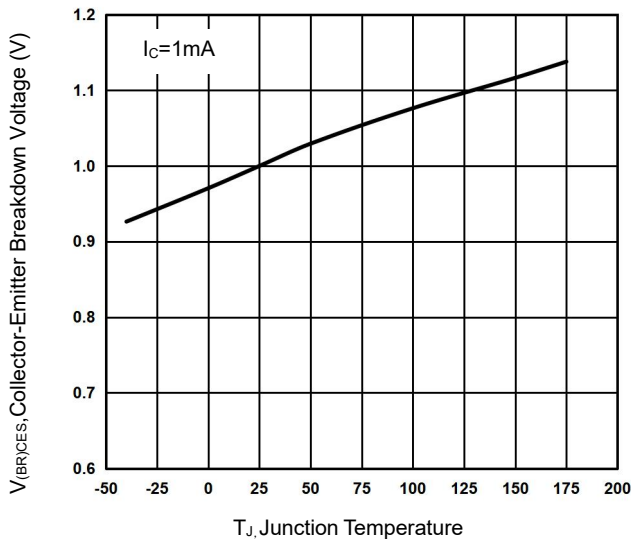
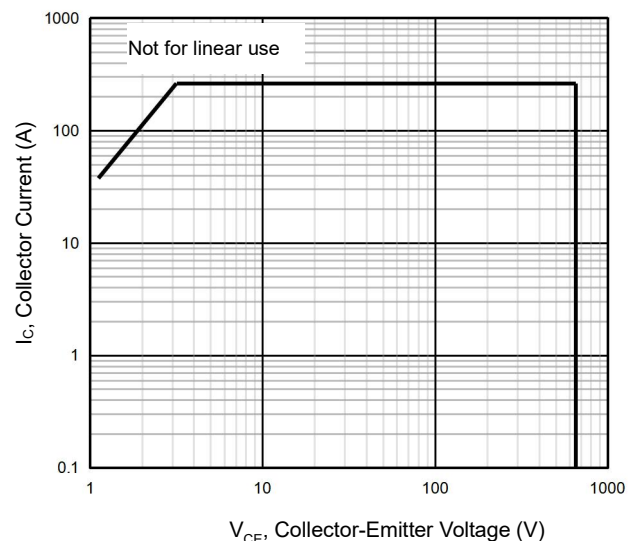
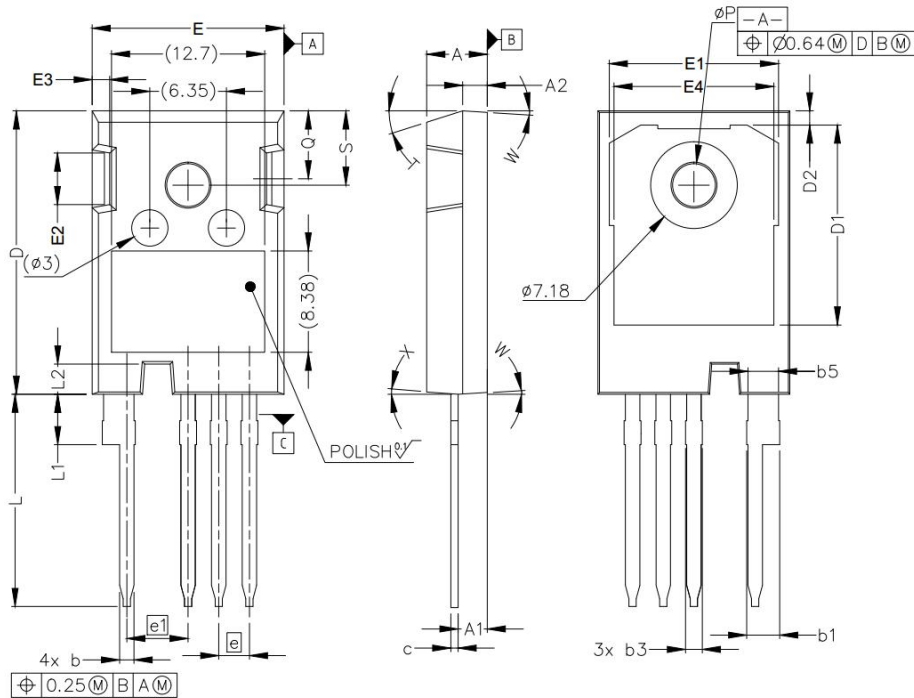

Figure 18 Forward Bias Safe Operating Area



# TO-247-4L(B) Package Information



Symbol	Dimensions In Millimeters		Dimensions In Inches	
	Min.	Max.	Min.	Max.
A	4.83	5.21	0.19	0.21
A1	2.29	2.54	0.09	0.10
A2	1.91	2.16	0.08	0.09
b	1.07	1.33	0.04	0.05
b1	2.39	2.94	0.09	0.12
b3	1.07	1.60	0.04	0.06
b5	2.39	2.69	0.09	0.11
c	0.55	0.68	0.02	0.03
D	23.30	23.60	0.92	0.93
D1	16.25	17.65	0.64	0.69
D2	0.95	1.25	0.04	0.05
E	15.75	16.13	0.62	0.64
E1	13.10	14.15	0.52	0.56
E2	3.68	5.10	0.14	0.20
E3	1.00	1.90	0.04	0.07
E4	12.38	13.43	0.49	0.53
e	2.54 BSC		0.1 BSC	
e1	5.08 BSC		0.2 BSC	
L	17.31	17.82	0.68	0.70
L1	3.97	4.37	0.16	0.17
L2	2.35	2.65	0.09	0.10
$\phi P$	3.51	3.65	0.14	0.14
Q	5.49	6.00	0.22	0.24
S	6.04	6.30	0.24	0.25
T	17.5° REF.			
W	3.5° REF.			
X	4.0° REF.			



**Attention:**

- Any and all NCE power products described or contained herein do not have specifications that can handle applications that require extremely high levels of reliability, such as life-support systems, aircraft's control systems, or other applications whose failure can be reasonably expected to result in serious physical and/or material damage. Consult with your NCE power representative nearest you before using any NCE power products described or contained herein in such applications.
- NCE power assumes no responsibility for equipment failures that result from using products at values that exceed, even momentarily, rated values (such as maximum ratings, operating condition ranges, or other parameters) listed in products specifications of any and all NCE power products described or contained herein.
- Specifications of any and all NCE power products described or contained herein stipulate the performance, characteristics, and functions of the described products in the independent state, and are not guarantees of the performance, characteristics, and functions of the described products as mounted in the customer's products or equipment. To verify symptoms and states that cannot be evaluated in an independent device, the customer should always evaluate and test devices mounted in the customer's products or equipment.
- NCE power Semiconductor CO.,LTD. strives to supply high-quality high-reliability products. However, any and all semiconductor products fail with some probability. It is possible that these probabilistic failures could give rise to accidents or events that could endanger human lives, that could give rise to smoke or fire, or that could cause damage to other property. When designing equipment, adopt safety measures so that these kinds of accidents or events cannot occur. Such measures include but are not limited to protective circuits and error prevention circuits for safe design, redundant design, and structural design.
- In the event that any or all NCE power products(including technical data, services) described or contained herein are controlled under any of applicable local export control laws and regulations, such products must not be exported without obtaining the export license from the authorities concerned in accordance with the above law.
- No part of this publication may be reproduced or transmitted in any form or by any means, electronic or mechanical, including photocopying and recording, or any information storage or retrieval system, or otherwise, without the prior written permission of NCE power Semiconductor CO.,LTD.
- Information (including circuit diagrams and circuit parameters) herein is for example only ; it is not guaranteed for volume production. NCE power believes information herein is accurate and reliable, but no guarantees are made or implied regarding its use or any infringements of intellectual property rights or other rights of third parties.
- Any and all information described or contained herein are subject to change without notice due to product/technology improvement, etc. When designing equipment, refer to the "Delivery Specification" for the NCE power product that you intend to use.
- This catalog provides information as of Sep.2010. Specifications and information herein are subject to change without notice.

单击下面可查看定价，库存，交付和生命周期等信息

[>>NCEPOWER\(无锡新洁能\)](#)