

**600V, 15A, Trench FS II Fast IGBT**
**General Description:**

Using NCE's proprietary trench design and advanced FS (Field Stop) second generation technology, the 600V Trench FSII IGBT offers superior conduction and switching performances, and easy parallel operation;

**Features**

- Trench FSII Technology offering
- Very low  $V_{CE(sat)}$
- High speed switching
- Positive temperature coefficient in  $V_{CE(sat)}$
- Very tight parameter distribution
- High ruggedness, temperature stable behavior

**Application**

- Air Condition
- Inverters
- Motor drives

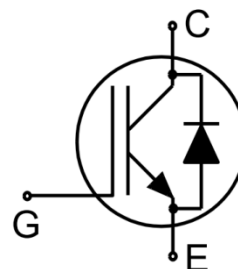
**Schematic diagram**
**Package Marking and Ordering Information**

Device	Device Package	Device Marking
NCE15TD60BF	TO-220F	NCE15TD60BF

**TO-220F**
**Absolute Maximum Ratings ( $T_C=25^{\circ}\text{C}$  unless otherwise noted)**

Symbol	Parameter	Value	Units
$V_{CES}$	Collector-Emitter Voltage	600	V
$V_{GES}$	Gate- Emitter Voltage	$\pm 30$	V
$I_C$	Collector Current	30	A
	Collector Current @ $T_C = 100^{\circ}\text{C}$	15	A
$I_{Cplus}$	Pulsed Collector Current, $t_p$ limited by $T_{jmax}$	45	A
-	turn off safe operating area, $V_{CE}=600\text{V}$ , $T_j=150^{\circ}\text{C}$	45	A
$I_F$	Diode Continuous Forward Current @ $T_C = 100^{\circ}\text{C}$	15	A
$I_{FM}$	Diode Maximum Forward Current	45	A
$P_D$	Power Dissipation @ $T_C = 25^{\circ}\text{C}$	34	W
	Power Dissipation @ $T_C = 100^{\circ}\text{C}$	17	W
$T_J, T_{stg}$	Operating Junction and Storage Temperature Range	-55 to +175	$^{\circ}\text{C}$
$T_L$	Maximum Temperature for Soldering	260	$^{\circ}\text{C}$
$t_{sc}$	Short circuit withstand time $V_{GE}=15.0\text{V}$ , $V_{CC}\leq 400\text{V}$ , Allowed number of short circuits<1000Time between short circuits: $\geq 1.0\text{s}$ , $T_j\leq 150^{\circ}\text{C}$	5	us

**Thermal Characteristic**

Symbol	Parameter	Value	Units
R <sub>θJC</sub>	Thermal Resistance, Junction to case for IGBT	4.41	°C/W
R <sub>θJC</sub>	Thermal Resistance, Junction to case for Diode	3.97	°C/W
R <sub>θJA</sub>	Thermal Resistance, Junction to Ambient	78	°C/W

**Electrical Characteristics (T<sub>c</sub>=25°C unless otherwise noted)**

Symbol	Parameter	Test Conditions	Rating			Units
			Min.	Typ.	Max.	
<b>Static Characteristics</b>						
V <sub>(BR)CES</sub>	Collector-Emitter Breakdown Voltage	V <sub>GE</sub> =0V, I <sub>CE</sub> =1mA	600	--	--	V
I <sub>CES</sub>	Collector-Emitter Leakage Current	V <sub>GE</sub> =0V, V <sub>CE</sub> =600V	--	--	4	μA
I <sub>GES(F)</sub>	Gate to Emitter Forward Leakage	V <sub>GE</sub> =+30V, V <sub>CE</sub> =0V	--	--	100	nA
I <sub>GES(R)</sub>	Gate to Source Reverse Leakage	V <sub>GE</sub> =-30V, V <sub>CE</sub> =0V	--	--	100	nA
V <sub>CE(sat)</sub>	Collector-Emitter Saturation Voltage	I <sub>C</sub> =15A, T <sub>J</sub> =25°C	--	1.7	1.9	V
		V <sub>GE</sub> =15V, T <sub>J</sub> =100°C	--	1.9	--	V
V <sub>GE(th)</sub>	Gate Threshold Voltage	I <sub>C</sub> =1mA, V <sub>CE</sub> =V <sub>GE</sub>	4.0	--	6.0	V
<b>Dynamic Characteristics</b>						
C <sub>ies</sub>	Input Capacitance	V <sub>CE</sub> =25V, V <sub>GE</sub> =0V, f=1MHz	--	1635	--	pF
C <sub>oes</sub>	Output Capacitance		--	50	--	
C <sub>res</sub>	Reverse Transfer Capacitance		--	30	--	
Q <sub>g</sub>	Total Gate Charge	V <sub>CC</sub> =480V, I <sub>C</sub> =15A V <sub>GE</sub> =15V	--	63	--	nC
Q <sub>ge</sub>	Gate to Emitter Charge		--	15	--	
Q <sub>gc</sub>	Gate to Collector Charge		--	26	--	
I <sub>C(SC)</sub>	Short circuit collector current Max.1000 short circuits Time between short circuits: ≥1.0s	V <sub>GE</sub> =15V, V <sub>CC</sub> ≤400V, t <sub>sc</sub> ≤5us, T <sub>J</sub> ≤150°C	--	82	--	A
<b>Switching Characteristics</b>						
t <sub>d(ON)</sub>	Turn-on Delay Time	V <sub>CC</sub> =400V, I <sub>C</sub> =10A V <sub>GE</sub> =0/15V, R <sub>g</sub> =5Ω Inductive Load	--	16	--	ns
t <sub>r</sub>	Rise Time		--	12	--	
t <sub>d(OFF)</sub>	Turn-Off Delay Time		--	124	--	
t <sub>f</sub>	Fall Time		--	12	--	
E <sub>on</sub>	Turn-On Switching Loss		--	0.25	--	mJ
E <sub>off</sub>	Turn-Off Switching Loss		--	0.12	--	
E <sub>ts</sub>	Total Switching Loss		--	0.37	--	

**Electrical Characteristics of the Diode(T<sub>c</sub>= 25°C unless otherwise specified):**

Symbol	Parameter	Test Conditions	Rating			Units
			Min.	Typ.	Max.	
V <sub>FM</sub>	Diode Forward Voltage	I <sub>F</sub> =15A	--	1.5	1.7	V
T <sub>rr</sub>	Reverse Recovery Time	I <sub>F</sub> =15A, di/dt=200A/us	--	170	--	ns
I <sub>RRM</sub>	Diode Peak Reverse Recovery Current		--	6.5	--	A
Q <sub>rr</sub>	Reverse Recovery Charge		--	0.7	--	μC

Pulse width t<sub>tp</sub>≤380μs, δ≤2%

Test Circuit

1) Gate Charge Test Circuit

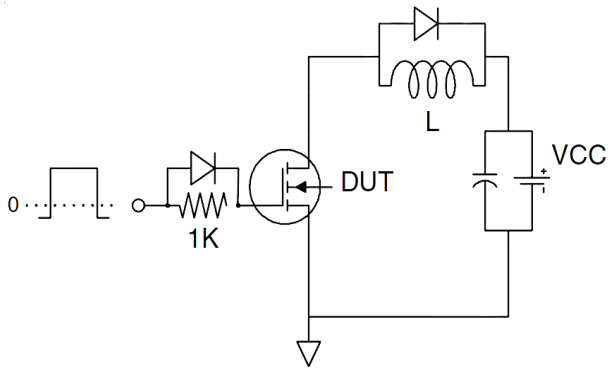

2) Switch Time Test Circuit

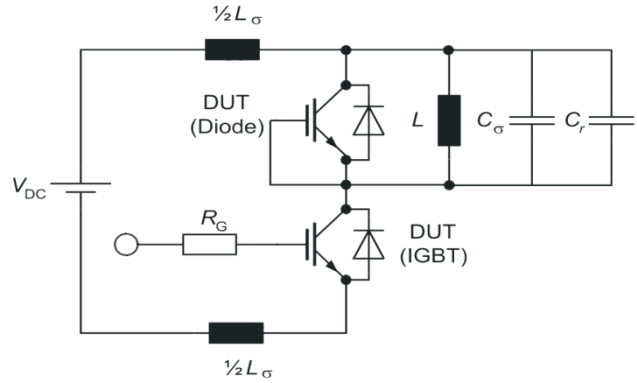

Switching characteristics

1) Definition of switching times

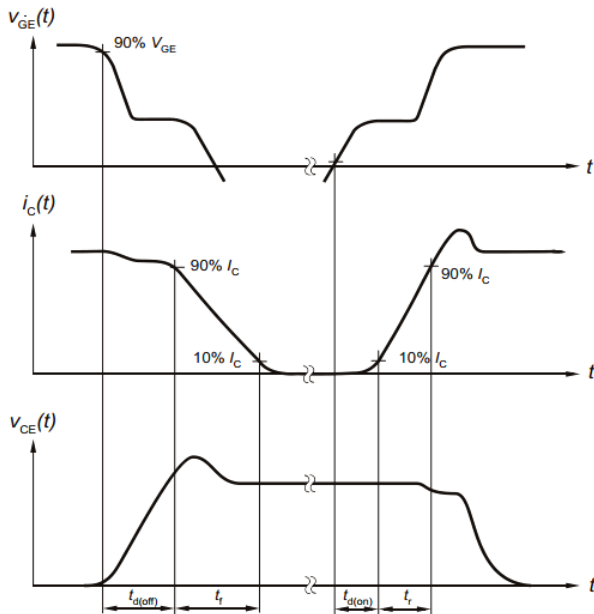

2) Definition of switching losses

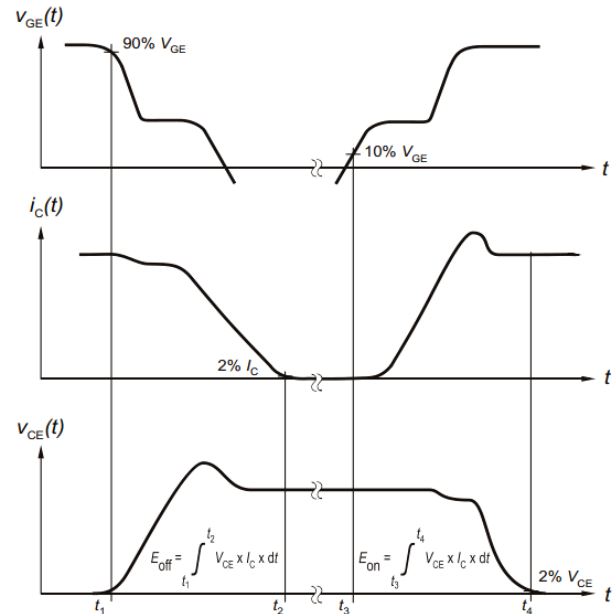

3) Definition of diode switching characteristics

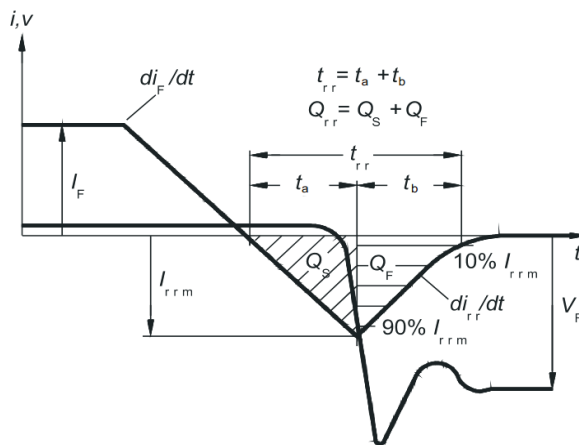

Typical Electrical and Thermal Characteristics

Figure 1 Output Characteristics

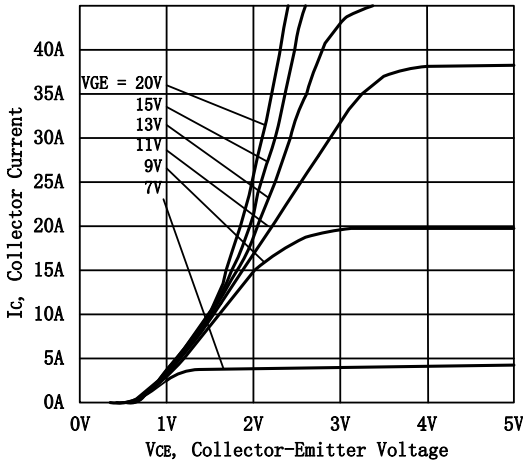

Figure 2 Transfer Characteristics

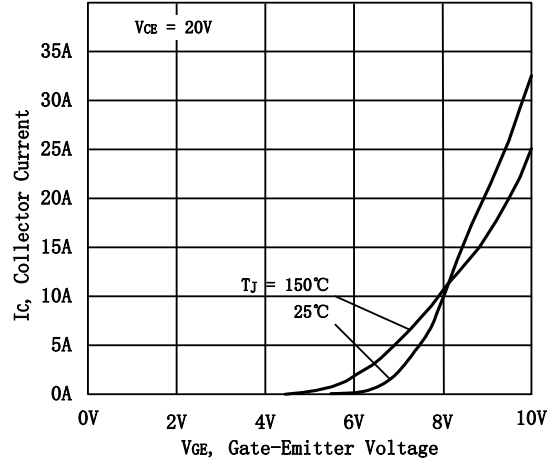

Figure 3 VCEsat vs. Case Temperature

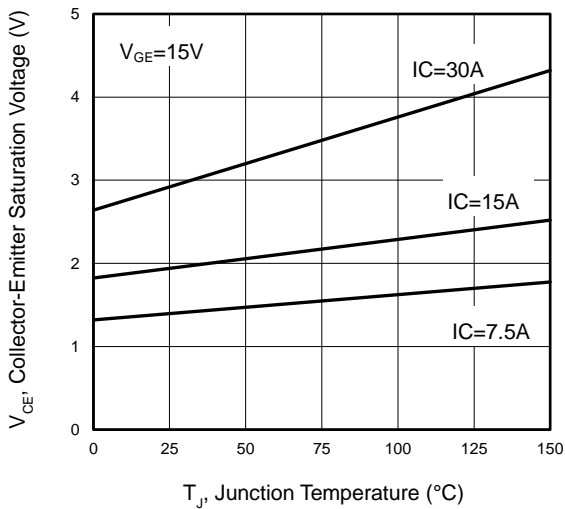

Figure 4 Saturation Voltage vs. VGE

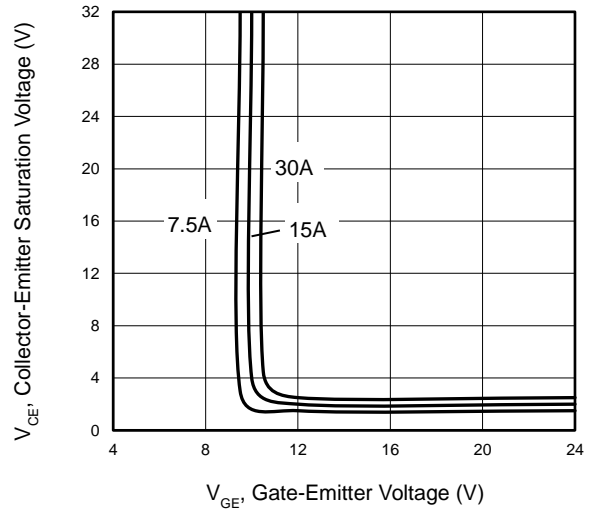

Figure 5 Capacitance Characteristics

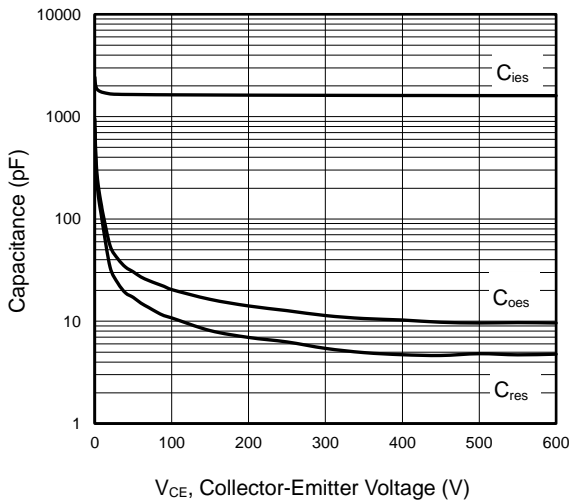
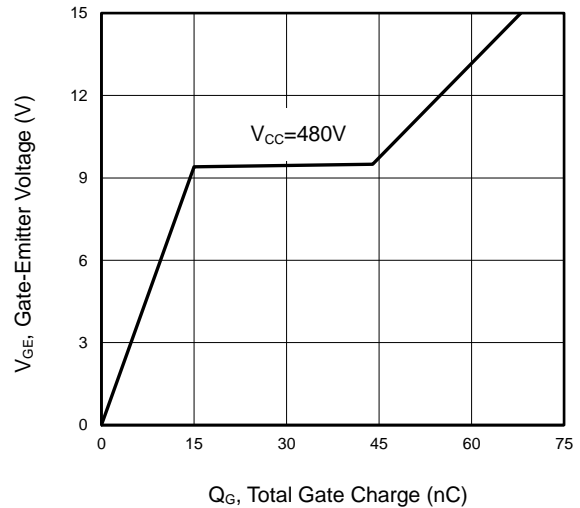

Figure 6 Gate charge waveform



Typical Electrical and Thermal Characteristics

Figure 7 Gate-emitter Threshold Voltage as a Function of Junction Temperature

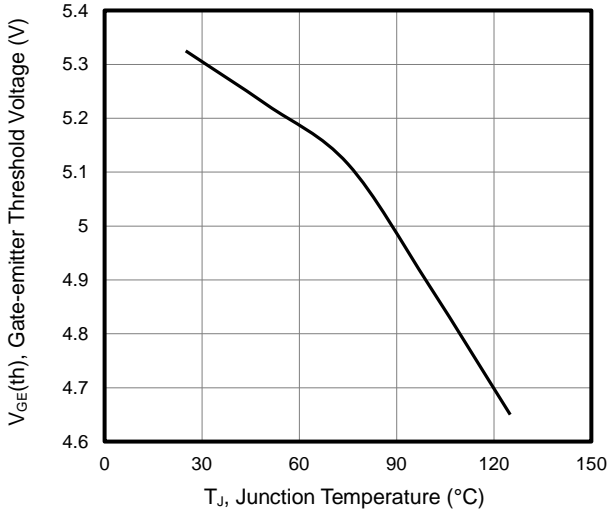

Figure 8 Typical Switching Times as a Function of Gate Resistor

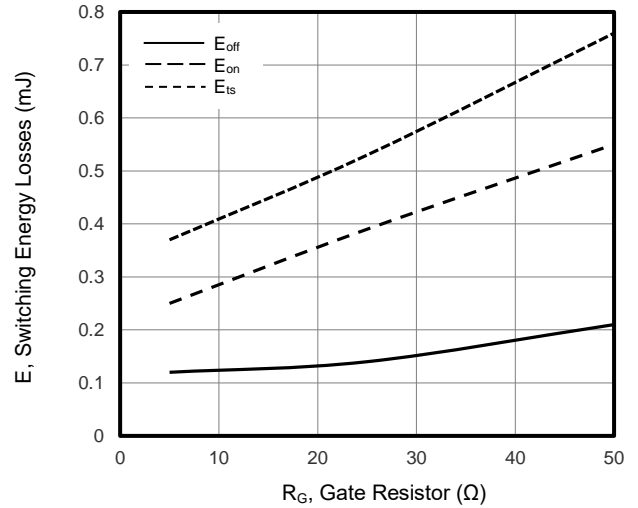

Figure 9 Typical Switching Times as a Function of Junction Temperature

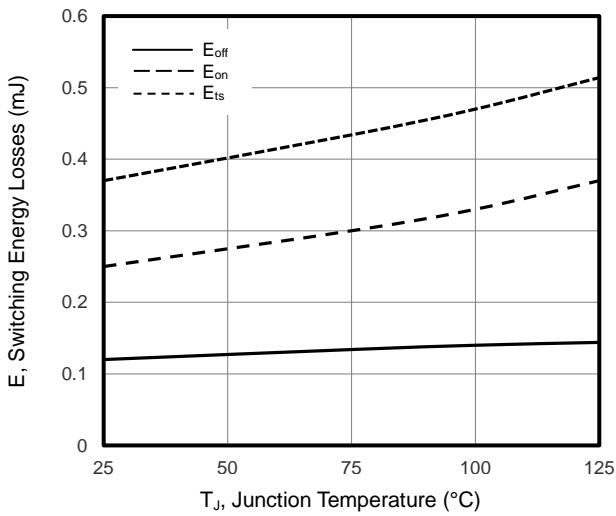

Figure 10 Power Dissipation as a Function of Case Temperature

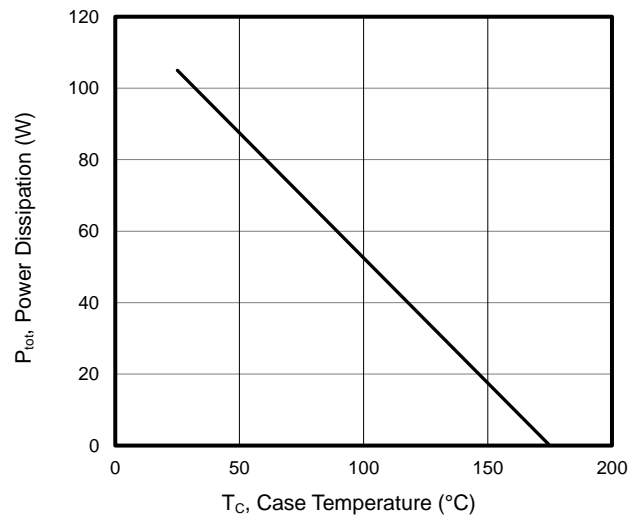

Figure 11 Reverse Bias SOA

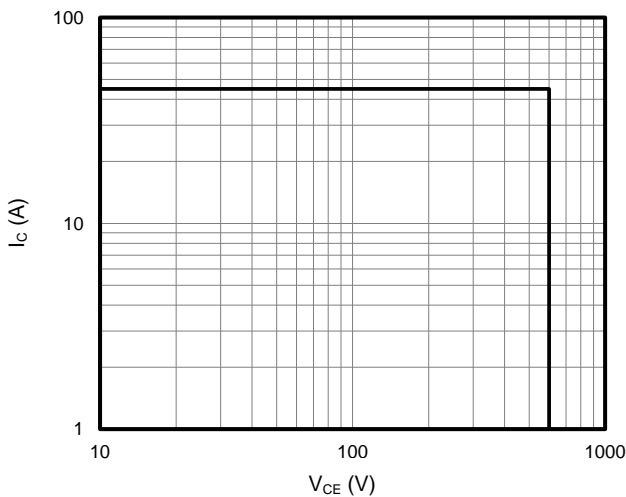
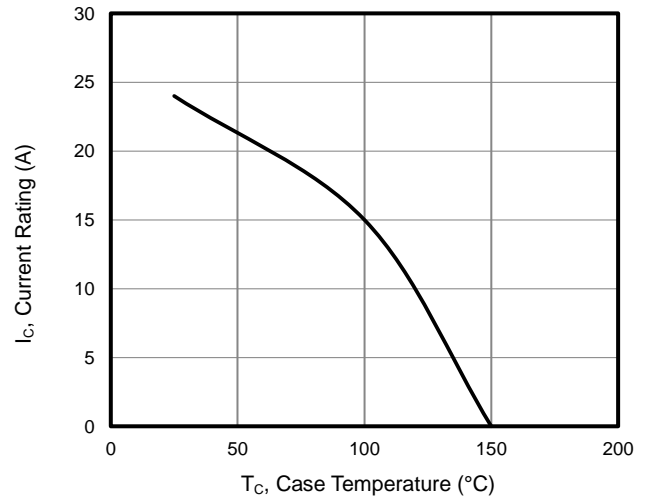

Figure 12 Current De-rating



Typical Electrical and Thermal Characteristics (continued)

Figure 13 Forward Characteristics

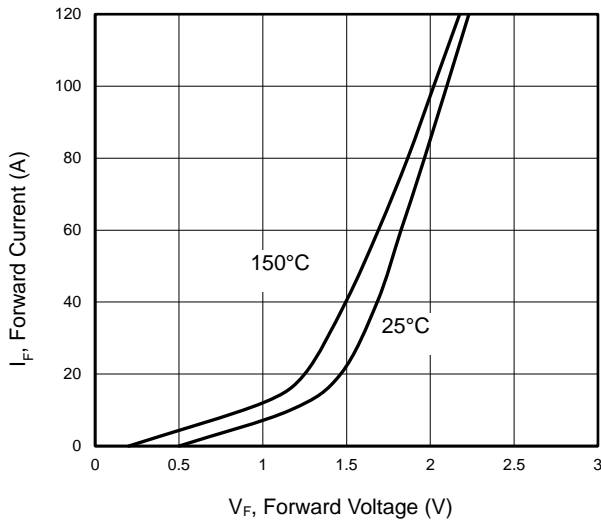
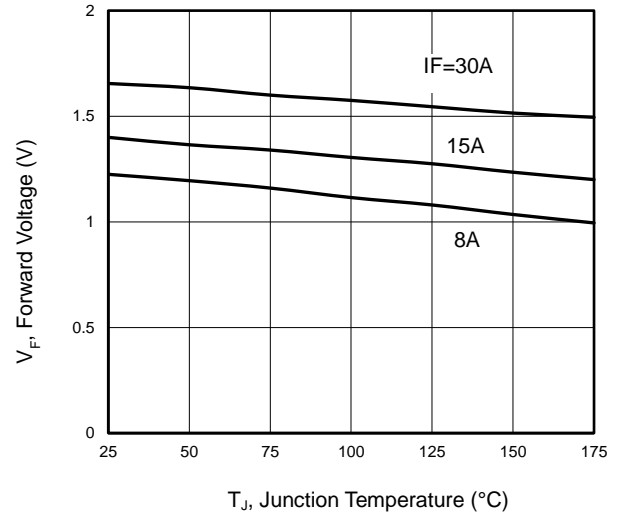
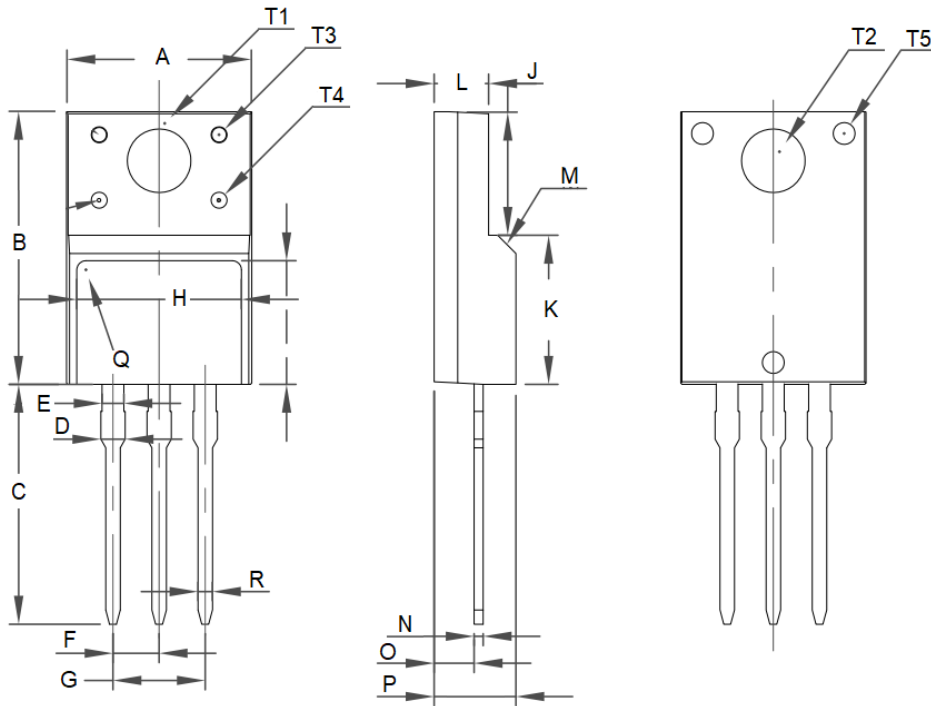

Figure 14  $V_F$  vs. temperature



# TO-220F Package Information



Symbol	Dimensions In Millimeters		Dimensions In Inches	
	Min.	Max.	Min.	Max.
A	9.96	10.36	0.39	0.41
B	15.67	16.07	0.62	0.63
C	13.14	13.54	0.52	0.53
D	1.20	1.40	0.05	0.06
E	1.20 BSC		0.05 BSC	
F	2.54 BSC		0.10 BSC	
G	5.08 BSC		0.20 BSC	
H	7.60	8.00	0.30	0.31
I	7.10	7.50	0.28	0.30
J	6.48	6.88	0.26	0.27
K	8.99	9.39	0.35	0.37
L	2.34	2.74	0.09	0.11
M	45°		1.77 BSC	
N	0.49	0.52	0.02	0.02
O	2.15	2.55	0.08	0.10
P	4.50	4.90	0.18	0.19
Q	0.50		0.02 BSC	
R	0.77	0.83	0.03	0.03
S	4°	5°	0.16	0.20
T1	3.45 BSC		0.14 BSC	
T2	3.18 BSC		0.13 BSC	
T3	1.50 BSC		0.06 BSC	
T4	1.20 BSC		0.05 BSC	
T5	1.50 BSC		0.06 BSC	

## Attention:

- Any and all NCE power products described or contained herein do not have specifications that can handle applications that require extremely high levels of reliability, such as life-support systems, aircraft's control systems, or other applications whose failure can be reasonably expected to result in serious physical and/or material damage. Consult with your NCE power representative nearest you before using any NCE power products described or contained herein in such applications.
- NCE power assumes no responsibility for equipment failures that result from using products at values that exceed, even momentarily, rated values (such as maximum ratings, operating condition ranges, or other parameters) listed in products specifications of any and all NCE power products described or contained herein.
- Specifications of any and all NCE power products described or contained herein stipulate the performance, characteristics, and functions of the described products in the independent state, and are not guarantees of the performance, characteristics, and functions of the described products as mounted in the customer's products or equipment. To verify symptoms and states that cannot be evaluated in an independent device, the customer should always evaluate and test devices mounted in the customer's products or equipment.
- NCE power Semiconductor CO.,LTD. strives to supply high-quality high-reliability products. However, any and all semiconductor products fail with some probability. It is possible that these probabilistic failures could give rise to accidents or events that could endanger human lives, that could give rise to smoke or fire, or that could cause damage to other property. When designing equipment, adopt safety measures so that these kinds of accidents or events cannot occur. Such measures include but are not limited to protective circuits and error prevention circuits for safe design, redundant design, and structural design.
- In the event that any or all NCE power products(including technical data, services) described or contained herein are controlled under any of applicable local export control laws and regulations, such products must not be exported without obtaining the export license from the authorities concerned in accordance with the above law.
- No part of this publication may be reproduced or transmitted in any form or by any means, electronic or mechanical, including photocopying and recording, or any information storage or retrieval system, or otherwise, without the prior written permission of NCE power Semiconductor CO.,LTD.
- Information (including circuit diagrams and circuit parameters) herein is for example only ; it is not guaranteed for volume production. NCE power believes information herein is accurate and reliable, but no guarantees are made or implied regarding its use or any infringements of intellectual property rights or other rights of third parties.
- Any and all information described or contained herein are subject to change without notice due to product/technology improvement, etc. When designing equipment, refer to the "Delivery Specification" for the NCE power product that you intend to use.
- This catalog provides information as of Sep.2010. Specifications and information herein are subject to change without notice.



单击下面可查看定价，库存，交付和生命周期等信息

[>>NCEPOWER\(无锡新洁能\)](#)