



BUK7Y13-40B

N-channel TrenchMOS standard level FET

Rev. 03 — 26 May 2008

Product data sheet

1. Product profile

1.1 General description

Standard level N-channel enhancement mode Field-Effect Transistor (FET) in a plastic package using Nexperia High-Performance Automotive (HPA) TrenchMOS technology. This product has been designed and qualified to the appropriate AEC standard for use in automotive critical applications.

1.2 Features and benefits

- 175 °C rated
- Suitable for standard level gate drive sources
- Q101 compliant
- Suitable for thermally demanding environments due to 175 °C rating

1.3 Applications

- 12 V loads
- Automotive ABS systems
- Fuel pump and injection
- Air bag
- Automotive transmission control
- Motors, lamps and solenoids

1.4 Quick reference data

Table 1. Quick reference

Symbol	Parameter	Conditions	Min	Typ	Max	Unit
V_{DS}	drain-source voltage	$T_j \geq 25\text{ °C}; T_j \leq 175\text{ °C}$	-	-	40	V
I_D	drain current	$V_{GS} = 10\text{ V}; T_{mb} = 25\text{ °C};$ see Figure 1 and 4	-	-	58	A
P_{tot}	total power dissipation	$T_{mb} = 25\text{ °C};$ see Figure 2	-	-	85	W
Dynamic characteristics						
Q_{GD}	gate-drain charge	$I_D = 10\text{ A}; V_{DS} = 32\text{ V};$ $V_{GS} = 10\text{ V};$ see Figure 14	-	5	-	nC
Static characteristics						
$R_{DS(on)}$	drain-source on-state resistance	$V_{GS} = 10\text{ V}; I_D = 25\text{ A};$ $T_j = 25\text{ °C};$ see Figure 13 and 12	-	11	13	mΩ
Avalanche ruggedness						
$E_{DS(AL)S}$	non-repetitive drain-source avalanche energy	$I_D = 58\text{ A}; V_{sup} \leq 40\text{ V};$ $R_{GS} = 50\text{ } \Omega; V_{GS} = 10\text{ V};$ $T_{j(init)} = 25\text{ °C};$ unclamped	-	-	85	mJ

2. Pinning information

Table 2. Pinning

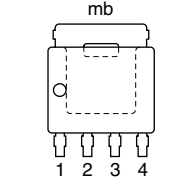
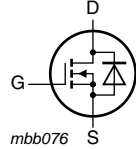
Pin	Symbol	Description	Simplified outline	Graphic symbol
1, 2, 3	S	source	 <p>SOT669 (LPAK)</p>	 <p>mbb076</p>
4	G	gate		
mb	D	mounting base; connected to drain		

3. Ordering information

Table 3. Ordering information

Type number	Package		Version
	Name	Description	
BUK7Y13-40B	LPAK	plastic single-ended surface-mounted package (LPAK); 4 leads	SOT669

4. Limiting values

Table 4. Limiting values

In accordance with the Absolute Maximum Rating System (IEC 60134).

Symbol	Parameter	Conditions	Min	Max	Unit
V_{DS}	drain-source voltage	$T_j \geq 25\text{ °C}$; $T_j \leq 175\text{ °C}$	-	40	V
V_{DGR}	drain-gate voltage	$R_{GS} = 20\text{ k}\Omega$	-	40	V
V_{GS}	gate-source voltage		20	20	V
I_D	drain current	$T_{mb} = 25\text{ °C}$; $V_{GS} = 10\text{ V}$; see Figure 1 and 4	-	58	A
		$T_{mb} = 175\text{ °C}$; $V_{GS} = 10\text{ V}$; see Figure 1	-	41	A
I_{DM}	peak drain current	$T_{mb} = 25\text{ °C}$; $t_p \leq 10\text{ }\mu\text{s}$; pulsed; see Figure 4	-	234	A
P_{tot}	total power dissipation	$T_{mb} = 25\text{ °C}$; see Figure 2	-	85	W
T_{stg}	storage temperature		-55	175	°C
T_j	junction temperature		-55	175	°C
Avalanche ruggedness					
$E_{DS(AL)S}$	non-repetitive drain-source avalanche energy	$I_D = 58\text{ A}$; $V_{sup} \leq 40\text{ V}$; $R_{GS} = 50\text{ }\Omega$; $V_{GS} = 10\text{ V}$; $T_{j(init)} = 25\text{ °C}$; unclamped	-	85	mJ
$E_{DS(AL)R}$	repetitive drain-source avalanche energy	see Figure 3	[1][2] [3]	-	J
Source-drain diode					
I_S	source current	$T_{mb} = 25\text{ °C}$	-	58	A
I_{SM}	peak source current	$t_p \leq 10\text{ }\mu\text{s}$; pulsed; $T_{mb} = 25\text{ °C}$	-	234	A

[1] Single-pulse avalanche rating limited by maximum junction temperature of 175 °C.

[2] Repetitive avalanche rating limited by an average junction temperature of 170 °C.

[3] Refer to application note AN10273 for further information.

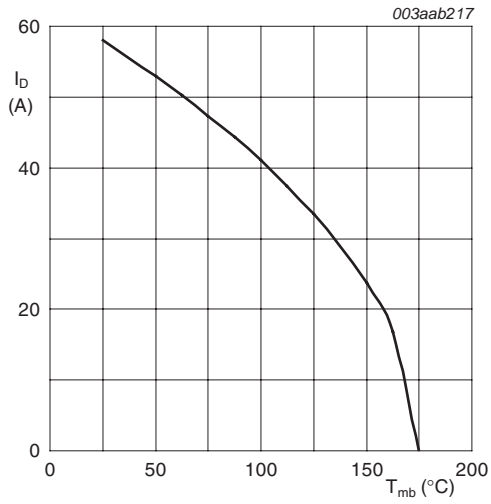

$V_{GS} \geq 10V$

Fig 1. Continuous drain current as a function of mounting base temperature

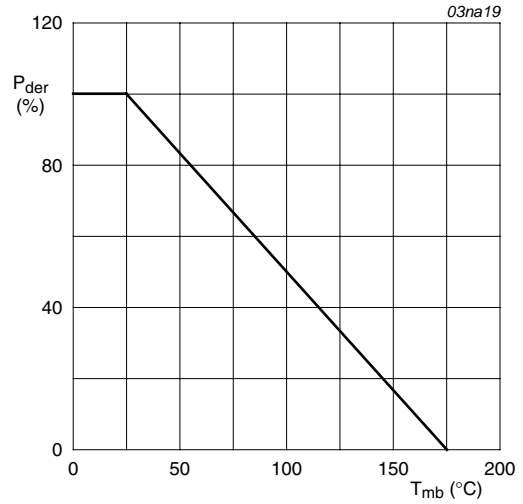

$$P_{der} = \frac{P_{tot}}{P_{tot(25^\circ C)}} \times 100\%$$

Fig 2. Normalized total power dissipation as a function of mounting base temperature

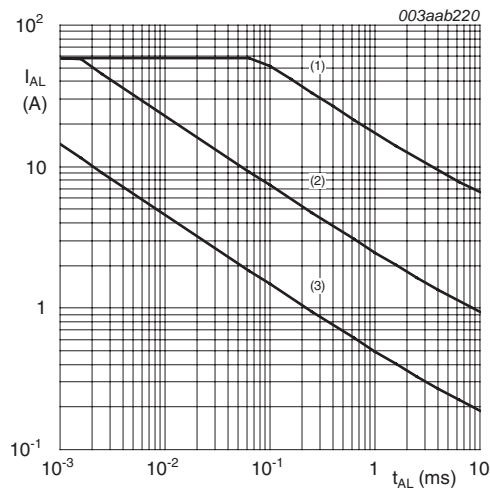

- (1) Single-pulse; $T_j = 25^\circ C$.
- (2) Single-pulse; $T_j = 150^\circ C$.
- (3) Repetitive.

Fig 3. Single-shot and repetitive avalanche rating; avalanche current as a function of avalanche period

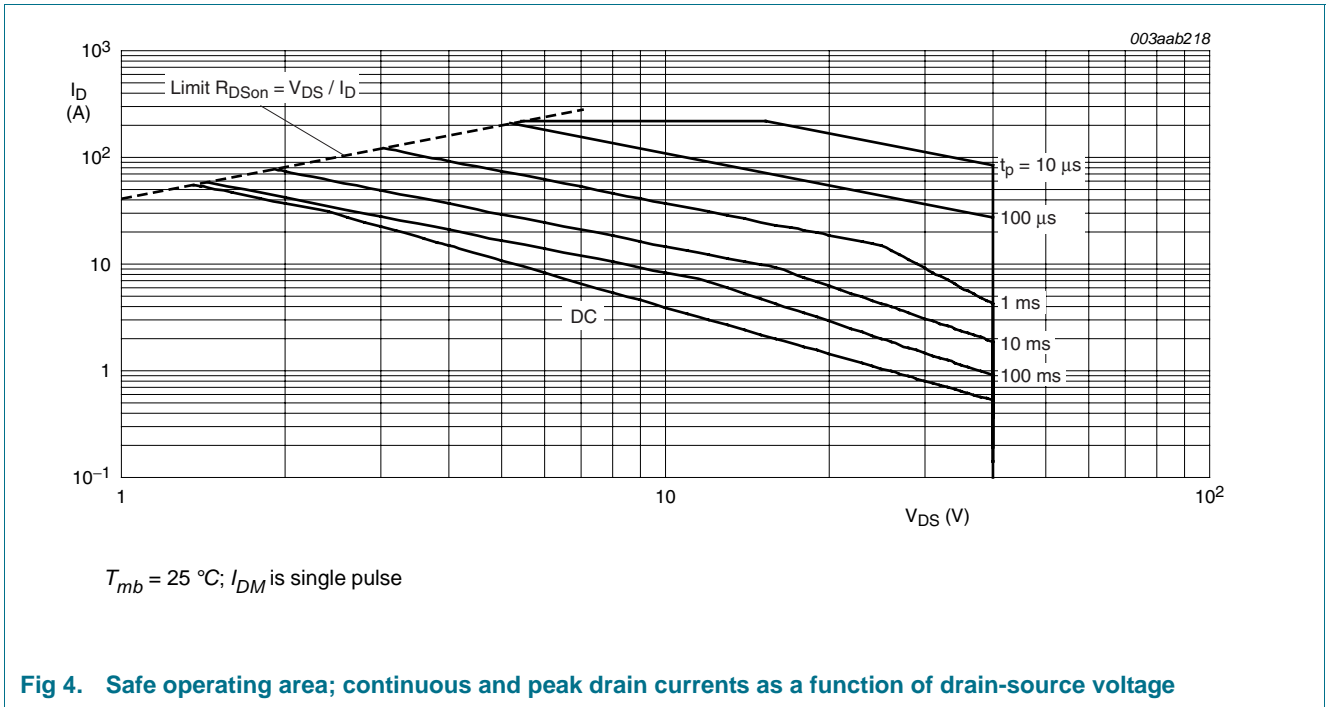

Fig 4. Safe operating area; continuous and peak drain currents as a function of drain-source voltage

5. Thermal characteristics

Table 5. Thermal characteristics

Symbol	Parameter	Conditions	Min	Typ	Max	Unit
$R_{th(j-mb)}$	thermal resistance from junction to mounting base	see Figure 5	-	-	1.8	K/W

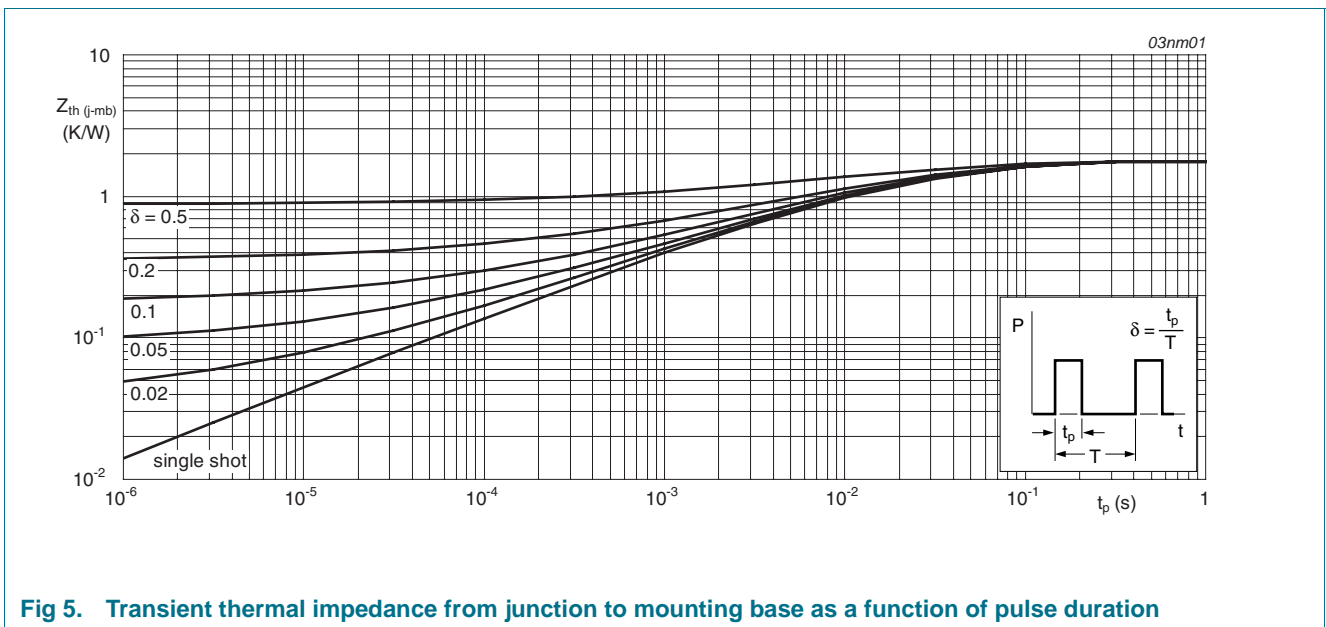

Fig 5. Transient thermal impedance from junction to mounting base as a function of pulse duration

6. Characteristics

Table 6. Characteristics

Symbol	Parameter	Conditions	Min	Typ	Max	Unit
Static characteristics						
$V_{(BR)DSS}$	drain-source breakdown voltage	$I_D = 250 \mu\text{A}; V_{GS} = 0 \text{ V}; T_j = 25 \text{ }^\circ\text{C}$	40	-	-	V
		$I_D = 250 \mu\text{A}; V_{GS} = 0 \text{ V}; T_j = -55 \text{ }^\circ\text{C}$	36	-	-	V
$V_{GS(th)}$	gate-source threshold voltage	$I_D = 1 \text{ mA}; V_{DS} = V_{GS}; T_j = 25 \text{ }^\circ\text{C};$ see Figure 10 and 11	2	3	4	V
		$I_D = 1 \text{ mA}; V_{DS} = V_{GS};$ $T_j = -55 \text{ }^\circ\text{C};$ see Figure 10	-	-	4.4	V
		$I_D = 1 \text{ mA}; V_{DS} = V_{GS};$ $T_j = 175 \text{ }^\circ\text{C};$ see Figure 10	1	-	-	V
I_{DSS}	drain leakage current	$V_{DS} = 40 \text{ V}; V_{GS} = 0 \text{ V};$ $T_j = 175 \text{ }^\circ\text{C}$	-	-	500	μA
		$V_{DS} = 40 \text{ V}; V_{GS} = 0 \text{ V}; T_j = 25 \text{ }^\circ\text{C}$	-	0.02	1	μA
I_{GSS}	gate leakage current	$V_{DS} = 0 \text{ V}; V_{GS} = 20 \text{ V}; T_j = 25 \text{ }^\circ\text{C}$	-	2	100	nA
		$V_{DS} = 0 \text{ V}; V_{GS} = -20 \text{ V};$ $T_j = 25 \text{ }^\circ\text{C}$	-	2	100	nA
$R_{DS(on)}$	drain-source on-state resistance	$V_{GS} = 10 \text{ V}; I_D = 25 \text{ A};$ $T_j = 175 \text{ }^\circ\text{C};$ see Figure 12	-	-	25	m Ω
		$V_{GS} = 10 \text{ V}; I_D = 25 \text{ A}; T_j = 25 \text{ }^\circ\text{C};$ see Figure 13 and 12	-	11	13	m Ω
Source-drain diode						
V_{SD}	source-drain voltage	$I_S = 25 \text{ A}; V_{GS} = 25 \text{ V}; T_j = 25 \text{ }^\circ\text{C};$ see Figure 16	-	0.85	1.2	V
t_{rr}	reverse recovery time	$I_S = 20 \text{ A}; di_S/dt = 100 \text{ A}/\mu\text{s};$	-	41	-	ns
Q_r	recovered charge	$V_{GS} = 0 \text{ V}; V_{DS} = 30 \text{ V}$	-	22	-	nC
Dynamic characteristics						
$Q_{G(tot)}$	total gate charge	$I_D = 10 \text{ A}; V_{DS} = 32 \text{ V};$	-	19	-	nC
Q_{GS}	gate-source charge	$V_{GS} = 10 \text{ V};$ see Figure 14	-	6	-	nC
Q_{GD}	gate-drain charge		-	5	-	nC
C_{iss}	input capacitance	$V_{GS} = 0 \text{ V}; V_{DS} = 25 \text{ V};$	-	983	1311	pF
C_{oss}	output capacitance	$f = 1 \text{ MHz}; T_j = 25 \text{ }^\circ\text{C};$ see Figure 15	-	280	336	pF
C_{riss}	reverse transfer capacitance		-	138	189	pF
$t_{d(on)}$	turn-on delay time	$V_{DS} = 30 \text{ V}; R_L = 2.5 \text{ } \Omega;$	-	9	-	ns
t_r	rise time	$V_{GS} = 10 \text{ V}; R_{G(ext)} = 10 \text{ } \Omega$	-	25	-	ns
$t_{d(off)}$	turn-off delay time		-	35	-	ns
t_f	fall time		-	27	-	ns

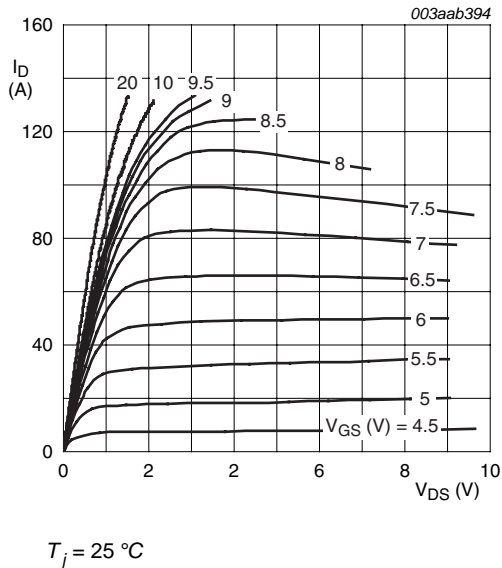

Fig 6. Output characteristics: drain current as a function of drain-source voltage; typical values

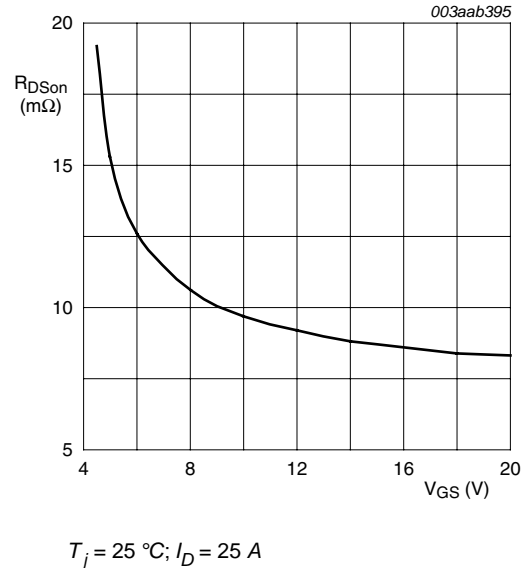

Fig 7. Drain-source on-state resistance as a function of gate-source voltage; typical values

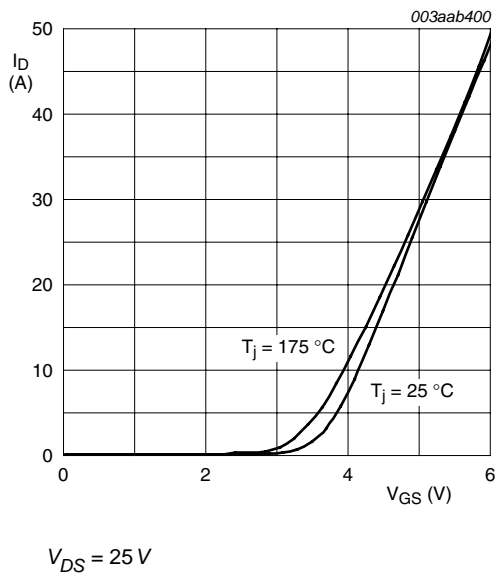

Fig 8. Transfer characteristics: drain current as a function of gate-source voltage; typical values

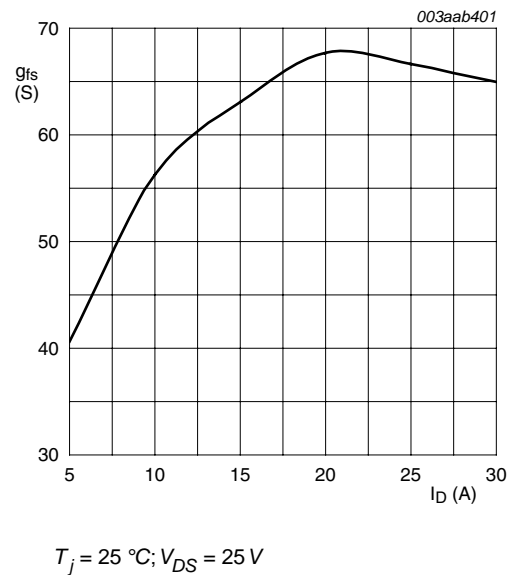
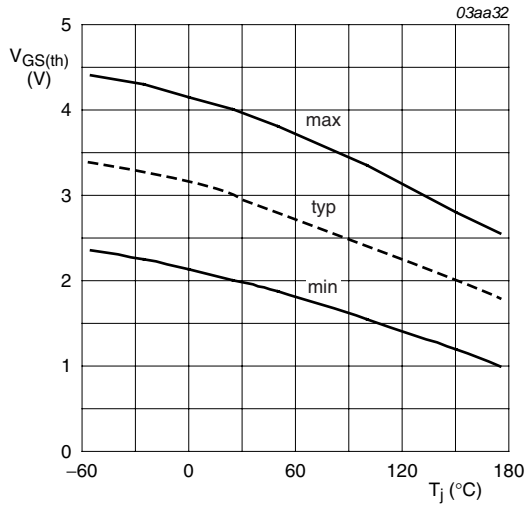
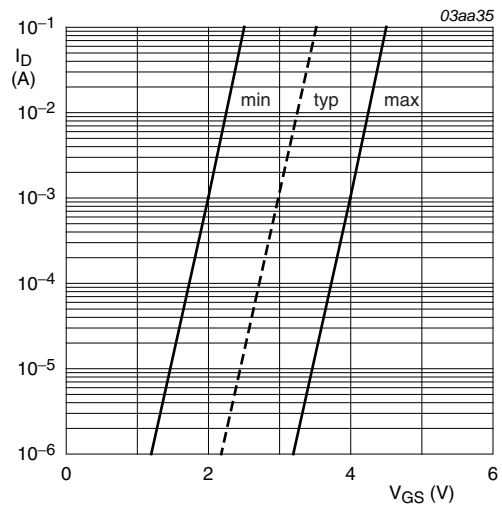

Fig 9. Forward transconductance as a function of drain current; typical values



$$I_D = 1 \text{ mA}; V_{DS} = V_{GS}$$

Fig 10. Gate-source threshold voltage as a function of junction temperature



$$T_j = 25 \text{ }^\circ\text{C}; V_{DS} = V_{GS}$$

Fig 11. Sub-threshold drain current as a function of gate-source voltage

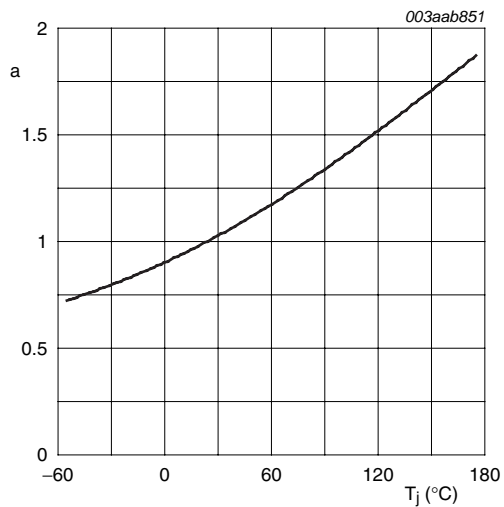

$$a = \frac{R_{DSon}}{R_{DSon(25^\circ\text{C})}}$$

Fig 12. Normalized drain-source on-state resistance factor as a function of junction temperature

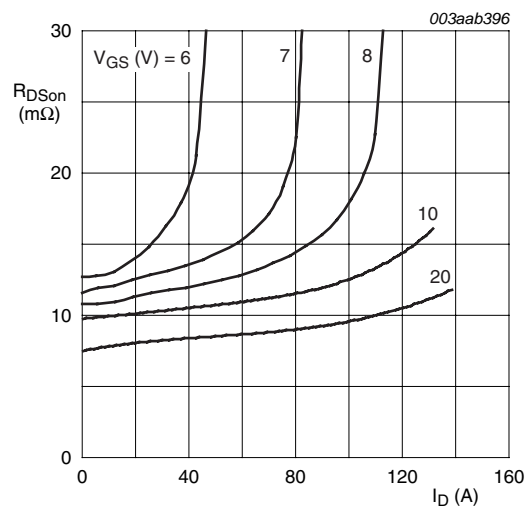

$$T_j = 25 \text{ }^\circ\text{C}$$

Fig 13. Drain-source on-state resistance as a function of drain current; typical values

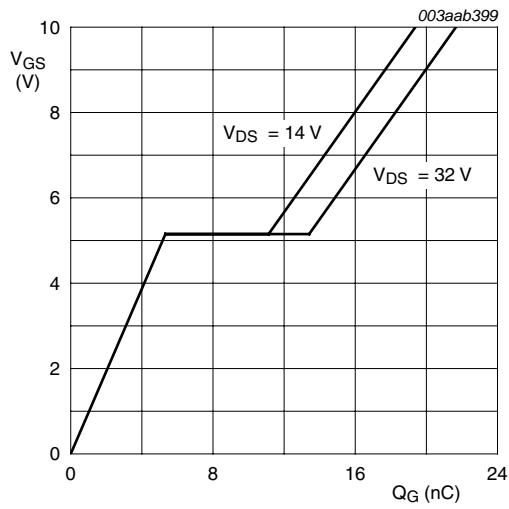

$T_j = 25\text{ }^\circ\text{C}; I_D = 10\text{ A}$

Fig 14. Gate-source voltage as a function of gate charge; typical values

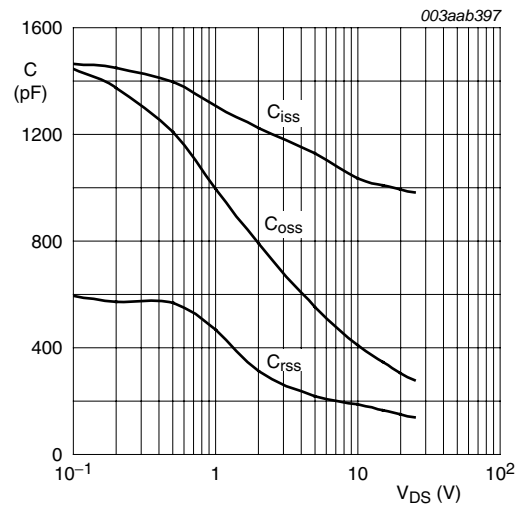

$V_{GS} = 0\text{ V}; f = 1\text{ MHz}$

Fig 15. Input, output and reverse transfer capacitances as a function of drain-source voltage; typical values

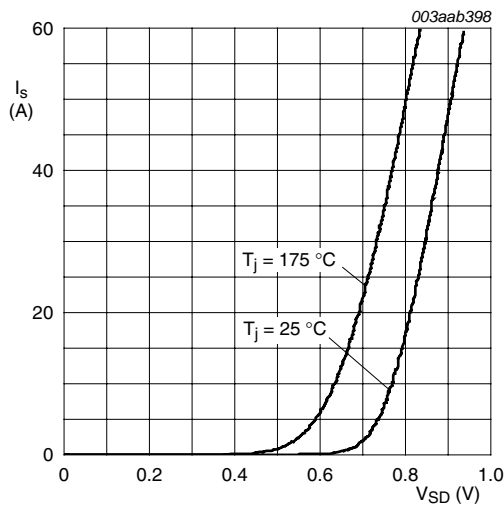

$V_{GS} = 0\text{ V}$

Fig 16. Source current as a function of source-drain voltage; typical values

7. Package outline

Plastic single-ended surface-mounted package (LPAK); 4 leads

SOT669

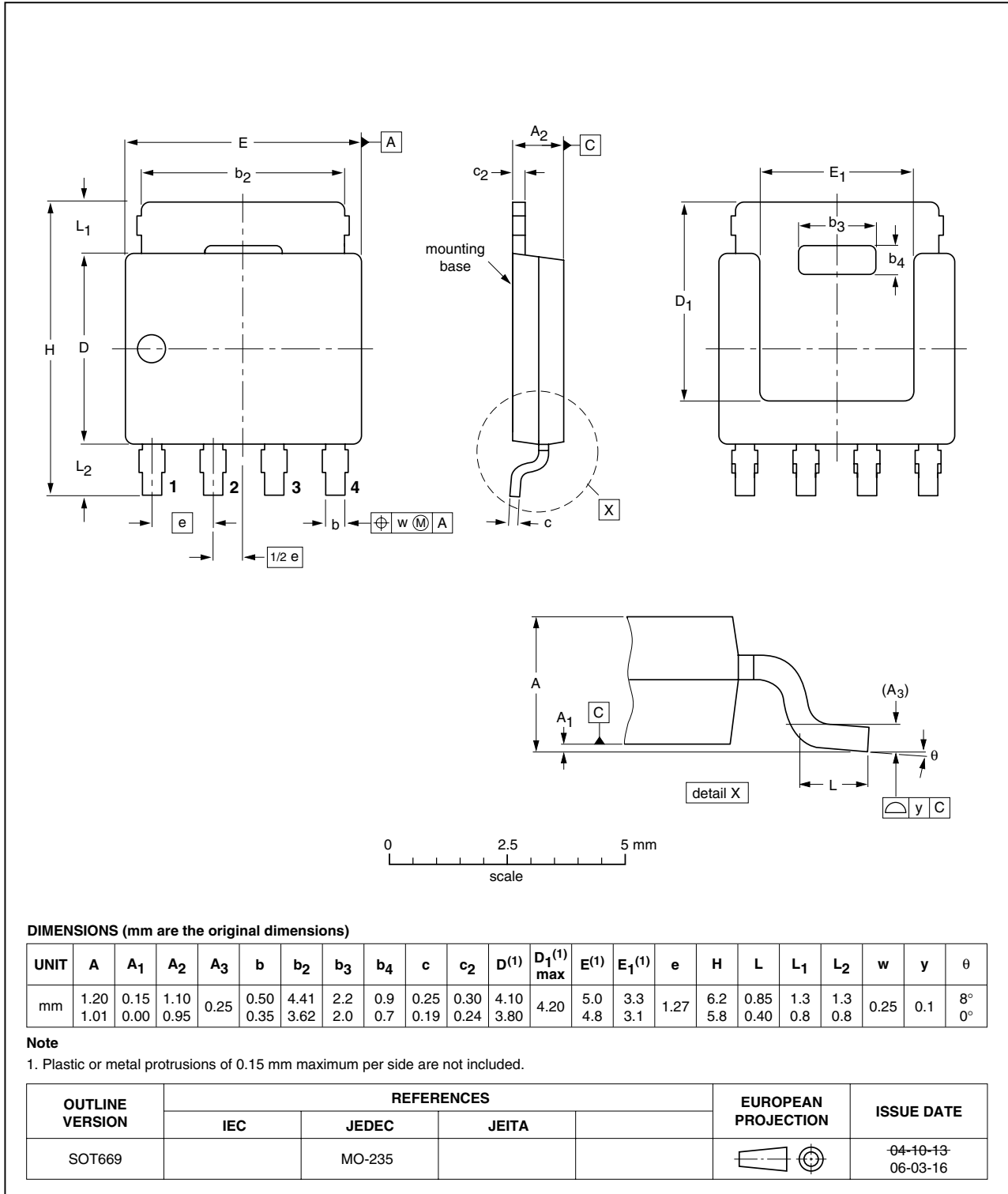

Fig 17. Package outline SOT669 (LPAK)

8. Revision history

Table 7. Revision history

Document ID	Release date	Data sheet status	Change notice	Supersedes
BUK7Y13-40B_3	20080526	Product data sheet	-	BUK7Y13-40B_2
Modifications:	• Table 5 , maximum thermal resistance value updated			
BUK7Y13-40B_2	20071002	Product data sheet	-	BUK7Y13-40B_1
BUK7Y13-40B_1	20070924	Product data sheet	-	-

9. Legal information

9.1 Data sheet status

Document status ^{[1][2]}	Product status ^[3]	Definition
Objective [short] data sheet	Development	This document contains data from the objective specification for product development.
Preliminary [short] data sheet	Qualification	This document contains data from the preliminary specification.
Product [short] data sheet	Production	This document contains the product specification.

[1] Please consult the most recently issued document before initiating or completing a design.

[2] The term 'short data sheet' is explained in section "Definitions".

[3] The product status of device(s) described in this document may have changed since this document was published and may differ in case of multiple devices. The latest product status information is available on the internet at URL <http://www.nexperia.com>.

9.2 Definitions

Draft — The document is a draft version only. The content is still under internal review and subject to formal approval, which may result in modifications or additions. Nexperia does not give any representations or warranties as to the accuracy or completeness of information included herein and shall have no liability for the consequences of use of such information.

Short data sheet — A short data sheet is an extract from a full data sheet with the same product type number(s) and title. A short data sheet is intended for quick reference only and should not be relied upon to contain detailed and full information. For detailed and full information see the relevant full data sheet, which is available on request via the local Nexperia sales office. In case of any inconsistency or conflict with the short data sheet, the full data sheet shall prevail.

9.3 Disclaimers

General — Information in this document is believed to be accurate and reliable. However, Nexperia does not give any representations or warranties, expressed or implied, as to the accuracy or completeness of such information and shall have no liability for the consequences of use of such information.

Right to make changes — Nexperia reserves the right to make changes to information published in this document, including without limitation specifications and product descriptions, at any time and without notice. This document supersedes and replaces all information supplied prior to the publication hereof.

Suitability for use — Nexperia products are not designed, authorized or warranted to be suitable for use in medical, military, aircraft, space or life support equipment, nor in applications where failure or malfunction of a Nexperia product can reasonably be expected to result in personal injury, death or severe property or environmental

damage. Nexperia accepts no liability for inclusion and/or use of Nexperia products in such equipment or applications and therefore such inclusion and/or use is at the customer's own risk.

Applications — Applications that are described herein for any of these products are for illustrative purposes only. Nexperia makes no representation or warranty that such applications will be suitable for the specified use without further testing or modification.

Quick reference data — The Quick reference data is an extract of the product data given in the Limiting values and Characteristics sections of this document, and as such is not complete, exhaustive or legally binding.

Limiting values — Stress above one or more limiting values (as defined in the Absolute Maximum Ratings System of IEC 60134) may cause permanent damage to the device. Limiting values are stress ratings only and operation of the device at these or any other conditions above those given in the Characteristics sections of this document is not implied. Exposure to limiting values for extended periods may affect device reliability.

Terms and conditions of sale — Nexperia products are sold subject to the general terms and conditions of commercial sale, as published at <http://www.nexperia.com/profile/terms>, including those pertaining to warranty, intellectual property rights infringement and limitation of liability, unless explicitly otherwise agreed to in writing by Nexperia. In case of any inconsistency or conflict between information in this document and such terms and conditions, the latter will prevail.

No offer to sell or license — Nothing in this document may be interpreted or construed as an offer to sell products that is open for acceptance or the grant, conveyance or implication of any license under any copyrights, patents or other industrial or intellectual property rights.

9.4 Trademarks

Notice: All referenced brands, product names, service names and trademarks are the property of their respective owners.

10. Contact information

For additional information, please visit: <http://www.nexperia.com>

For sales office addresses, send an email to: salesaddresses@nexperia.com

11. Contents

1	Product profile	1
1.1	General description	1
1.2	Features and benefits	1
1.3	Applications	1
1.4	Quick reference data	1
2	Pinning information	2
3	Ordering information	2
4	Limiting values	2
5	Thermal characteristics	4
6	Characteristics	5
7	Package outline	9
8	Revision history	10
9	Legal information	11
9.1	Data sheet status	11
9.2	Definitions	11
9.3	Disclaimers	11
9.4	Trademarks	11
10	Contact information	11
11	Contents	12

单击下面可查看定价，库存，交付和生命周期等信息

[>>Nexperia\(安世\)](#)