



# BZX384 series

## Voltage regulator diodes

Rev. 4 — 1 January 2023

Product data sheet

## 1. General description

Low-power voltage regulator diodes in a small SOD323 (SC-76) Surface-Mounted Device (SMD) plastic package.

The diodes are available in the normalized E24  $\pm 1\%$  (BZX384-A),  $\pm 2\%$  (BZX384-B) and approximately  $\pm 5\%$  (BZX384-C) tolerance range. The series includes 37 breakdown voltages with nominal working voltages from 2.4 V to 75 V.

## 2. Features and benefits

- Total power dissipation:  $\leq 300$  mW
- Three tolerance series:  $\pm 1\%$ ,  $\pm 2\%$  and approximately  $\pm 5\%$
- Working voltage range: nominal 2.4 V to 75 V (E24 range)
- Non-repetitive peak reverse power dissipation:  $\leq 40$  W

## 3. Applications

- General regulation functions

## 4. Quick reference data

Table 1. Quick reference data

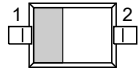
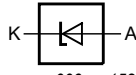
Symbol	Parameter	Conditions		Min	Typ	Max	Unit
$V_F$	forward voltage	$I_F = 10$ mA	[1]	-	-	0.9	V
$P_{tot}$	total power dissipation	$T_{amb} \leq 25$ °C	[2]	-	-	300	mW

[1] Pulse test:  $t_p \leq 100$   $\mu$ s;  $\delta \leq 0.02$ .

[2] Device mounted on an FR4 Printed-Circuit Board (PCB), single-sided copper, tin-plated and standard footprint.

## 5. Pinning information

Table 2. Pinning

Pin	Symbol	Description		Simplified outline	Graphic symbol
1	K	cathode	[1]		 006aaa152
2	A	anode			

[1] The marking bar indicates the cathode.

## 6. Ordering information

Table 3. Ordering information

Type number	Package		
	Name	Description	Version
BZX384 series[1]	SC-76	plastic surface-mounted package; 2 leads	SOD323

[1] The series consists of 111 types with 37 breakdown voltages with nominal working voltages from 2.4 V to 75 V and  $\pm 1\%$ ,  $\pm 2\%$  and  $\pm 5\%$  tolerances.

## 7. Marking

Table 4. Marking codes

Type number	Marking code	Type number	Marking code	Type number	Marking code
BZX384-A2V4	2B	BZX384-B2V4	K1	BZX384-C2V4	T3
BZX384-A2V7	2U	BZX384-B2V7	K2	BZX384-C2V7	T4
BZX384-A3V0	2V	BZX384-B3V0	K3	BZX384-C3V0	T5
BZX384-A3V3	2W	BZX384-B3V3	K4	BZX384-C3V3	T6
BZX384-A3V6	2X	BZX384-B3V6	K5	BZX384-C3V6	T7
BZX384-A3V9	2Y	BZX384-B3V9	K6	BZX384-C3V9	T8
BZX384-A4V3	2Z	BZX384-B4V3	K7	BZX384-C4V3	T9
BZX384-A4V7	22	BZX384-B4V7	K8	BZX384-C4V7	T0
BZX384-A5V1	23	BZX384-B5V1	K9	BZX384-C5V1	D5
BZX384-A5V6	24	BZX384-B5V6	L1	BZX384-C5V6	D6
BZX384-A6V2	25	BZX384-B6V2	L2	BZX384-C6V2	T1
BZX384-A6V8	26	BZX384-B6V8	L3	BZX384-C6V8	D7
BZX384-A7V5	27	BZX384-B7V5	L4	BZX384-C7V5	D8
BZX384-A8V2	28	BZX384-B8V2	L5	BZX384-C8V2	D9
BZX384-A9V1	29	BZX384-B9V1	L6	BZX384-C9V1	D0
BZX384-A10	3X	BZX384-B10	L7	BZX384-C10	T2
BZX384-A11	32	BZX384-B11	L8	BZX384-C11	DA
BZX384-A12	33	BZX384-B12	L9	BZX384-C12	DB
BZX384-A13	34	BZX384-B13	M1	BZX384-C13	DC
BZX384-A15	35	BZX384-B15	M2	BZX384-C15	DD
BZX384-A16	36	BZX384-B16	M3	BZX384-C16	DE
BZX384-A18	37	BZX384-B18	M4	BZX384-C18	DF
BZX384-A20	38	BZX384-B20	M5	BZX384-C20	DG
BZX384-A22	39	BZX384-B22	M6	BZX384-C22	DH
BZX384-A24	4N	BZX384-B24	M7	BZX384-C24	DJ
BZX384-A27	4P	BZX384-B27	M8	BZX384-C27	DK
BZX384-A30	5F	BZX384-B30	M9	BZX384-C30	DL
BZX384-A33	4R	BZX384-B33	N0	BZX384-C33	DM
BZX384-A36	4S	BZX384-B36	N1	BZX384-C36	DN
BZX384-A39	4T	BZX384-B39	N2	BZX384-C39	DP
BZX384-A43	4U	BZX384-B43	N3	BZX384-C43	DR
BZX384-A47	4V	BZX384-B47	N4	BZX384-C47	DS
BZX384-A51	4W	BZX384-B51	N5	BZX384-C51	DT
BZX384-A56	4X	BZX384-B56	N6	BZX384-C56	DU
BZX384-A62	4Y	BZX384-B62	N7	BZX384-C62	DV
BZX384-A68	4Z	BZX384-B68	N8	BZX384-C68	DW
BZX384-A75	42	BZX384-B75	N9	BZX384-C75	DX

## 8. Limiting values

**Table 5. Limiting values**

In accordance with the Absolute Maximum Rating System (IEC 60134).

Symbol	Parameter	Conditions	Min	Max	Unit
$I_F$	forward current		-	250	mA
$I_{ZSM}$	non-repetitive peak reverse current		[1] -	see Tables 8 and 9	
$P_{ZSM}$	non-repetitive peak reverse power dissipation		[1] -	40	W
$P_{tot}$	total power dissipation	$T_{amb} \leq 25\text{ °C}$	[2] -	300	mW
$T_j$	junction temperature		-	150	°C
$T_{amb}$	ambient temperature		-65	+150	°C
$T_{stg}$	storage temperature		-65	+150	°C

[1]  $t_p = 100\text{ }\mu\text{s}$ ; square wave;  $T_j = 25\text{ °C}$  prior to surge.

[2] Device mounted on an FR4 PCB, single-sided copper, tin-plated and standard footprint.

## 9. Thermal characteristics

**Table 6. Thermal characteristics**

Symbol	Parameter	Conditions	Min	Typ	Max	Unit
$R_{th(j-a)}$	thermal resistance from junction to ambient	in free air	[1] -	-	415	K/W
$R_{th(j-sp)}$	thermal resistance from junction to solder point		[2] -	-	110	K/W

[1] Device mounted on an FR4 PCB, single-sided copper, tin-plated and standard footprint.

[2] Soldering point of cathode tab.

## 10. Characteristics

**Table 7. Characteristics**

$T_j = 25\text{ °C}$  unless otherwise specified.

Symbol	Parameter	Conditions	Min	Typ	Max	Unit
$V_F$	forward voltage	$I_F = 10\text{ mA}$	[1] -	-	0.9	V
		$I_F = 100\text{ mA}$	[1] -	-	1.1	V

[1] Pulse test:  $t_p \leq 100\text{ }\mu\text{s}$ ;  $\delta \leq 0.02$ .

Table 8. Characteristics per type; BZX384-A2V4 to BZX384-C24

 $T_j = 25\text{ °C}$  unless otherwise specified.

BZX384 -xxx	Sel	Working voltage $V_Z$ (V) $I_Z = 5\text{ mA}$		Maximum differential resistance $r_{\text{dif}}$ ( $\Omega$ )		Reverse current $I_R$ ( $\mu\text{A}$ )		Temperature coefficient $S_Z$ (mV/K) $I_Z = 5\text{ mA}$		Diode capacitance $C_d$ (pF) [1]	Non-repetitive peak reverse current $I_{ZSM}$ (A) [2]
		Min	Max	$I_Z = 1\text{ mA}$	$I_Z = 5\text{ mA}$	Max	$V_R$ (V)	Min	Max	Max	Max
2V4	A	2.37	2.43	600	100	50	1	-3.5	0.0	450	6.0
	B	2.35	2.45								
	C	2.20	2.60								
2V7	A	2.67	2.73	600	100	20	1	-3.5	0.0	450	6.0
	B	2.65	2.75								
	C	2.50	2.90								
3V0	A	2.97	3.03	600	95	10	1	-3.5	0.0	450	6.0
	B	2.94	3.06								
	C	2.80	3.20								
3V3	A	3.26	3.34	600	95	5	1	-3.5	0.0	450	6.0
	B	3.23	3.37								
	C	3.10	3.50								
3V6	A	3.56	3.64	600	90	5	1	-3.5	0.0	450	6.0
	B	3.53	3.67								
	C	3.40	3.80								
3V9	A	3.86	3.94	600	90	3	1	-3.5	0.0	450	6.0
	B	3.82	3.98								
	C	3.70	4.10								
4V3	A	4.25	4.35	600	90	3	1	-3.5	0.0	450	6.0
	B	4.21	4.39								
	C	4.00	4.60								
4V7	A	4.65	4.75	500	80	3	2	-3.5	0.2	300	6.0
	B	4.61	4.79								
	C	4.40	5.00								
5V1	A	5.04	5.16	480	60	2	2	-2.7	1.2	300	6.0
	B	5.00	5.20								
	C	4.80	5.40								
5V6	A	5.54	5.66	400	40	1	2	-2.0	2.5	300	6.0
	B	5.49	5.71								
	C	5.20	6.00								
6V2	A	6.13	6.27	150	10	3	4	0.4	3.7	200	6.0
	B	6.08	6.32								
	C	5.80	6.60								
6V8	A	6.73	6.87	80	15	2	4	1.2	4.5	200	6.0
	B	6.66	6.94								
	C	6.40	7.20								
7V5	A	7.42	7.58	80	15	1	5	2.5	5.3	150	4.0
	B	7.35	7.65								
	C	7.00	7.90								

BZX384 -xxx	Sel	Working voltage $V_Z$ (V) $I_Z = 5$ mA		Maximum differential resistance $r_{dif}$ ( $\Omega$ )		Reverse current $I_R$ ( $\mu$ A)		Temperature coefficient $S_Z$ (mV/K) $I_Z = 5$ mA		Diode capacitance $C_d$ (pF) [1]	Non-repetitive peak reverse current $I_{ZSM}$ (A) [2]
		Min	Max	$I_Z = 1$ mA	$I_Z = 5$ mA	Max	$V_R$ (V)	Min	Max	Max	Max
8V2	A	8.11	8.29	80	15	0.7	5	3.2	6.2	150	4.0
	B	8.04	8.36								
	C	7.70	8.70								
9V1	A	9.00	9.20	100	15	0.5	6	3.8	7.0	150	3.0
	B	8.92	9.28								
	C	8.50	9.60								
10	A	9.90	10.10	150	20	0.2	7	4.5	8.0	90	3.0
	B	9.80	10.20								
	C	9.40	10.60								
11	A	10.89	11.11	150	20	0.1	8	5.4	9.0	85	2.5
	B	10.80	11.20								
	C	10.40	11.60								
12	A	11.88	12.12	150	25	0.1	8	6.0	10.0	85	2.5
	B	11.80	12.20								
	C	11.40	12.70								
13	A	12.87	13.13	170	30	0.1	8	7.0	11.0	80	2.5
	B	12.70	13.30								
	C	12.40	14.10								
15	A	14.85	15.15	200	30	0.05	10.5	9.2	13.0	75	2.0
	B	14.70	15.30								
	C	13.80	15.60								
16	A	15.84	16.16	200	40	0.05	11.2	10.4	14.0	75	1.5
	B	15.70	16.30								
	C	15.30	17.10								
18	A	17.82	18.18	225	45	0.05	12.6	12.4	16.0	70	1.5
	B	17.60	18.40								
	C	16.80	19.10								
20	A	19.80	20.20	225	55	0.05	14	14.4	18.0	60	1.5
	B	19.60	20.40								
	C	18.80	21.20								
22	A	21.78	22.22	250	55	0.05	15.4	16.4	20.0	60	1.25
	B	21.60	22.40								
	C	20.80	23.30								
24	A	23.76	24.24	250	70	0.05	16.8	18.4	22.0	55	1.25
	B	23.50	24.50								
	C	22.80	25.60								

[1]  $f = 1$  MHz;  $V_R = 0$  V

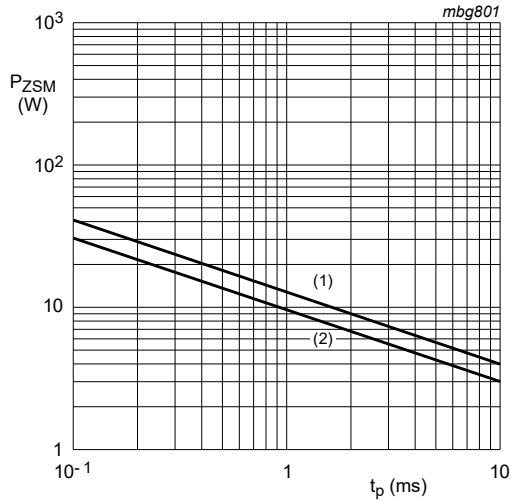
[2]  $t_p = 100$   $\mu$ s; square wave;  $T_j = 25$  °C

Table 9. Characteristics per type; BZX384-A27 to BZX384-C75

 $T_j = 25\text{ °C}$  unless otherwise specified.

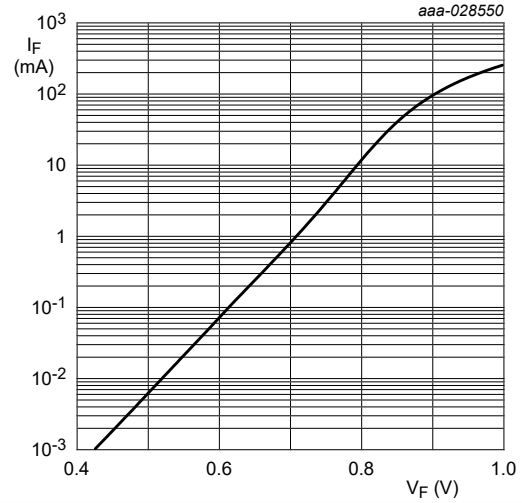
BZX384 -xxx	Sel	Working voltage $V_Z$ (V) $I_Z = 2\text{ mA}$		Maximum differential resistance $r_{\text{dif}}$ ( $\Omega$ )		Reverse current $I_R$ ( $\mu\text{A}$ )		Temperature coefficient $S_Z$ (mV/K) $I_Z = 2\text{ mA}$		Diode capacitance $C_d$ (pF) [1]	Non-repetitive peak reverse current $I_{ZSM}$ (A) [2]
		Min	Max	$I_Z = 0.5\text{ mA}$	$I_Z = 2\text{ mA}$	Max	$V_R$ (V)	Min	Max	Max	Max
27	A	26.73	27.27	300	80	0.05	18.9	21.4	25.3	50	1.0
	B	26.50	27.50								
	C	25.10	28.90								
30	A	29.70	30.30	300	80	0.05	21	24.4	29.4	50	1.0
	B	29.40	30.60								
	C	28.00	32.00								
33	A	32.67	33.33	325	80	0.05	23.1	27.4	33.4	45	0.9
	B	32.30	33.70								
	C	31.00	35.00								
36	A	35.64	36.36	350	90	0.05	25.2	30.4	37.4	45	0.8
	B	35.30	36.70								
	C	34.00	38.00								
39	A	38.61	39.39	350	130	0.05	27.3	33.4	41.2	45	0.7
	B	38.20	39.80								
	C	37.00	41.00								
43	A	42.57	43.43	375	150	0.05	30.1	37.6	46.6	40	0.6
	B	42.10	43.90								
	C	40.00	46.00								
47	A	46.53	47.47	375	170	0.05	32.9	42.0	51.8	40	0.5
	B	46.10	47.90								
	C	44.00	50.00								
51	A	50.49	51.51	400	180	0.05	35.7	46.6	57.2	40	0.4
	B	50.00	52.00								
	C	48.00	54.00								
56	A	55.44	56.56	425	200	0.05	39.2	52.2	63.8	40	0.3
	B	54.90	57.10								
	C	52.00	60.00								
62	A	61.38	62.62	450	215	0.05	43.4	58.8	71.6	35	0.3
	B	60.80	63.20								
	C	58.00	66.00								
68	A	67.32	68.68	475	240	0.05	47.6	65.6	79.8	35	0.25
	B	66.60	69.40								
	C	64.00	72.00								
75	A	74.25	75.75	500	255	0.05	52.5	73.4	88.6	35	0.20
	B	73.50	76.50								
	C	70.00	79.00								

[1]  $f = 1\text{ MHz}$ ;  $V_R = 0\text{ V}$ [2]  $t_p = 100\text{ }\mu\text{s}$ ; square wave;  $T_j = 25\text{ °C}$



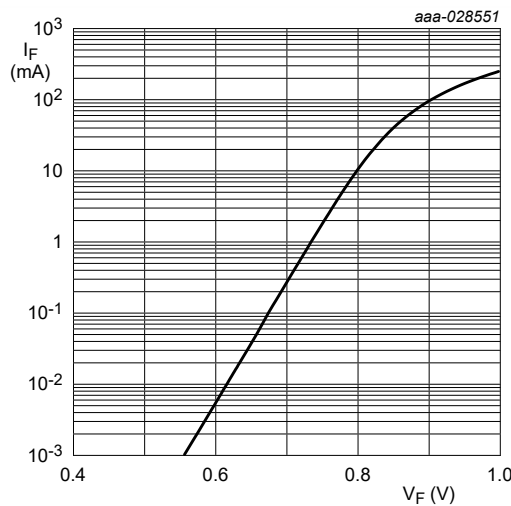
(1)  $T_j = 25^\circ\text{C}$  (before surge)  
 (2)  $T_j = 150^\circ\text{C}$  (before surge)

**Fig. 1.** Non-repetitive peak reverse power dissipation as a function of pulse duration; maximum values



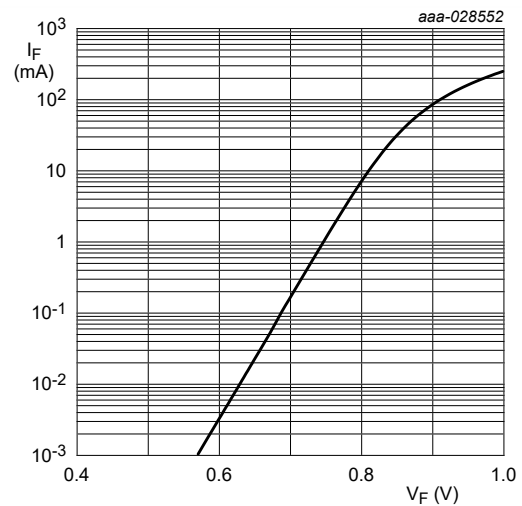
$T_j = 25^\circ\text{C}$

**Fig. 2.** Forward current as a function of forward voltage; typical values (BZX384-A/B/C2V4)



$T_j = 25^\circ\text{C}$

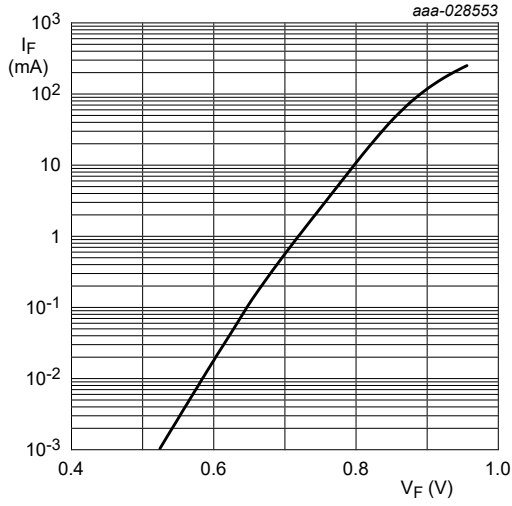
**Fig. 3.** Forward current as a function of forward voltage; typical values (BZX384-A/B/C6V8)



$T_j = 25^\circ\text{C}$

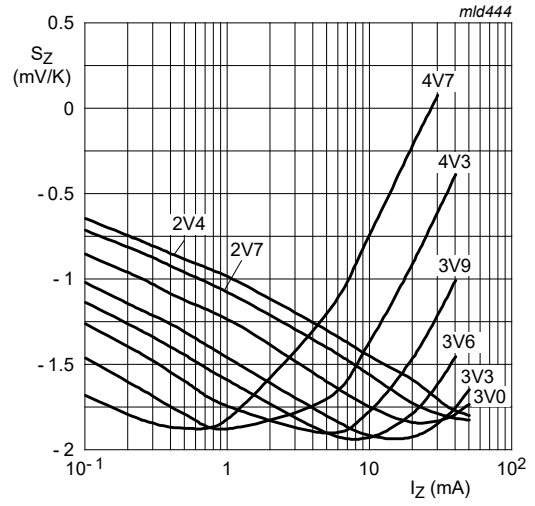
**Fig. 4.** Forward current as a function of forward voltage; typical values (BZX384-A/B/C7V5)





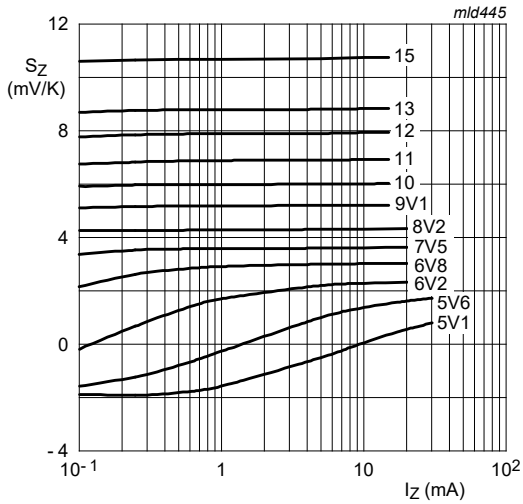
$T_j = 25\text{ }^\circ\text{C}$

**Fig. 5. Forward current as a function of forward voltage; typical values (BZX384-A/B/C75)**



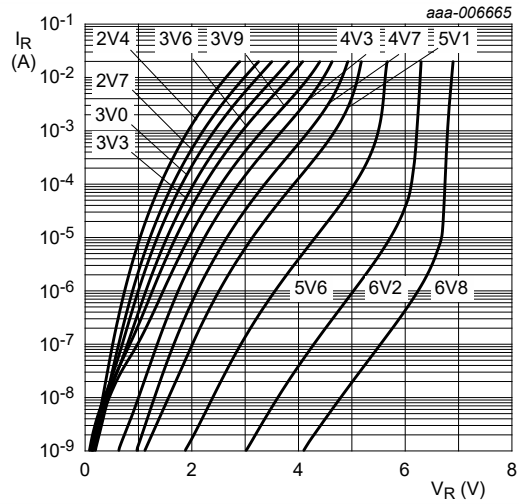
$T_j = 25\text{ }^\circ\text{C to } 150\text{ }^\circ\text{C}$

**Fig. 6. Temperature coefficient as a function of working current; typical values (BZX384-A/B/C2V4 to BZX384-A/B/C4V7)**



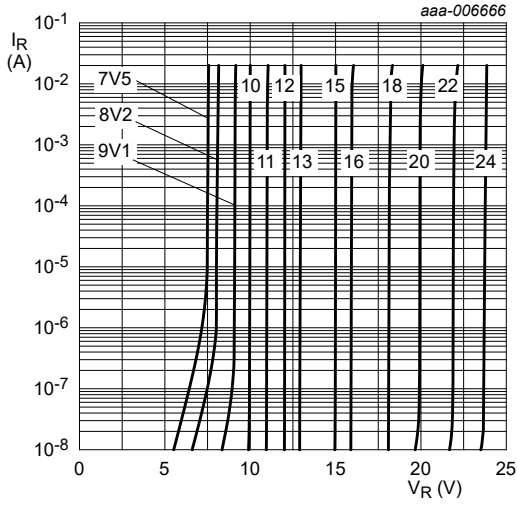
$T_j = 25\text{ }^\circ\text{C to } 150\text{ }^\circ\text{C}$

**Fig. 7. Temperature coefficient as a function of working current; typical values (BZX384-A/B/C5V1 to BZX384-A/B/C15)**



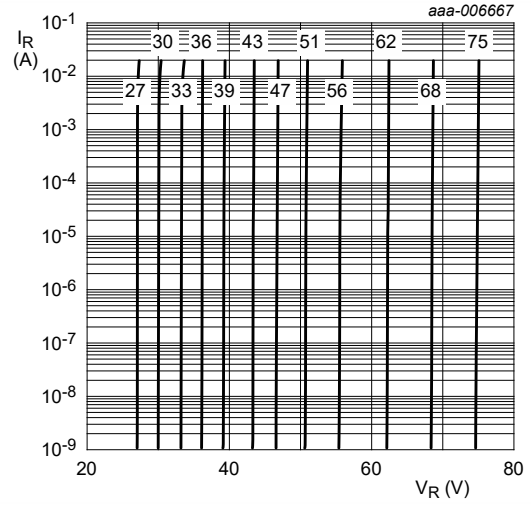
$T_j = 25\text{ }^\circ\text{C}$

**Fig. 8. Reverse current as a function of reverse voltage; typical values (BZX384-A/B/C2V4 to BZX384-A/B/C6V8)**



$T_j = 25\text{ }^\circ\text{C}$

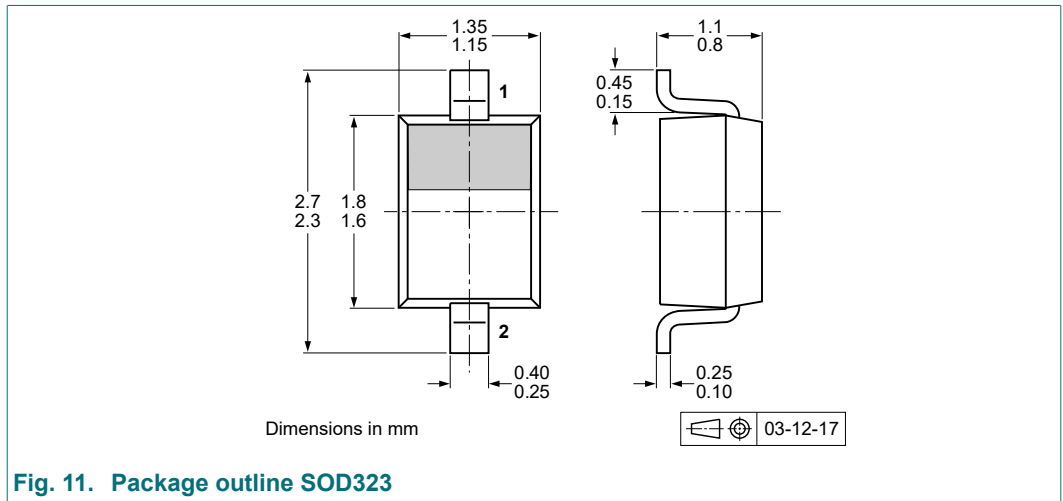
**Fig. 9. Reverse current as a function of reverse voltage; typical values (BZX384-A/B/C7V5 to BZX384-A/B/C24)**



$T_j = 25\text{ }^\circ\text{C}$

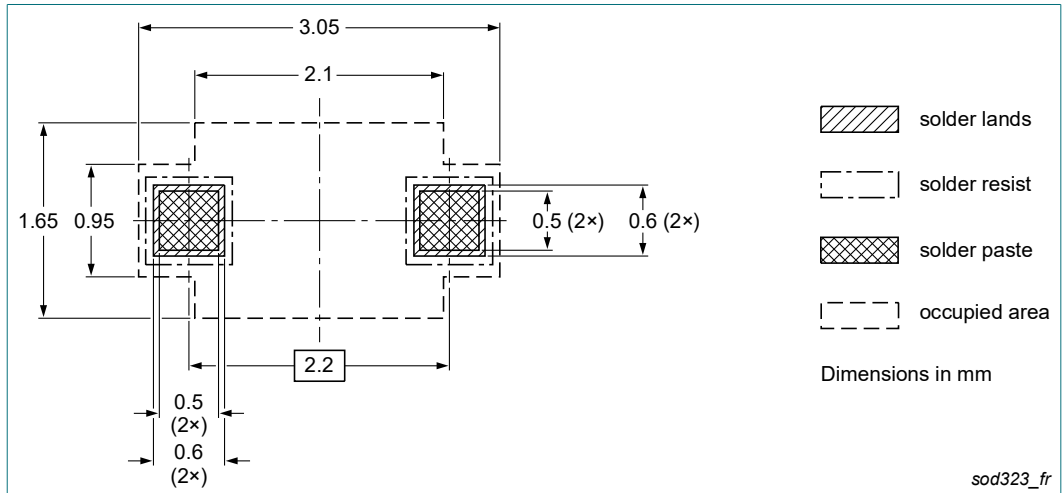
**Fig. 10. Reverse current as a function of reverse voltage; typical values (BZX384-A/B/C27 to BZX384-A/B/C75)**

## 11. Package outline

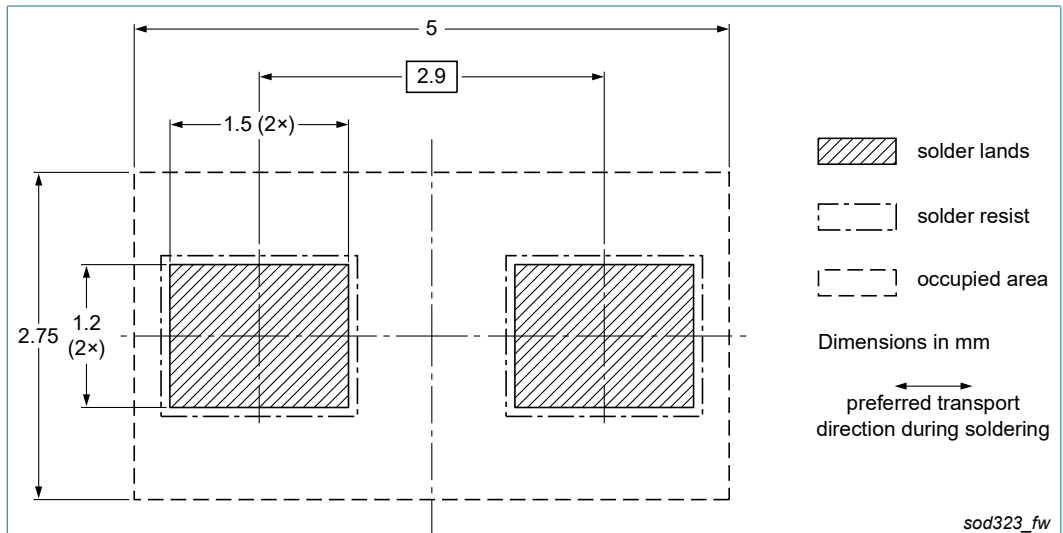


**Fig. 11. Package outline SOD323**

## 12. Soldering



**Fig. 12. Reflow soldering footprint for SOD323 (SC-76)**



**Fig. 13. Wave soldering footprint for SOD323 (SC-76)**

## 13. Revision history

Table 10. Revision history

Document ID	Release date	Data sheet status	Change notice	Supersedes
BZX384_SER v.4	20230101	Product data sheet	-	BZX384_SER v.3
Modifications:	<ul style="list-style-type: none"> <li>• BZX384-A selections added</li> <li>• Products changed to non-automotive qualification. Please refer to nexperia.com for automotive (-Q) product alternatives.</li> <li>• Limiting values: Temperature specification adjusted</li> </ul>			
BZX384_SER v.3	20161011	Product data sheet	-	BZX384_SER v.2
BZX384_SER v.2	20040322	Product data sheet	-	BZX384_SER v.1
BZX384_SER v.1	20030401	Product data sheet	-	-

## 14. Legal information

### Data sheet status

Document status [1][2]	Product status [3]	Definition
Objective [short] data sheet	Development	This document contains data from the objective specification for product development.
Preliminary [short] data sheet	Qualification	This document contains data from the preliminary specification.
Product [short] data sheet	Production	This document contains the product specification.

- [1] Please consult the most recently issued document before initiating or completing a design.
- [2] The term 'short data sheet' is explained in section "Definitions".
- [3] The product status of device(s) described in this document may have changed since this document was published and may differ in case of multiple devices. The latest product status information is available on the internet at <https://www.nexperia.com>.

### Definitions

**Draft** — The document is a draft version only. The content is still under internal review and subject to formal approval, which may result in modifications or additions. Nexperia does not give any representations or warranties as to the accuracy or completeness of information included herein and shall have no liability for the consequences of use of such information.

**Short data sheet** — A short data sheet is an extract from a full data sheet with the same product type number(s) and title. A short data sheet is intended for quick reference only and should not be relied upon to contain detailed and full information. For detailed and full information see the relevant full data sheet, which is available on request via the local Nexperia sales office. In case of any inconsistency or conflict with the short data sheet, the full data sheet shall prevail.

**Product specification** — The information and data provided in a Product data sheet shall define the specification of the product as agreed between Nexperia and its customer, unless Nexperia and customer have explicitly agreed otherwise in writing. In no event however, shall an agreement be valid in which the Nexperia product is deemed to offer functions and qualities beyond those described in the Product data sheet.

### Disclaimers

**Limited warranty and liability** — Information in this document is believed to be accurate and reliable. However, Nexperia does not give any representations or warranties, expressed or implied, as to the accuracy or completeness of such information and shall have no liability for the consequences of use of such information. Nexperia takes no responsibility for the content in this document if provided by an information source outside of Nexperia.

In no event shall Nexperia be liable for any indirect, incidental, punitive, special or consequential damages (including - without limitation - lost profits, lost savings, business interruption, costs related to the removal or replacement of any products or rework charges) whether or not such damages are based on tort (including negligence), warranty, breach of contract or any other legal theory.

Notwithstanding any damages that customer might incur for any reason whatsoever, Nexperia's aggregate and cumulative liability towards customer for the products described herein shall be limited in accordance with the Terms and conditions of commercial sale of Nexperia.

**Right to make changes** — Nexperia reserves the right to make changes to information published in this document, including without limitation specifications and product descriptions, at any time and without notice. This document supersedes and replaces all information supplied prior to the publication hereof.

**Suitability for use** — Nexperia products are not designed, authorized or warranted to be suitable for use in life support, life-critical or safety-critical systems or equipment, nor in applications where failure or malfunction of an Nexperia product can reasonably be expected to result in personal

injury, death or severe property or environmental damage. Nexperia and its suppliers accept no liability for inclusion and/or use of Nexperia products in such equipment or applications and therefore such inclusion and/or use is at the customer's own risk.

**Quick reference data** — The Quick reference data is an extract of the product data given in the Limiting values and Characteristics sections of this document, and as such is not complete, exhaustive or legally binding.

**Applications** — Applications that are described herein for any of these products are for illustrative purposes only. Nexperia makes no representation or warranty that such applications will be suitable for the specified use without further testing or modification.

Customers are responsible for the design and operation of their applications and products using Nexperia products, and Nexperia accepts no liability for any assistance with applications or customer product design. It is customer's sole responsibility to determine whether the Nexperia product is suitable and fit for the customer's applications and products planned, as well as for the planned application and use of customer's third party customer(s). Customers should provide appropriate design and operating safeguards to minimize the risks associated with their applications and products.

Nexperia does not accept any liability related to any default, damage, costs or problem which is based on any weakness or default in the customer's applications or products, or the application or use by customer's third party customer(s). Customer is responsible for doing all necessary testing for the customer's applications and products using Nexperia products in order to avoid a default of the applications and the products or of the application or use by customer's third party customer(s). Nexperia does not accept any liability in this respect.

**Limiting values** — Stress above one or more limiting values (as defined in the Absolute Maximum Ratings System of IEC 60134) will cause permanent damage to the device. Limiting values are stress ratings only and (proper) operation of the device at these or any other conditions above those given in the Recommended operating conditions section (if present) or the Characteristics sections of this document is not warranted. Constant or repeated exposure to limiting values will permanently and irreversibly affect the quality and reliability of the device.

**Terms and conditions of commercial sale** — Nexperia products are sold subject to the general terms and conditions of commercial sale, as published at <http://www.nexperia.com/profile/terms>, unless otherwise agreed in a valid written individual agreement. In case an individual agreement is concluded only the terms and conditions of the respective agreement shall apply. Nexperia hereby expressly objects to applying the customer's general terms and conditions with regard to the purchase of Nexperia products by customer.

**No offer to sell or license** — Nothing in this document may be interpreted or construed as an offer to sell products that is open for acceptance or the grant, conveyance or implication of any license under any copyrights, patents or other industrial or intellectual property rights.

**Export control** — This document as well as the item(s) described herein may be subject to export control regulations. Export might require a prior authorization from competent authorities.

**Non-automotive qualified products** — Unless this data sheet expressly states that this specific Nexperia product is automotive qualified, the product is not suitable for automotive use. It is neither qualified nor tested in accordance with automotive testing or application requirements. Nexperia accepts no liability for inclusion and/or use of non-automotive qualified products in automotive equipment or applications.

In the event that customer uses the product for design-in and use in automotive applications to automotive specifications and standards, customer (a) shall use the product without Nexperia's warranty of the product for such automotive applications, use and specifications, and (b) whenever customer uses the product for automotive applications beyond Nexperia's specifications such use shall be solely at customer's own risk, and (c) customer fully indemnifies Nexperia for any liability, damages or failed product claims resulting from customer design and use of the product for automotive applications beyond Nexperia's standard warranty and Nexperia's product specifications.

**Translations** — A non-English (translated) version of a document is for reference only. The English version shall prevail in case of any discrepancy between the translated and English versions.

### Trademarks

Notice: All referenced brands, product names, service names and trademarks are the property of their respective owners.

## Contents

---

1. General description.....	1
2. Features and benefits.....	1
3. Applications.....	1
4. Quick reference data.....	1
5. Pinning information.....	2
6. Ordering information.....	2
7. Marking.....	3
8. Limiting values.....	4
9. Thermal characteristics.....	4
10. Characteristics.....	4
11. Package outline.....	10
12. Soldering.....	11
13. Revision history.....	12
14. Legal information.....	13

---

© Nexperia B.V. 2022. All rights reserved

For more information, please visit: <http://www.nexperia.com>

For sales office addresses, please send an email to: [salesaddresses@nexperia.com](mailto:salesaddresses@nexperia.com)

Date of release: 1 January 2023

---

单击下面可查看定价，库存，交付和生命周期等信息

[>>Nexperia\(安世\)](#)