



# PHB20N06T

## N-channel TrenchMOS standard level FET

Rev. 02 — 25 November 2009

Product data sheet

## 1. Product profile

### 1.1 General description

Standard level N-channel enhancement mode Field-Effect Transistor (FET) in a plastic package using TrenchMOS technology. This product is designed and qualified for use in computing, communications, consumer and industrial applications only.

### 1.2 Features and benefits

- Low conduction losses due to low on-state resistance
- Suitable for high frequency applications due to fast switching characteristics

### 1.3 Applications

- DC-to-DC convertors
- Switched-mode power supplies

### 1.4 Quick reference data

Table 1. Quick reference

Symbol	Parameter	Conditions	Min	Typ	Max	Unit
$V_{DS}$	drain-source voltage	$T_j \geq 25\text{ °C}; T_j \leq 175\text{ °C}$	-	-	55	V
$I_D$	drain current	$T_{mb} = 25\text{ °C}; V_{GS} = 10\text{ V};$ see <a href="#">Figure 3</a> and <a href="#">1</a>	-	-	20.3	A
$P_{tot}$	total power dissipation	$T_{mb} = 25\text{ °C};$ see <a href="#">Figure 2</a>	-	-	62	W
<b>Dynamic characteristics</b>						
$Q_{GD}$	gate-drain charge	$V_{GS} = 10\text{ V}; I_D = 25\text{ A};$ $V_{DS} = 44\text{ V}; T_j = 25\text{ °C};$ see <a href="#">Figure 13</a>	-	6	-	nC
<b>Static characteristics</b>						
$R_{DS(on)}$	drain-source on-state resistance	$V_{GS} = 10\text{ V}; I_D = 10\text{ A};$ $T_j = 175\text{ °C};$ see <a href="#">Figure 11</a> and <a href="#">12</a>	-	-	150	m $\Omega$
		$V_{GS} = 10\text{ V}; I_D = 10\text{ A};$ $T_j = 25\text{ °C};$ see <a href="#">Figure 11</a> and <a href="#">12</a>	-	64	75	m $\Omega$

## 2. Pinning information

**Table 2. Pinning information**

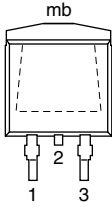
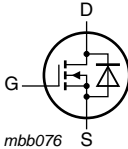
Pin	Symbol	Description	Simplified outline	Graphic symbol
1	G	gate		
2	D	drain <a href="#">[1]</a>		
3	S	source		
mb	D	mounting base; connected to drain		

**SOT404 (D2PAK)**

[1] It is not possible to make a connection to pin 2.

## 3. Ordering information

**Table 3. Ordering information**

Type number	Package		Version
	Name	Description	
PHB20N06T	D2PAK	plastic single-ended surface-mounted package (D2PAK); 3 leads (one lead cropped)	SOT404

## 4. Limiting values

**Table 4. Limiting values**

In accordance with the Absolute Maximum Rating System (IEC 60134).

Symbol	Parameter	Conditions	Min	Max	Unit
$V_{DS}$	drain-source voltage	$T_j \geq 25\text{ °C}$ ; $T_j \leq 175\text{ °C}$	-	55	V
$V_{DGR}$	drain-gate voltage	$R_{GS} = 20\text{ k}\Omega$	-	55	V
$V_{GS}$	gate-source voltage		-20	20	V
$I_D$	drain current	$V_{GS} = 10\text{ V}$ ; $T_{mb} = 100\text{ °C}$ ; see <a href="#">Figure 1</a>	-	14.3	A
		$V_{GS} = 10\text{ V}$ ; $T_{mb} = 25\text{ °C}$ ; see <a href="#">Figure 3</a> and <a href="#">1</a>	-	20.3	A
$I_{DM}$	peak drain current	$t_p \leq 10\text{ }\mu\text{s}$ ; pulsed; $T_{mb} = 25\text{ °C}$ ; see <a href="#">Figure 3</a>	-	81	A
$P_{tot}$	total power dissipation	$T_{mb} = 25\text{ °C}$ ; see <a href="#">Figure 2</a>	-	62	W
$T_{stg}$	storage temperature		-55	175	°C
$T_j$	junction temperature		-55	175	°C
<b>Source-drain diode</b>					
$I_S$	source current	$T_{mb} = 25\text{ °C}$	-	20.3	A
$I_{SM}$	peak source current	$t_p \leq 10\text{ }\mu\text{s}$ ; pulsed; $T_{mb} = 25\text{ °C}$	-	81	A
<b>Avalanche ruggedness</b>					
$E_{DS(AL)S}$	non-repetitive drain-source avalanche energy	$V_{GS} = 10\text{ V}$ ; $T_{j(\text{init})} = 25\text{ °C}$ ; $I_D = 11\text{ A}$ ; $V_{sup} \leq 55\text{ V}$ ; $R_{GS} = 50\text{ }\Omega$ ; unclamped	-	30.3	mJ

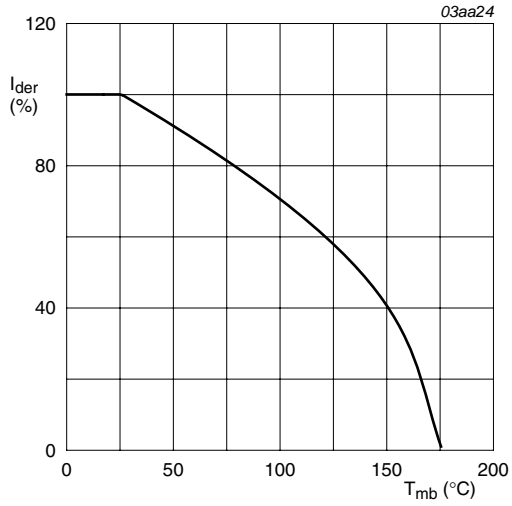

$$I_{der} = \frac{I_D}{I_{D(25^\circ\text{C})}} \times 100\%$$

Fig 1. Normalized continuous drain current as a function of mounting base temperature

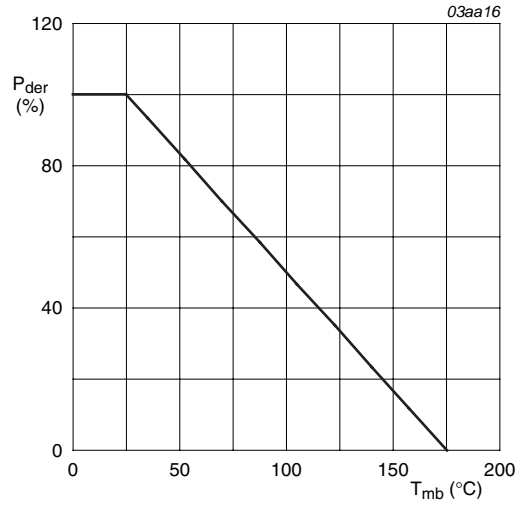

$$P_{der} = \frac{P_{tot}}{P_{tot(25^\circ\text{C})}} \times 100\%$$

Fig 2. Normalized total power dissipation as a function of mounting base temperature

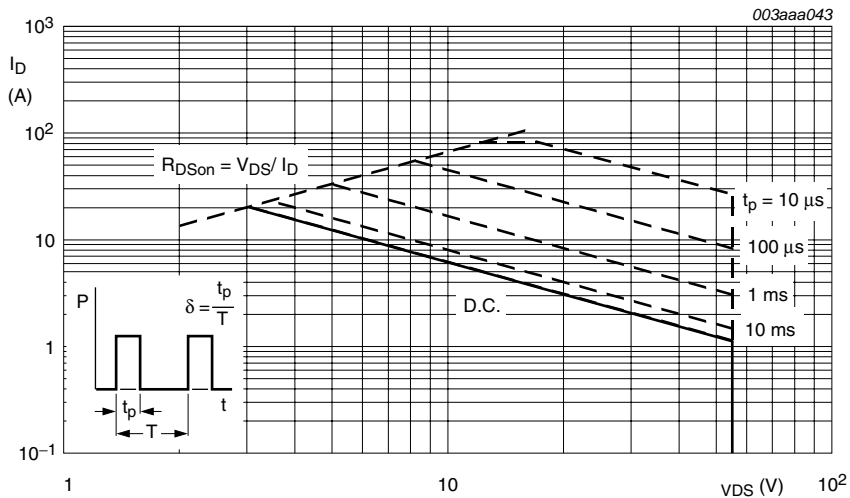

$T_{mb} = 25^\circ\text{C}; I_{DM}$  is single pulse

Fig 3. Safe operating area; continuous and peak drain currents as a function of drain-source voltage

### 5. Thermal characteristics

Table 5. Thermal characteristics

Symbol	Parameter	Conditions	Min	Typ	Max	Unit
$R_{th(j-mb)}$	thermal resistance from junction to mounting base	see <a href="#">Figure 4</a>	-	-	2.4	K/W
$R_{th(j-a)}$	thermal resistance from junction to ambient	mounted on a printed-circuit board; minimum footprint	-	50	-	K/W

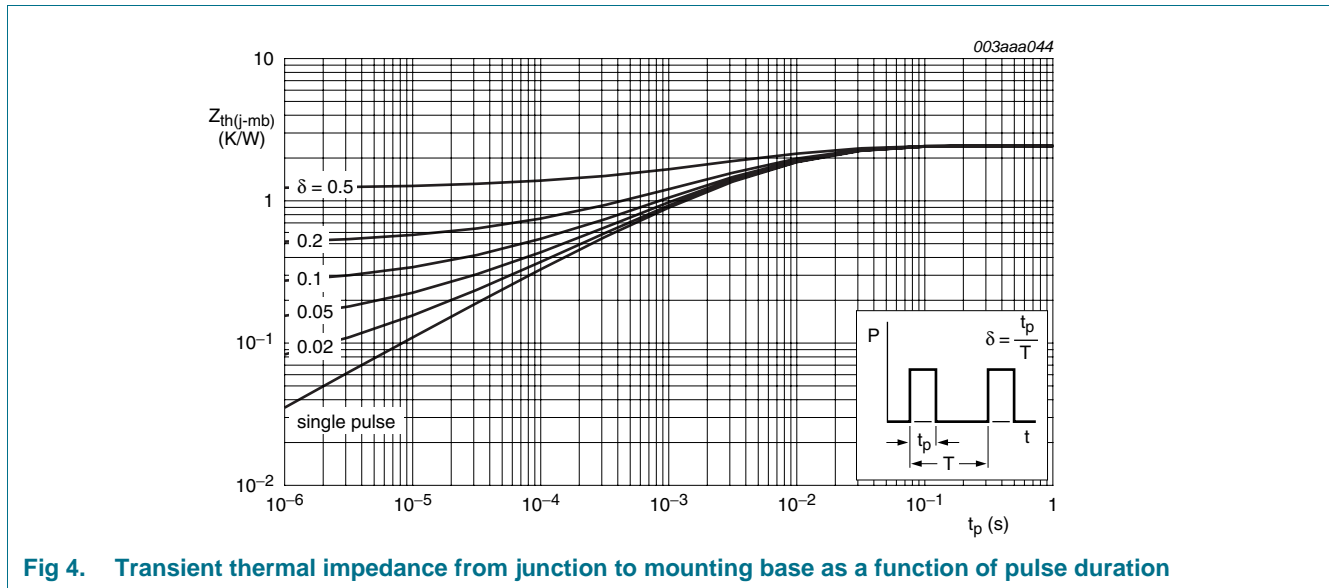
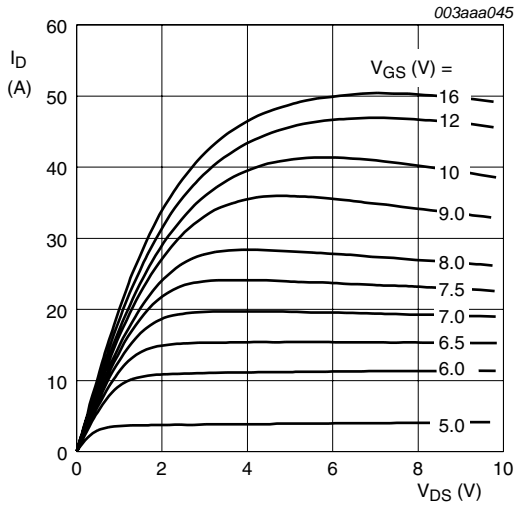

Fig 4. Transient thermal impedance from junction to mounting base as a function of pulse duration

## 6. Characteristics

**Table 6. Characteristics**

Symbol	Parameter	Conditions	Min	Typ	Max	Unit
<b>Static characteristics</b>						
$V_{(BR)DSS}$	drain-source breakdown voltage	$I_D = 0.25 \text{ mA}; V_{GS} = 0 \text{ V}; T_j = -55 \text{ }^\circ\text{C}$	50	-	-	V
		$I_D = 0.25 \text{ mA}; V_{GS} = 0 \text{ V}; T_j = 25 \text{ }^\circ\text{C}$	55	-	-	V
$V_{GS(th)}$	gate-source threshold voltage	$I_D = 1 \text{ mA}; V_{DS} = V_{GS}; T_j = 175 \text{ }^\circ\text{C};$ see <a href="#">Figure 10</a>	1	-	-	V
		$I_D = 1 \text{ mA}; V_{DS} = V_{GS}; T_j = -55 \text{ }^\circ\text{C};$ see <a href="#">Figure 10</a>	-	-	4.4	V
		$I_D = 1 \text{ mA}; V_{DS} = V_{GS}; T_j = 25 \text{ }^\circ\text{C};$ see <a href="#">Figure 10</a>	2	3	4	V
$I_{DSS}$	drain leakage current	$V_{DS} = 55 \text{ V}; V_{GS} = 0 \text{ V}; T_j = 25 \text{ }^\circ\text{C}$	-	0.05	10	$\mu\text{A}$
		$V_{DS} = 55 \text{ V}; V_{GS} = 0 \text{ V}; T_j = 175 \text{ }^\circ\text{C}$	-	-	500	$\mu\text{A}$
$I_{GSS}$	gate leakage current	$V_{GS} = 20 \text{ V}; V_{DS} = 0 \text{ V}; T_j = 25 \text{ }^\circ\text{C}$	-	2	100	nA
		$V_{GS} = -20 \text{ V}; V_{DS} = 0 \text{ V}; T_j = 25 \text{ }^\circ\text{C}$	-	2	100	nA
$R_{DS(on)}$	drain-source on-state resistance	$V_{GS} = 10 \text{ V}; I_D = 10 \text{ A}; T_j = 175 \text{ }^\circ\text{C};$ see <a href="#">Figure 11</a> and <a href="#">12</a>	-	-	150	m $\Omega$
		$V_{GS} = 10 \text{ V}; I_D = 10 \text{ A}; T_j = 25 \text{ }^\circ\text{C};$ see <a href="#">Figure 11</a> and <a href="#">12</a>	-	64	75	m $\Omega$
<b>Dynamic characteristics</b>						
$Q_{G(tot)}$	total gate charge	$I_D = 25 \text{ A}; V_{DS} = 44 \text{ V}; V_{GS} = 10 \text{ V};$ $T_j = 25 \text{ }^\circ\text{C};$ see <a href="#">Figure 13</a>	-	11	-	nC
$Q_{GS}$	gate-source charge		-	3	-	nC
$Q_{GD}$	gate-drain charge		-	6	-	nC
$C_{iss}$	input capacitance	$V_{DS} = 25 \text{ V}; V_{GS} = 0 \text{ V}; f = 1 \text{ MHz};$ $T_j = 25 \text{ }^\circ\text{C};$ see <a href="#">Figure 14</a>	-	320	483	pF
$C_{oss}$	output capacitance		-	92	113	pF
$C_{rss}$	reverse transfer capacitance		-	64	90	pF
$t_{d(on)}$	turn-on delay time	$V_{DS} = 30 \text{ V}; R_L = 1.2 \text{ } \Omega; V_{GS} = 10 \text{ V};$ $R_{G(ext)} = 10 \text{ } \Omega; T_j = 25 \text{ }^\circ\text{C}$	-	10	-	ns
$t_r$	rise time		-	50	-	ns
$t_{d(off)}$	turn-off delay time		-	70	-	ns
$t_f$	fall time		-	40	-	ns
$L_D$	internal drain inductance	from drain lead 6 mm from package to centre of die; $T_j = 25 \text{ }^\circ\text{C}$	-	4.5	-	nH
		from upper edge of drain mounting base to centre of die; $T_j = 25 \text{ }^\circ\text{C}$	-	2.5	-	nH
$L_S$	internal source inductance	from source lead to source bond pad; $T_j = 25 \text{ }^\circ\text{C}$	-	7.5	-	nH
<b>Source-drain diode</b>						
$V_{SD}$	source-drain voltage	$I_S = 25 \text{ A}; V_{GS} = 0 \text{ V}; T_j = 25 \text{ }^\circ\text{C};$ see <a href="#">Figure 15</a>	-	0.85	1.2	V
$t_{rr}$	reverse recovery time	$I_S = 20 \text{ A}; di_S/dt = -100 \text{ A}/\mu\text{s}; V_{GS} = -10 \text{ V};$ $V_{DS} = 30 \text{ V}; T_j = 25 \text{ }^\circ\text{C}$	-	32	-	ns
$Q_r$	recovered charge		-	120	-	nC



$T_j = 25^\circ\text{C}; t_p = 300\mu\text{s}$

Fig 5. Output characteristics: drain current as a function of drain-source voltage; typical values

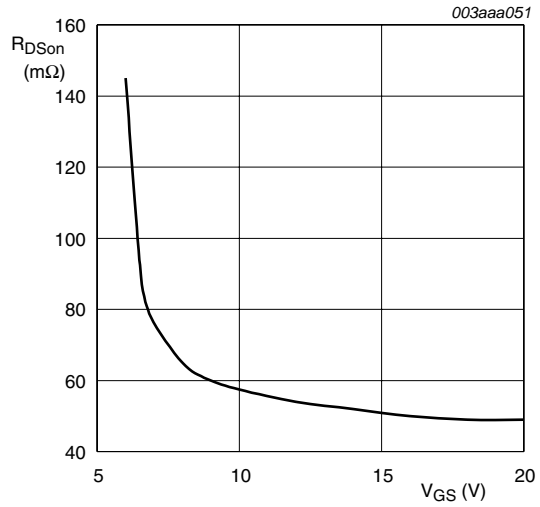

$T_j = 25^\circ\text{C}; I_D = 25\text{A}$

Fig 6. Drain-source on-state resistance as a function of gate-source voltage; typical values

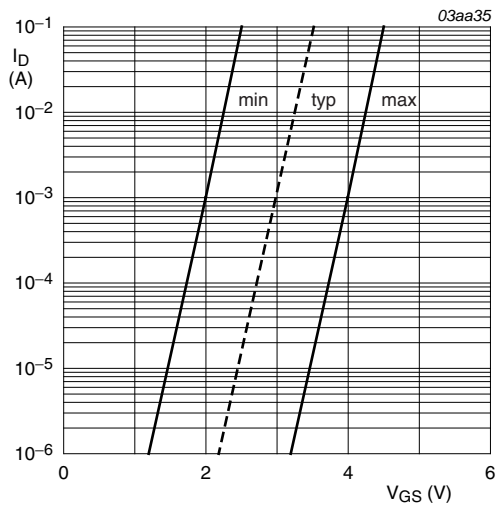

$T_j = 25^\circ\text{C}; V_{DS} = 5\text{V}$

Fig 7. Sub-threshold drain current as a function of gate-source voltage

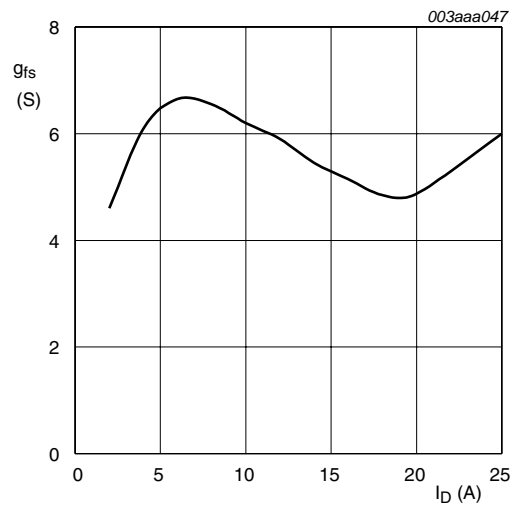

$T_j = 25^\circ\text{C}; V_{DS} = 25\text{V}$

Fig 8. Forward transconductance as a function of drain current; typical values

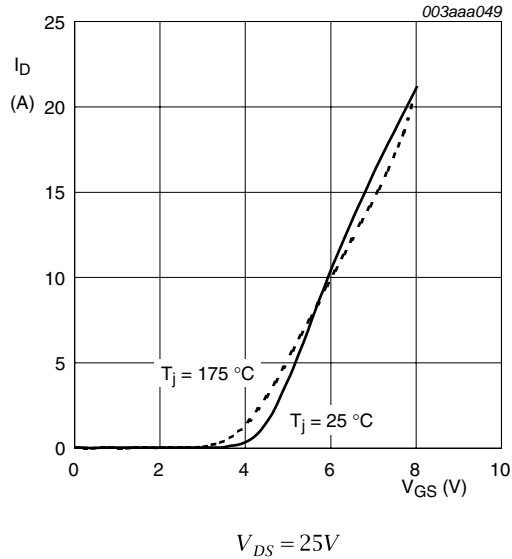

Fig 9. Transfer characteristics: drain current as a function of gate-source voltage; typical values

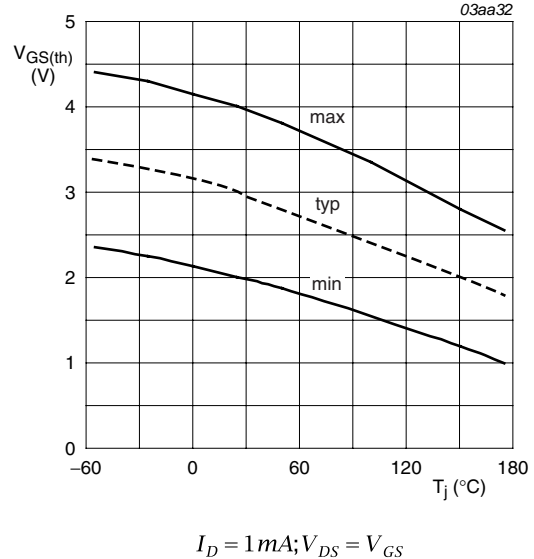

Fig 10. Gate-source threshold voltage as a function of junction temperature

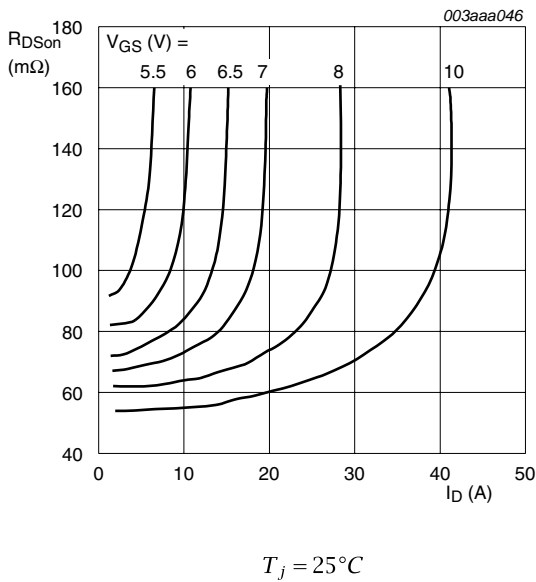

Fig 11. Drain-source on-state resistance as a function of drain current; typical values

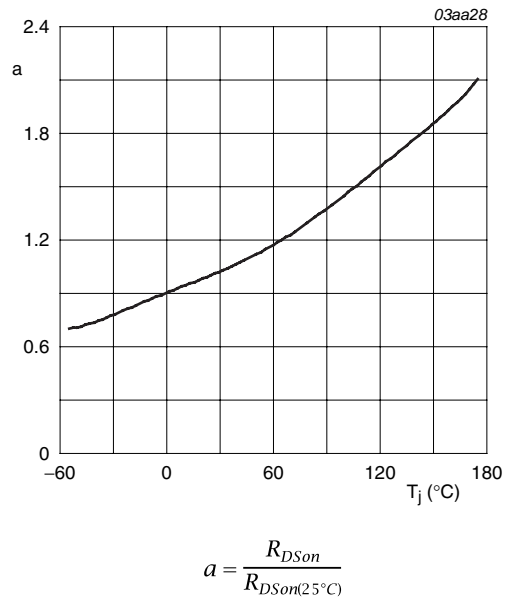
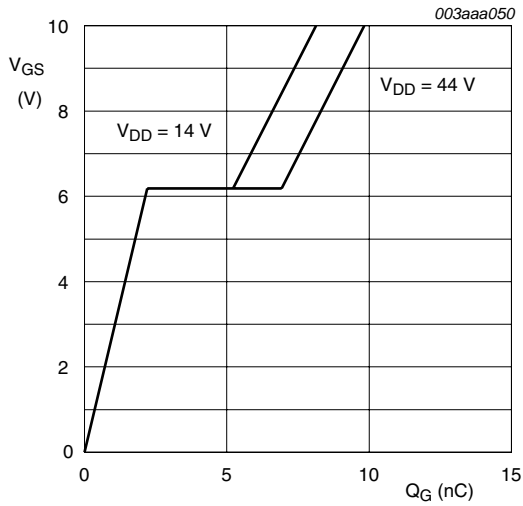
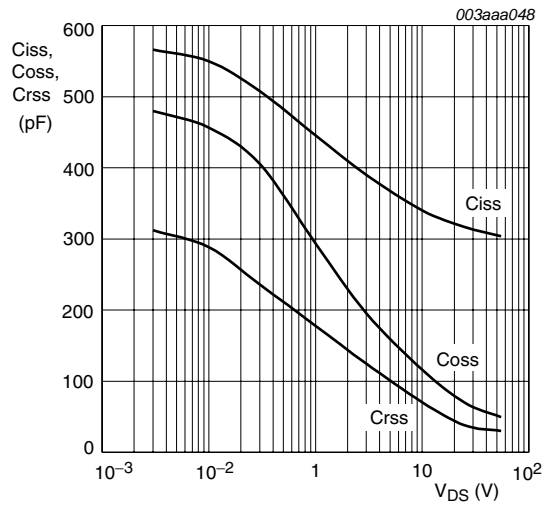

Fig 12. Normalized drain-source on-state resistance factor as a function of junction temperature



$T_j = 25^\circ\text{C}; I_D = 25\text{A}$

Fig 13. Gate-source voltage as a function of gate charge; typical values



$V_{GS} = 0\text{V}; f = 1\text{MHz}$

Fig 14. Input, output and reverse transfer capacitances as a function of drain-source voltage; typical values

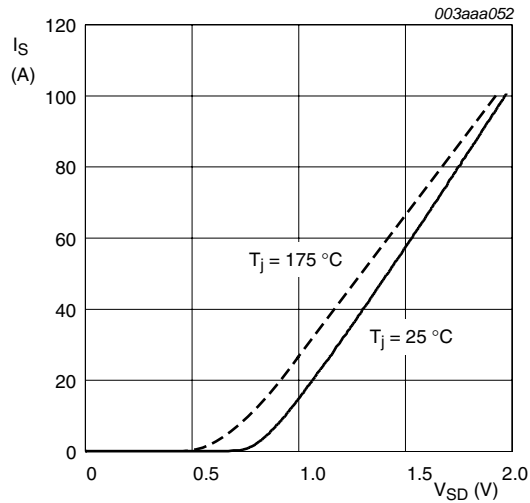

$V_{GS} = 0\text{V}$

Fig 15. Source current as a function of source-drain voltage; typical values



7. Package outline

Plastic single-ended surface-mounted package (D2PAK); 3 leads (one lead cropped)

SOT404

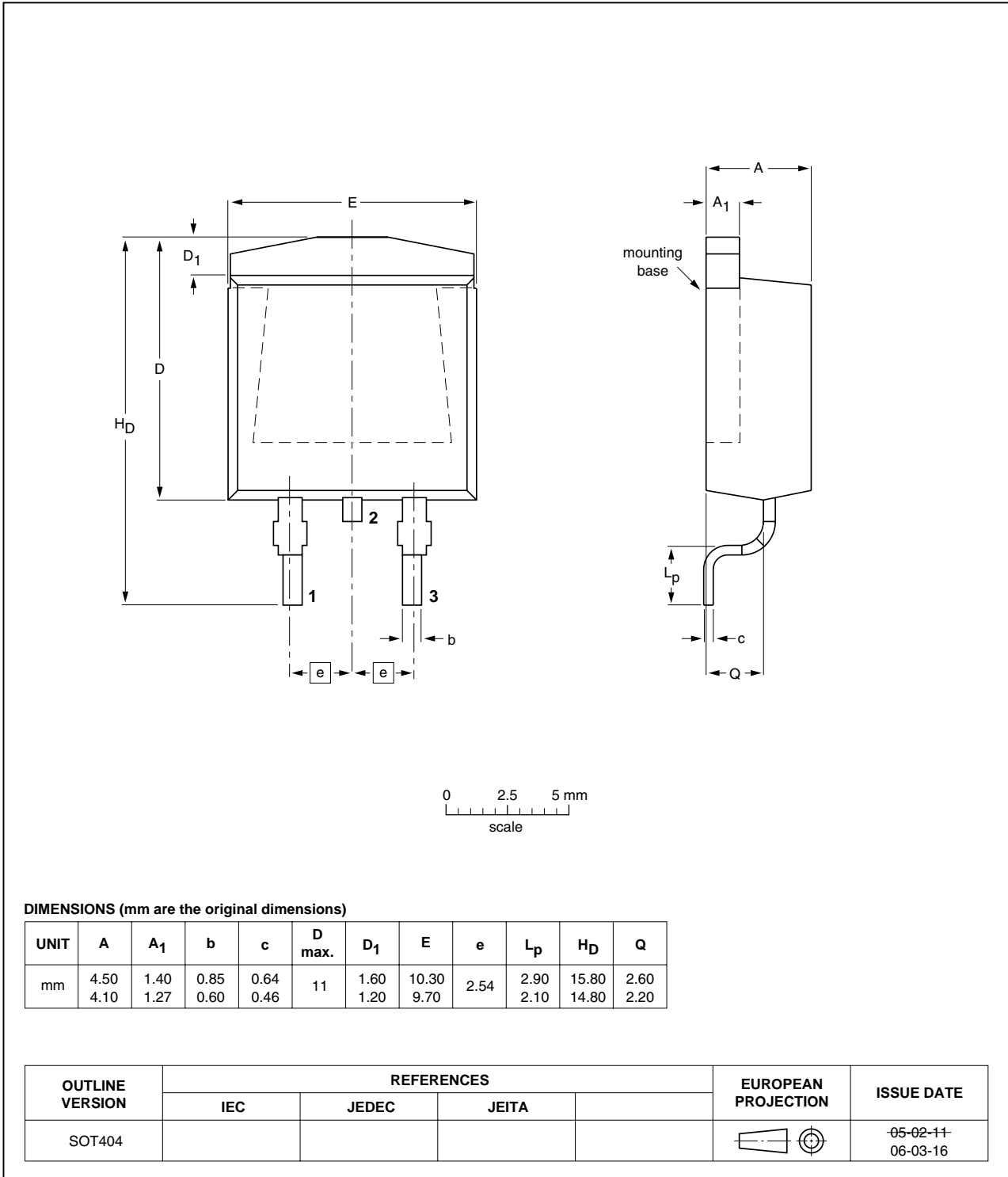

Fig 16. Package outline SOT404 (D2PAK)

## 8. Revision history

Table 7. Revision history

Document ID	Release date	Data sheet status	Change notice	Supersedes
PHB20N06T_2	20091125	Product data sheet	-	PHP20N06T_PHB20N06T-01
Modifications:				
				<ul style="list-style-type: none"><li>• The format of this data sheet has been redesigned to comply with the new identity guidelines of NXP Semiconductors.</li><li>• Legal texts have been adapted to the new company name where appropriate.</li><li>• Typenumber PHB20N06T separated from data sheet PHP20N06T_PHB20N06T-01.</li></ul>
PHP20N06T_PHB20N06T-01	20010222	Product specification	-	-

## 9. Legal information

### 9.1 Data sheet status

Document status <sup>[1][2]</sup>	Product status <sup>[3]</sup>	Definition
Objective [short] data sheet	Development	This document contains data from the objective specification for product development.
Preliminary [short] data sheet	Qualification	This document contains data from the preliminary specification.
Product [short] data sheet	Production	This document contains the product specification.

[1] Please consult the most recently issued document before initiating or completing a design.

[2] The term 'short data sheet' is explained in section "Definitions".

[3] The product status of device(s) described in this document may have changed since this document was published and may differ in case of multiple devices. The latest product status information is available on the Internet at URL <http://www.nexperia.com>.

### 9.2 Definitions

**Draft**— The document is a draft version only. The content is still under internal review and subject to formal approval, which may result in modifications or additions. Nexperia does not give any representations or warranties as to the accuracy or completeness of information included herein and shall have no liability for the consequences of use of such information.

**Short data sheet**— A short data sheet is an extract from a full data sheet with the same product type number(s) and title. A short data sheet is intended for quick reference only and should not be relied upon to contain detailed and full information. For detailed and full information see the relevant full data sheet, which is available on request via the local Nexperia sales office. In case of any inconsistency or conflict with the short data sheet, the full data sheet shall prevail.

### 9.3 Disclaimers

**General**— Information in this document is believed to be accurate and reliable. However, Nexperia does not give any representations or warranties, expressed or implied, as to the accuracy or completeness of such information and shall have no liability for the consequences of use of such information.

**Right to make changes**— Nexperia reserves the right to make changes to information published in this document, including without limitation specifications and product descriptions, at any time and without notice. This document supersedes and replaces all information supplied prior to the publication hereof.

**Suitability for use**— Nexperia products are not designed, authorized or warranted to be suitable for use in medical, military, aircraft, space or life support equipment, nor in applications where failure or malfunction of a Nexperia product can reasonably be expected to result in personal injury, death or severe property or environmental damage. Nexperia accepts no liability for inclusion and/or use of Nexperia products in such equipment or applications and therefore such inclusion and/or use is at the customer's own risk.

**Applications**— Applications that are described herein for any of these products are for illustrative purposes only. Nexperia makes no representation or warranty that such applications will be suitable for the specified use without further testing or modification.

**Quick reference data**— The Quick reference data is an extract of the product data given in the Limiting values and Characteristics sections of this document, and as such is not complete, exhaustive or legally binding.

**Limiting values**— Stress above one or more limiting values (as defined in the Absolute Maximum Ratings System of IEC 60134) may cause permanent damage to the device. Limiting values are stress ratings only and operation of the device at these or any other conditions above those given in the Characteristics sections of this document is not implied. Exposure to limiting values for extended periods may affect device reliability.

**Terms and conditions of sale**— Nexperia products are sold subject to the general terms and conditions of commercial sale, as published at <http://www.nexperia.com/profile/terms>, including those pertaining to warranty, intellectual property rights infringement and limitation of liability, unless explicitly otherwise agreed to in writing by Nexperia. In case of any inconsistency or conflict between information in this document and such terms and conditions, the latter will prevail.

**No offer to sell or license**— Nothing in this document may be interpreted or construed as an offer to sell products that is open for acceptance or the grant, conveyance or implication of any license under any copyrights, patents or other industrial or intellectual property rights.

**Export control**— This document as well as the item(s) described herein may be subject to export control regulations. Export might require a prior authorization from national authorities.

### 9.4 Trademarks

Notice: All referenced brands, product names, service names and trademarks are the property of their respective owners.

## 10. Contact information

For more information, please visit: <http://www.nexperia.com>

For sales office addresses, please send an email to: [salesaddresses@nexperia.com](mailto:salesaddresses@nexperia.com)

## 11. Contents

---

<b>1</b>	<b>Product profile</b> . . . . .	<b>1</b>
1.1	General description . . . . .	1
1.2	Features and benefits . . . . .	1
1.3	Applications . . . . .	1
1.4	Quick reference data . . . . .	1
<b>2</b>	<b>Pinning information</b> . . . . .	<b>2</b>
<b>3</b>	<b>Ordering information</b> . . . . .	<b>2</b>
<b>4</b>	<b>Limiting values</b> . . . . .	<b>2</b>
<b>5</b>	<b>Thermal characteristics</b> . . . . .	<b>4</b>
<b>6</b>	<b>Characteristics</b> . . . . .	<b>5</b>
<b>7</b>	<b>Package outline</b> . . . . .	<b>9</b>
<b>8</b>	<b>Revision history</b> . . . . .	<b>10</b>
<b>9</b>	<b>Legal information</b> . . . . .	<b>11</b>
9.1	Data sheet status . . . . .	11
9.2	Definitions . . . . .	11
9.3	Disclaimers . . . . .	11
9.4	Trademarks . . . . .	11
<b>10</b>	<b>Contact information</b> . . . . .	<b>11</b>

单击下面可查看定价，库存，交付和生命周期等信息

[>>Nexperia\(安世\)](#)