



BZT52-B series

Single Zener diodes

Rev. 2 — 6 February 2024

Product data sheet

1. General description

General-purpose Zener diodes in a SOD123 small Surface-Mounted Device (SMD) plastic package.

2. Features and benefits

- Total power dissipation: $P_{\text{tot}} \leq 590 \text{ mW}$
- Wide working voltage range: nominal 2.4 V to 75 V (E24 range)
- Small plastic package suitable for surface-mounted design
- Low differential resistance
- Tight tolerance: $\pm 2 \%$

3. Applications

- General regulation functions

4. Quick reference data

Table 1. Quick reference data

Symbol	Parameter	Conditions	Min	Typ	Max	Unit
V_F	forward voltage	$I_F = 10 \text{ mA}$ [1]	-	-	0.9	V
P_{tot}	total power dissipation	$T_{\text{amb}} \leq 25 \text{ }^\circ\text{C}$ [2]	-	-	590	mW
			-	-	350	mW

[1] Pulse test: $t_p \leq 300 \text{ } \mu\text{s}$; $\delta \leq 0.02$.

[2] Device mounted on an FR4 PCB, single-sided copper, tin-plated, mounting pad for cathode 1 cm^2 .

[3] Device mounted on an FR4 Printed-Circuit Board (PCB), single-sided copper, tin-plated and standard footprint.

5. Pinning information

Table 2. Pinning

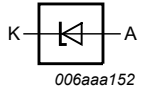
Pin	Symbol	Description	Simplified outline	Graphic symbol
1	K	cathode [1]		
2	A	anode		

[1] The marking bar indicates the cathode.

6. Ordering information

Table 3. Ordering information

Type number	Package		
	Name	Description	Version
BZT52-B2V4 to BZT52-B75 [1]	-	plastic surface-mounted package; 2 leads	SOD123

[1] The series consists of 37 types with nominal working voltages from 2.4 V to 75 V.

7. Marking

Table 4. Marking Codes

Type number	Marking code	Type number	Marking code	Type number	Marking code	Type number	Marking code
BZT52-B2V4	D7	BZT52-B6V2	DH	BZT52-B16	DT	BZT52-B43	E6
BZT52-B2V7	D8	BZT52-B6V8	DJ	BZT52-B18	DU	BZT52-B47	E7
BZT52-B3V0	D9	BZT52-B7V5	DK	BZT52-B20	DV	BZT52-B51	E8
BZT52-B3V3	DA	BZT52-B8V2	DL	BZT52-B22	DW	BZT52-B56	E9
BZT52-B3V6	DB	BZT52-B9V1	DM	BZT52-B24	DY	BZT52-B62	EA
BZT52-B3V9	DC	BZT52-B10	DN	BZT52-B27	E1	BZT52-B68	EB
BZT52-B4V3	DD	BZT52-B11	DP	BZT52-B30	E2	BZT52-B75	EC
BZT52-B4V7	DE	BZT52-B12	DQ	BZT52-B33	E3	-	-
BZT52-B5V1	DF	BZT52-B13	DR	BZT52-B36	E4	-	-
BZT52-B5V6	DG	BZT52-B15	DS	BZT52-B39	E5	-	-

8. Limiting values

Table 5. Limiting values

In accordance with the Absolute Maximum Rating System (IEC 60134).

Symbol	Parameter	Conditions	Min	Max	Unit	
I_F	continuous forward current		-	250	mA	
I_{ZSM}	non-repetitive peak reverse current		-	see characteristics tables		
P_{ZSM}	non-repetitive peak power dissipation	$t_p = 100 \mu\text{s}$; square wave; $T_{\text{amb}} = 25 \text{ }^\circ\text{C}$ prior to surge	-	40	W	
P_{tot}	total power dissipation	$T_{\text{amb}} \leq 25 \text{ }^\circ\text{C}$	[1]	-	590	mW
			[2]	-	350	mW
T_j	junction temperature		-	150	$^\circ\text{C}$	
T_{amb}	ambient temperature		-55	+150	$^\circ\text{C}$	
T_{stg}	storage temperature		-65	+150	$^\circ\text{C}$	

[1] Device mounted on an FR4 PCB, single-sided copper, tin-plated, mounting pad for cathode 1 cm^2 .

[2] Device mounted on an FR4 PCB, single-sided copper, tin-plated and standard footprint.

9. Thermal characteristics

Table 6. Thermal characteristics

Symbol	Parameter	Conditions	Min	Typ	Max	Unit	
$R_{\text{th}(j-a)}$	thermal resistance from junction to ambient	in free air	[1]	-	-	350	K/W
			[2]	-	-	210	K/W
$R_{\text{th}(j-sp)}$	thermal resistance from junction to solder pint		[3]	-	-	55	K/W

[1] Device mounted on an FR4 Printed-Circuit Board (PCB), single-sided copper, tin-plated and standard footprint.

[2] Device mounted on an FR4 PCB, single-sided copper, tin-plated, mounting pad for cathode 1 cm^2 .

[3] Soldering point of cathode tab.

10. Characteristics

Table 7. Characteristics

$T_j = 25 \text{ }^\circ\text{C}$ unless otherwise specified.

Symbol	Parameter	Conditions	Min	Typ	Max	Unit	
V_F	forward voltage	$I_F = 10 \text{ mA}$	[1]	-	-	0.9	V

[1] Pulse test: $t_p \leq 300 \mu\text{s}$; $\delta \leq 0.02$.

Table 8. Characteristics per type; BZT52-B2V4 to BZT52-B24

 $T_j = 25\text{ °C}$ unless otherwise specified.

BZT52-B	Working voltage V_Z (V);		Maximum differential resistance r_{dif} (Ω)		Reverse current I_R (μA)		Temperature coefficient S_Z (mV/K);		Diode capacitance C_d (pF)[1]	Non-repetitive peak reverse current I_{ZSM} (A)[2]
	$I_Z = 5\text{ mA}$		$I_Z = 1\text{ mA}$	$I_Z = 5\text{ mA}$			$I_Z = 5\text{ mA}$			
	Min	Max	Max	Max	Max	V_R (V)	Min	Max	Max	Max
2V4	2.35	2.45	400	85	50	1	-3.5	0.0	450	6.0
2V7	2.65	2.75	500	83	20	1	-3.5	0.0	450	6.0
3V0	2.94	3.06	500	95	10	1	-3.5	0.0	450	6.0
3V3	3.23	3.37	500	95	5	1	-3.5	0.0	450	6.0
3V6	3.53	3.67	500	95	5	1	-3.5	0.0	450	6.0
3V9	3.82	3.98	500	95	3	1	-3.5	0.0	450	6.0
4V3	4.21	4.39	500	95	3	1	-3.5	0.0	450	6.0
4V7	4.61	4.79	500	78	3	2	-3.5	0.2	300	6.0
5V1	5.00	5.20	480	60	2	2	-2.7	1.2	300	6.0
5V6	5.49	5.71	400	40	1	2	-2.0	2.5	300	6.0
6V2	6.08	6.32	150	10	3	4	0.4	3.7	200	6.0
6V8	6.66	6.94	80	8	2	4	1.2	4.5	200	6.0
7V5	7.35	7.65	80	10	1	5	2.5	5.3	150	4.0
8V2	8.04	8.36	80	10	0.7	5	3.2	6.2	150	4.0
9V1	8.92	9.28	100	10	0.5	6	3.8	7.0	150	3.0
10	9.80	10.20	70	10	0.2	7	4.5	8.0	90	3.0
11	10.80	11.20	70	10	0.1	8	5.4	9.0	85	2.5
12	11.80	12.20	90	10	0.1	8	6.0	10.0	85	2.5
13	12.70	13.30	110	10	0.1	8	7.0	11.0	80	2.5
15	14.70	15.30	110	15	0.05	10.5	9.2	13.0	75	2.0
16	15.70	16.30	170	20	0.05	11.2	10.4	14.0	75	1.5
18	17.60	18.40	170	20	0.05	12.6	12.4	16.0	70	1.5
20	19.60	20.40	220	20	0.05	14.0	14.4	18.0	60	1.5
22	21.60	22.40	220	25	0.05	15.4	16.4	20.0	60	1.25
24	23.50	24.50	220	30	0.05	16.8	18.4	22.0	55	1.25

[1] $f = 1\text{ MHz}$; $V_R = 0\text{ V}$ [2] $t_p = 100\text{ }\mu\text{s}$; $T_{amb} = 25\text{ °C}$

Table 9. Characteristics per type; BZT52-B27 to BZT52-B51

$T_j = 25\text{ °C}$ unless otherwise specified.

BZT52-B	Working voltage V_Z (V);		Maximum differential resistance r_{dif} (Ω)		Reverse current I_R (μA)		Temperature coefficient S_Z (mV/K);		Diode capacitance C_d (pF)[1]	Non-repetitive peak reverse current I_{ZSM} (A)[2]
	$I_Z = 2\text{ mA}$		$I_Z = 1\text{ mA}$	$I_Z = 5\text{ mA}$			$I_Z = 5\text{ mA}$			
	Min	Max	Max	Max	Max	V_R (V)	Min	Max	Max	Max
27	26.5	27.5	250	40	0.05	18.9	21.4	25.3	50	1.0
30	29.4	30.6	250	40	0.05	21.0	24.4	29.4	50	1.0
33	32.3	33.7	250	40	0.05	23.1	27.4	33.4	45	0.9
36	35.3	36.7	250	60	0.05	25.2	30.4	37.4	45	0.8
39	38.2	39.8	300	75	0.05	27.3	33.4	41.2	45	0.7
43	42.1	43.9	325	80	0.05	30.1	37.6	46.6	40	0.6
47	46.1	47.9	325	90	0.05	32.9	42.0	51.8	40	0.5
51	50.0	52.0	350	100	0.05	35.7	46.6	57.2	40	0.4

[1] $f = 1\text{ MHz}$; $V_R = 0\text{ V}$

[2] $t_p = 100\ \mu\text{s}$; $T_{amb} = 25\text{ °C}$

Table 10. Characteristics per type; BZT52-B56 to BZT52-B75

$T_j = 25\text{ °C}$ unless otherwise specified.

BZT52-B	Working voltage V_Z (V);		Maximum differential resistance r_{dif} (Ω)		Reverse current I_R (μA)		Temperature coefficient S_Z (mV/K);		Diode capacitance C_d (pF)[1]	Non-repetitive peak reverse current I_{ZSM} (A)[2]
	$I_Z = 2\text{ mA}$		$I_Z = 0.5\text{ mA}$	$I_Z = 2\text{ mA}$			$I_Z = 5\text{ mA}$			
	Min	Max	Max	Max	Max	V_R (V)	Min	Max	Max	Max
56	54.9	57.1	375	120	0.05	39.2	52.2	63.8	40	0.30
62	60.8	63.2	400	140	0.05	43.4	58.8	71.6	35	0.30
68	66.6	69.4	400	160	0.05	47.6	65.6	79.8	35	0.25
75	73.5	76.5	400	175	0.05	52.5	73.4	88.6	35	0.20

[1] $f = 1\text{ MHz}$; $V_R = 0\text{ V}$

[2] $t_p = 100\ \mu\text{s}$; $T_{amb} = 25\text{ °C}$

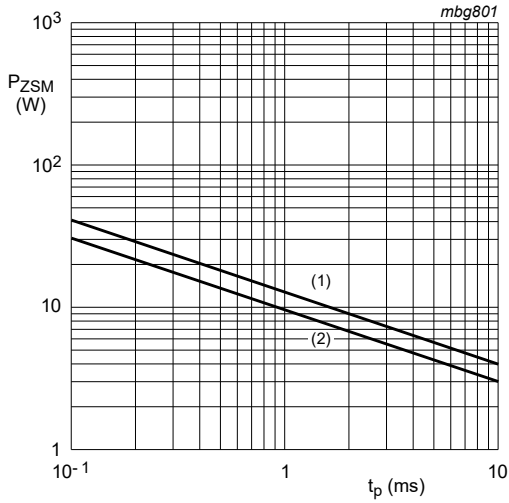

(1) $T_j = 25^\circ\text{C}$ (prior to surge)
 (2) $T_j = 150^\circ\text{C}$ (prior to surge)

Fig. 1. Non-repetitive peak reverse power dissipation as a function of pulse duration; maximum values

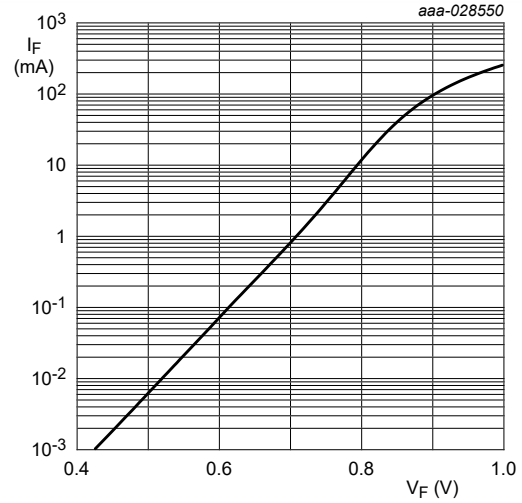

$T_j = 25^\circ\text{C}$

Fig. 2. Forward current as a function of forward voltage; typical values (BZT52-B2V4)

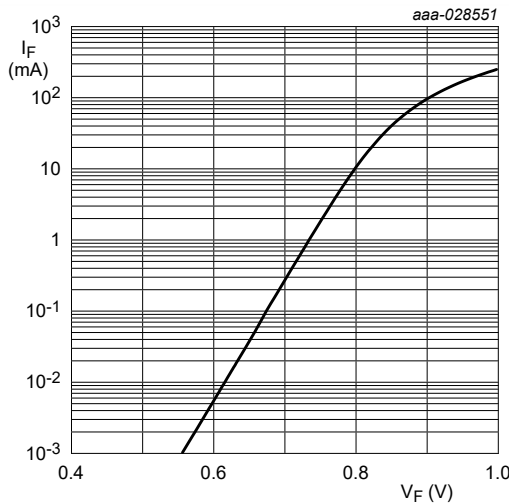

$T_j = 25^\circ\text{C}$

Fig. 3. Forward current as a function of forward voltage; typical values (BZT52-B6V8)

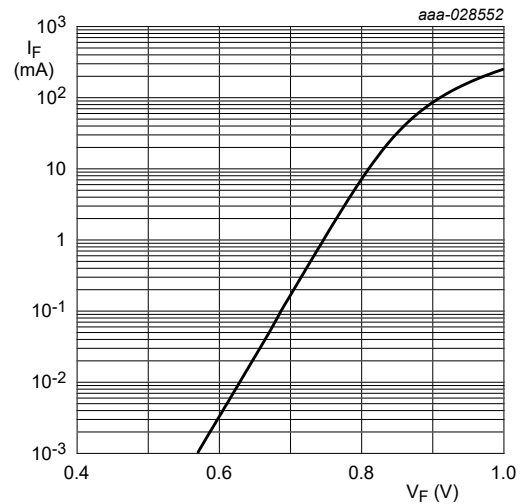

$T_j = 25^\circ\text{C}$

Fig. 4. Forward current as a function of forward voltage; typical values (BZT52-B7V5)

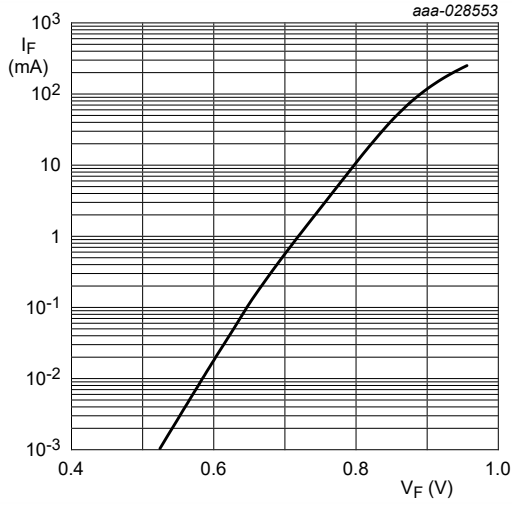

$T_j = 25\text{ °C}$

Fig. 5. Forward current as a function of forward voltage; typical values (BZT52-B75)

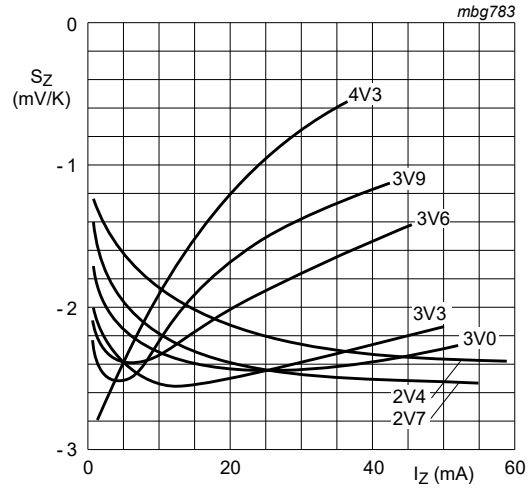

$T_j = 25\text{ °C to }150\text{ °C}$

Fig. 6. Temperature coefficient as a function of working current; typical values (BZT52-B2V4 to BZT52-B4V3)

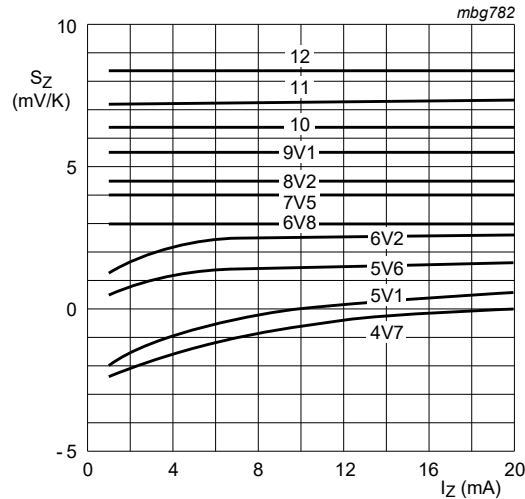

$T_j = 25\text{ °C to }150\text{ °C}$

Fig. 7. Temperature coefficient as a function of working current; typical values (BZT52-B4V7 to BZT52-B12)

11. Package outline

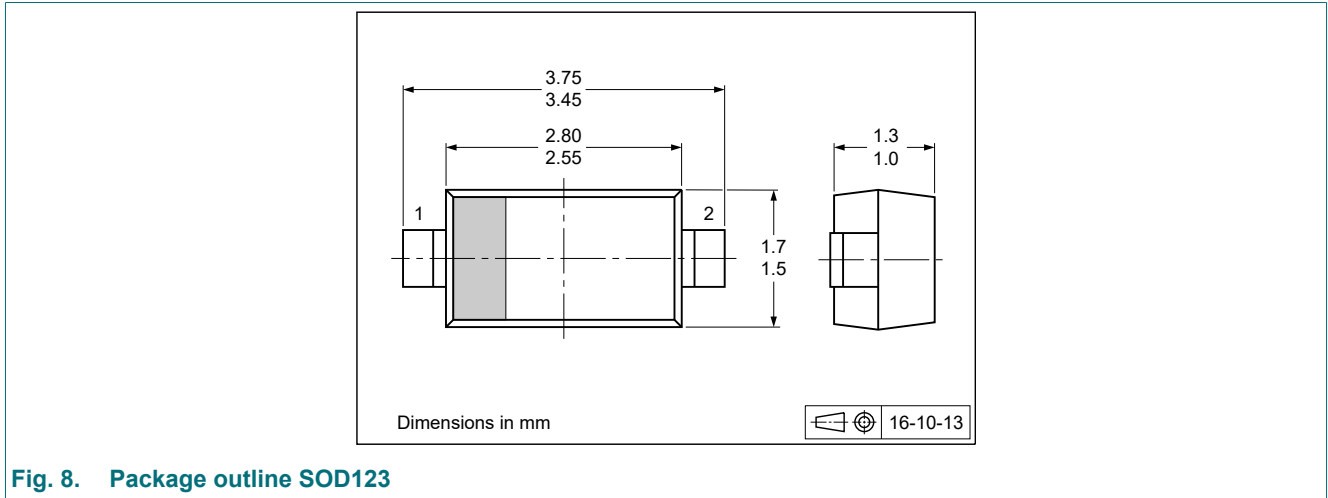

12. Soldering

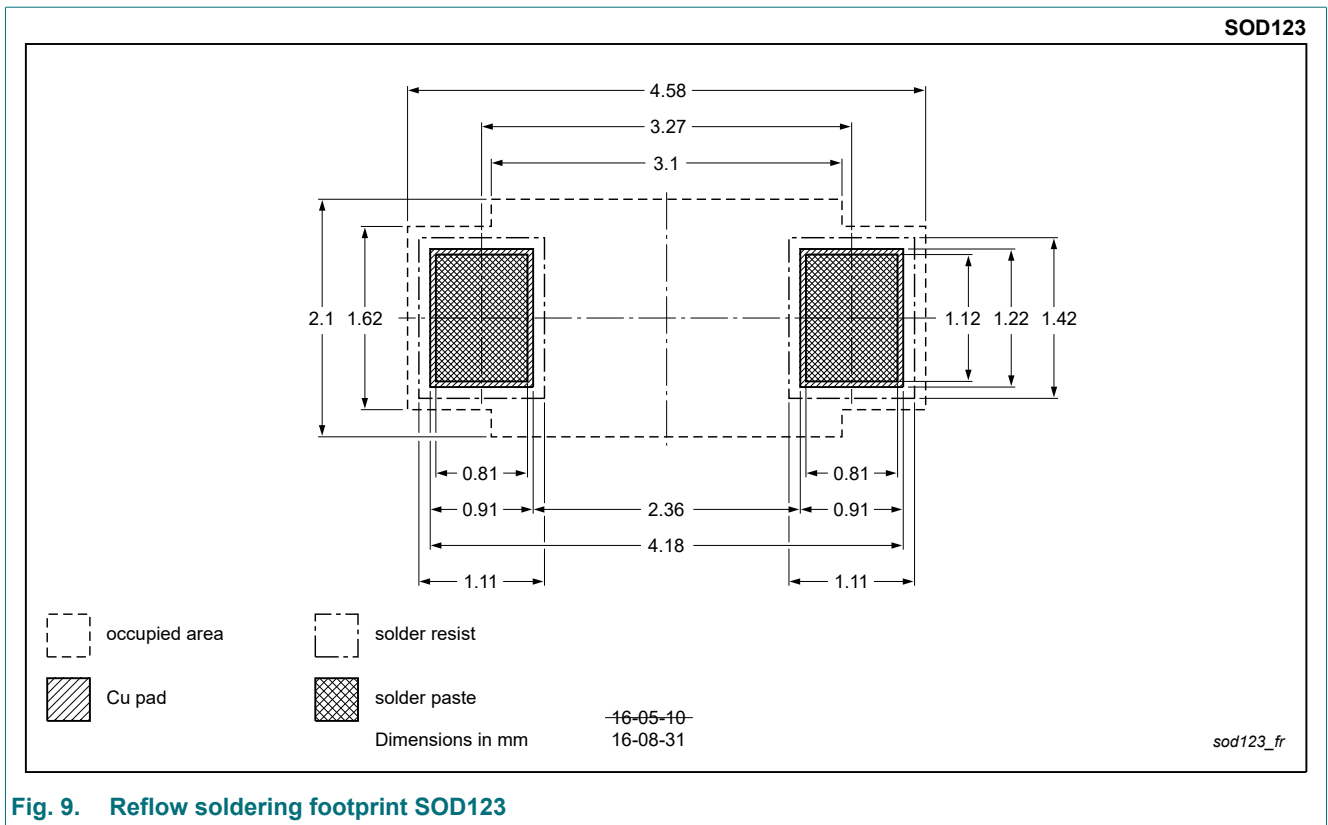

13. Revision history

Table 11. Revision history

Document ID	Release date	Data sheet status	Change notice	Supersedes
BZT52-B_SER v.2	20240206	Product data sheet	-	BZT52-B_SER v.1
Modifications:	<ul style="list-style-type: none">Product(s) changed to non-automotive qualification. Please refer to nexperia.com for automotive (-Q) product alternative(s).			
BZT52-B_SER v.1	20171220	Product data sheet	-	-

14. Legal information

Data sheet status

Document status [1][2]	Product status [3]	Definition
Objective [short] data sheet	Development	This document contains data from the objective specification for product development.
Preliminary [short] data sheet	Qualification	This document contains data from the preliminary specification.
Product [short] data sheet	Production	This document contains the product specification.

- [1] Please consult the most recently issued document before initiating or completing a design.
- [2] The term 'short data sheet' is explained in section "Definitions".
- [3] The product status of device(s) described in this document may have changed since this document was published and may differ in case of multiple devices. The latest product status information is available on the internet at <https://www.nexperia.com>.

Definitions

Draft — The document is a draft version only. The content is still under internal review and subject to formal approval, which may result in modifications or additions. Nexperia does not give any representations or warranties as to the accuracy or completeness of information included herein and shall have no liability for the consequences of use of such information.

Short data sheet — A short data sheet is an extract from a full data sheet with the same product type number(s) and title. A short data sheet is intended for quick reference only and should not be relied upon to contain detailed and full information. For detailed and full information see the relevant full data sheet, which is available on request via the local Nexperia sales office. In case of any inconsistency or conflict with the short data sheet, the full data sheet shall prevail.

Product specification — The information and data provided in a Product data sheet shall define the specification of the product as agreed between Nexperia and its customer, unless Nexperia and customer have explicitly agreed otherwise in writing. In no event however, shall an agreement be valid in which the Nexperia product is deemed to offer functions and qualities beyond those described in the Product data sheet.

Disclaimers

Limited warranty and liability — Information in this document is believed to be accurate and reliable. However, Nexperia does not give any representations or warranties, expressed or implied, as to the accuracy or completeness of such information and shall have no liability for the consequences of use of such information. Nexperia takes no responsibility for the content in this document if provided by an information source outside of Nexperia.

In no event shall Nexperia be liable for any indirect, incidental, punitive, special or consequential damages (including - without limitation - lost profits, lost savings, business interruption, costs related to the removal or replacement of any products or rework charges) whether or not such damages are based on tort (including negligence), warranty, breach of contract or any other legal theory.

Notwithstanding any damages that customer might incur for any reason whatsoever, Nexperia's aggregate and cumulative liability towards customer for the products described herein shall be limited in accordance with the Terms and conditions of commercial sale of Nexperia.

Right to make changes — Nexperia reserves the right to make changes to information published in this document, including without limitation specifications and product descriptions, at any time and without notice. This document supersedes and replaces all information supplied prior to the publication hereof.

Suitability for use — Nexperia products are not designed, authorized or warranted to be suitable for use in life support, life-critical or safety-critical systems or equipment, nor in applications where failure or malfunction of an Nexperia product can reasonably be expected to result in personal

injury, death or severe property or environmental damage. Nexperia and its suppliers accept no liability for inclusion and/or use of Nexperia products in such equipment or applications and therefore such inclusion and/or use is at the customer's own risk.

Quick reference data — The Quick reference data is an extract of the product data given in the Limiting values and Characteristics sections of this document, and as such is not complete, exhaustive or legally binding.

Applications — Applications that are described herein for any of these products are for illustrative purposes only. Nexperia makes no representation or warranty that such applications will be suitable for the specified use without further testing or modification.

Customers are responsible for the design and operation of their applications and products using Nexperia products, and Nexperia accepts no liability for any assistance with applications or customer product design. It is customer's sole responsibility to determine whether the Nexperia product is suitable and fit for the customer's applications and products planned, as well as for the planned application and use of customer's third party customer(s). Customers should provide appropriate design and operating safeguards to minimize the risks associated with their applications and products.

Nexperia does not accept any liability related to any default, damage, costs or problem which is based on any weakness or default in the customer's applications or products, or the application or use by customer's third party customer(s). Customer is responsible for doing all necessary testing for the customer's applications and products using Nexperia products in order to avoid a default of the applications and the products or of the application or use by customer's third party customer(s). Nexperia does not accept any liability in this respect.

Limiting values — Stress above one or more limiting values (as defined in the Absolute Maximum Ratings System of IEC 60134) will cause permanent damage to the device. Limiting values are stress ratings only and (proper) operation of the device at these or any other conditions above those given in the Recommended operating conditions section (if present) or the Characteristics sections of this document is not warranted. Constant or repeated exposure to limiting values will permanently and irreversibly affect the quality and reliability of the device.

Terms and conditions of commercial sale — Nexperia products are sold subject to the general terms and conditions of commercial sale, as published at <http://www.nexperia.com/profile/terms>, unless otherwise agreed in a valid written individual agreement. In case an individual agreement is concluded only the terms and conditions of the respective agreement shall apply. Nexperia hereby expressly objects to applying the customer's general terms and conditions with regard to the purchase of Nexperia products by customer.

No offer to sell or license — Nothing in this document may be interpreted or construed as an offer to sell products that is open for acceptance or the grant, conveyance or implication of any license under any copyrights, patents or other industrial or intellectual property rights.

Export control — This document as well as the item(s) described herein may be subject to export control regulations. Export might require a prior authorization from competent authorities.

Non-automotive qualified products — Unless this data sheet expressly states that this specific Nexperia product is automotive qualified, the product is not suitable for automotive use. It is neither qualified nor tested in accordance with automotive testing or application requirements. Nexperia accepts no liability for inclusion and/or use of non-automotive qualified products in automotive equipment or applications.

In the event that customer uses the product for design-in and use in automotive applications to automotive specifications and standards, customer (a) shall use the product without Nexperia's warranty of the product for such automotive applications, use and specifications, and (b) whenever customer uses the product for automotive applications beyond Nexperia's specifications such use shall be solely at customer's own risk, and (c) customer fully indemnifies Nexperia for any liability, damages or failed product claims resulting from customer design and use of the product for automotive applications beyond Nexperia's standard warranty and Nexperia's product specifications.

Translations — A non-English (translated) version of a document is for reference only. The English version shall prevail in case of any discrepancy between the translated and English versions.

Trademarks

Notice: All referenced brands, product names, service names and trademarks are the property of their respective owners.

Contents

1. General description.....	1
2. Features and benefits.....	1
3. Applications.....	1
4. Quick reference data.....	1
5. Pinning information.....	2
6. Ordering information.....	2
7. Marking.....	2
8. Limiting values.....	3
9. Thermal characteristics.....	3
10. Characteristics.....	3
11. Package outline.....	8
12. Soldering.....	8
13. Revision history.....	9
14. Legal information.....	10

© Nexperia B.V. 2024. All rights reserved

For more information, please visit: <http://www.nexperia.com>
For sales office addresses, please send an email to: salesaddresses@nexperia.com
Date of release: 6 February 2024

单击下面可查看定价，库存，交付和生命周期等信息

[>>Nexperia\(安世\)](#)