

# PDTA143E series

PNP resistor-equipped transistors;  
R1 = 4.7 k $\Omega$ , R2 = 4.7 k $\Omega$

Rev. 8 — 8 December 2011

Product data sheet

## 1. Product profile

### 1.1 General description

PNP Resistor-Equipped Transistor (RET) family in Surface-Mounted Device (SMD) plastic packages.

Table 1. Product overview

Type number	Package			NPN complement	Package configuration
	Nexperia	JEITA	JEDEC		
PDTA143EE	SOT416	SC-75	-	PDTC143EE	ultra small
PDTA143EM	SOT883	SC-101	-	PDTC143EM	leadless ultra small
PDTA143ET	SOT23	-	TO-236AB	PDTC143ET	small
PDTA143EU	SOT323	SC-70	-	PDTC143EU	very small

### 1.2 Features and benefits

- 100 mA output current capability
- Built-in bias resistors
- Simplifies circuit design
- Reduces component count
- Reduces pick and place costs
- AEC-Q101 qualified

### 1.3 Applications

- Digital applications in automotive and industrial segments
- Control of IC inputs
- Cost-saving alternative for BC847/857 series in digital applications
- Switching loads

### 1.4 Quick reference data

Table 2. Quick reference data

Symbol	Parameter	Conditions	Min	Typ	Max	Unit
V <sub>CEO</sub>	collector-emitter voltage	open base	-	-	-50	V
I <sub>O</sub>	output current		-	-	-100	mA
R1	bias resistor 1 (input)		3.3	4.7	6.1	k $\Omega$
R2/R1	bias resistor ratio		0.8	1	1.2	

nexperia

## 2. Pinning information

Table 3. Pinning

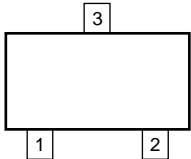
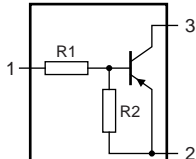
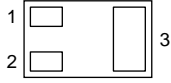
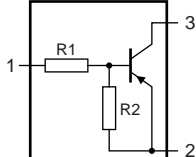
Pin	Description	Simplified outline	Graphic symbol
<b>SOT23; SOT323; SOT416</b>			
1	input (base)	 006aaa144	 sym003
2	GND (emitter)		
3	output (collector)		
<b>SOT883</b>			
1	input (base)	 Transparent top view	 sym003
2	GND (emitter)		
3	output (collector)		

## 3. Ordering information

Table 4. Ordering information

Type number	Package		
	Name	Description	Version
PDTA143EE	SC-75	plastic surface-mounted package; 3 leads	SOT416
PDTA143EM	SC-101	leadless ultra small plastic package; 3 solder lands; body 1.0 × 0.6 × 0.5 mm	SOT883
PDTA143ET	-	plastic surface-mounted package; 3 leads	SOT23
PDTA143EU	SC-70	plastic surface-mounted package; 3 leads	SOT323

## 4. Marking

Table 5. Marking codes

Type number	Marking code <sup>[1]</sup>
PDTA143EE	01
PDTA143EM	DL
PDTA143ET	*01
PDTA143EU	*01

[1] \* = placeholder for manufacturing site code

## 5. Limiting values

**Table 6. Limiting values**

*In accordance with the Absolute Maximum Rating System (IEC 60134).*

Symbol	Parameter	Conditions	Min	Max	Unit	
$V_{CBO}$	collector-base voltage	open emitter	-	-50	V	
$V_{CEO}$	collector-emitter voltage	open base	-	-50	V	
$V_{EBO}$	emitter-base voltage	open collector	-	-10	V	
$V_I$	input voltage					
	positive		-	+10	V	
	negative		-	-30	V	
$I_O$	output current		-	-100	mA	
$I_{CM}$	peak collector current	single pulse; $t_p \leq 1$ ms	-	-100	mA	
$P_{tot}$	total power dissipation	$T_{amb} \leq 25$ °C				
	PDTA143EE (SOT416)		[1][2]	-	150	mW
	PDTA143EM (SOT883)		[2][3]	-	250	mW
	PDTA143ET (SOT23)		[1]	-	250	mW
	PDTA143EU (SOT323)		[1]	-	200	mW
$T_j$	junction temperature		-	150	°C	
$T_{amb}$	ambient temperature		-65	+150	°C	
$T_{stg}$	storage temperature		-65	+150	°C	

[1] Device mounted on an FR4 Printed-Circuit Board (PCB), single-sided copper, tin-plated and standard footprint.

[2] Reflow soldering is the only recommended soldering method.

[3] Device mounted on an FR4 PCB with 70  $\mu$ m copper strip line, standard footprint.



## 6. Thermal characteristics

**Table 7. Thermal characteristics**

Symbol	Parameter	Conditions	Min	Typ	Max	Unit
R <sub>th(j-a)</sub>	thermal resistance from junction to ambient	in free air				
	PDTA143EE (SOT416)	[1][2]	-	-	830	K/W
	PDTA143EM (SOT883)	[2][3]	-	-	500	K/W
	PDTA143ET (SOT23)	[1]	-	-	500	K/W
	PDTA143EU (SOT323)	[1]	-	-	625	K/W

[1] Device mounted on an FR4 PCB, single-sided copper, tin-plated and standard footprint.

[2] Reflow soldering is the only recommended soldering method.

[3] Device mounted on an FR4 PCB with 70 μm copper strip line, standard footprint.

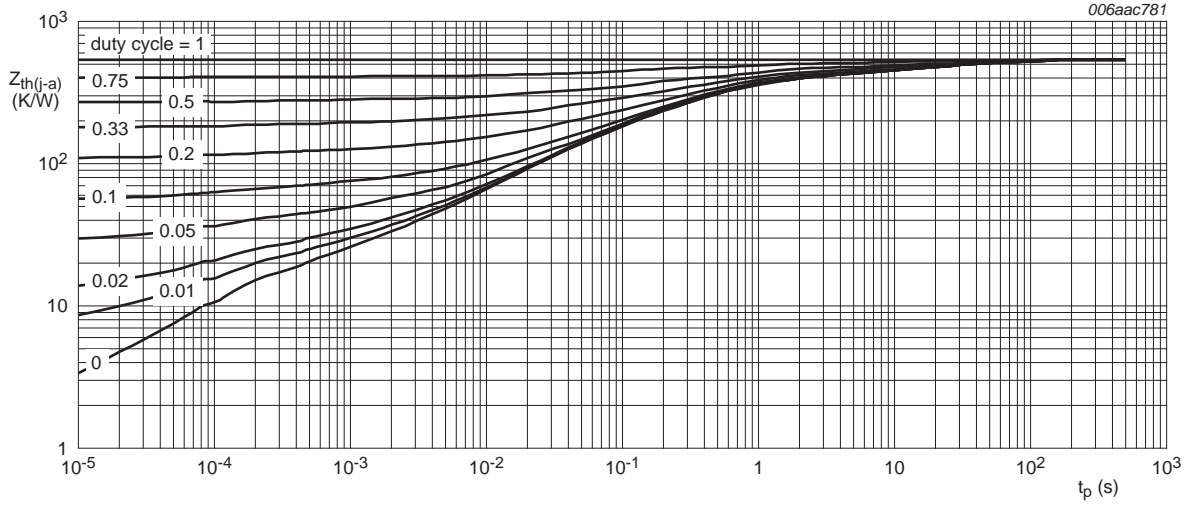

FR4 PCB, standard footprint

Fig 2. Transient thermal impedance from junction to ambient as a function of pulse duration for PDTA143EE (SOT416); typical values

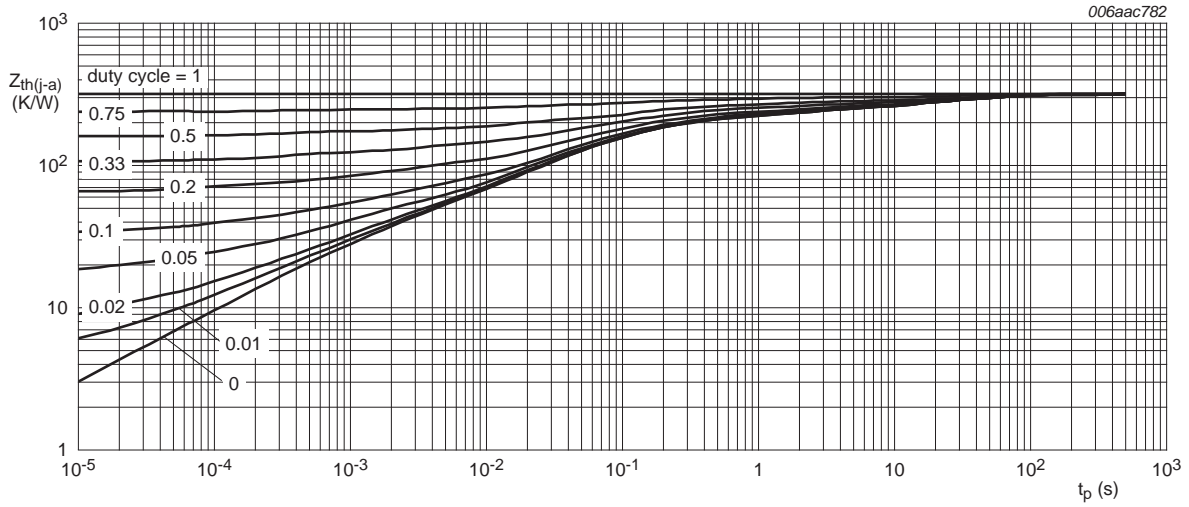

FR4 PCB, 70 μm copper strip line

Fig 3. Transient thermal impedance from junction to ambient as a function of pulse duration for PDTA143EM (SOT883); typical values



FR4 PCB, standard footprint

**Fig 4. Transient thermal impedance from junction to ambient as a function of pulse duration for PDTA143ET (SOT23); typical values**

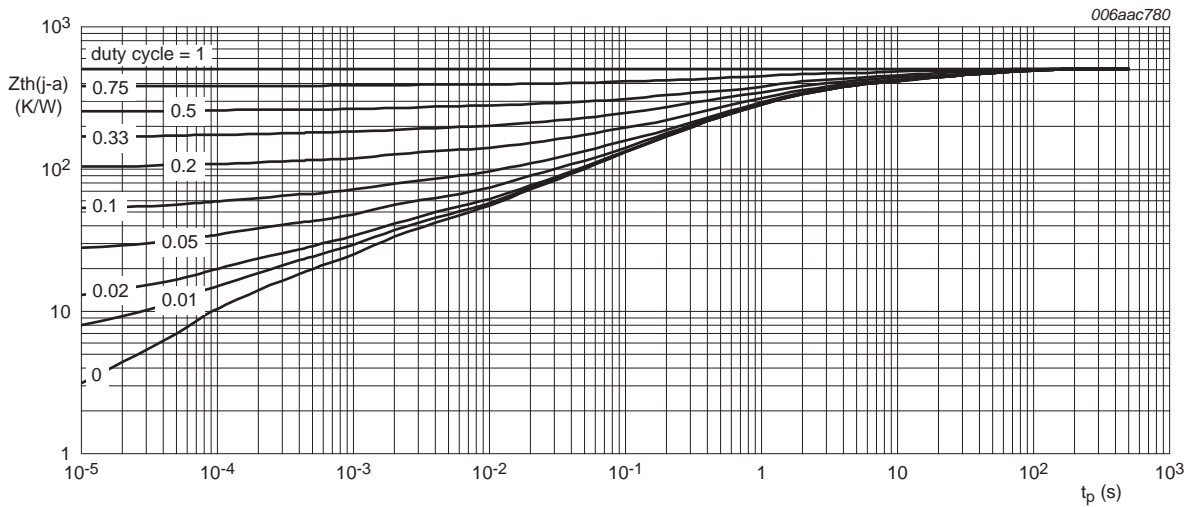

FR4 PCB, standard footprint

**Fig 5. Transient thermal impedance from junction to ambient as a function of pulse duration for PDTA143EU (SOT323); typical values**

## 7. Characteristics

**Table 8. Characteristics**

$T_{amb} = 25\text{ }^{\circ}\text{C}$  unless otherwise specified.

Symbol	Parameter	Conditions	Min	Typ	Max	Unit
$I_{CBO}$	collector-base cut-off current	$V_{CB} = -50\text{ V}$ ; $I_E = 0\text{ A}$	-	-	-100	nA
$I_{CEO}$	collector-emitter cut-off current	$V_{CE} = -30\text{ V}$ ; $I_B = 0\text{ A}$	-	-	-1	$\mu\text{A}$
		$V_{CE} = -30\text{ V}$ ; $I_B = 0\text{ A}$ ; $T_j = 150\text{ }^{\circ}\text{C}$	-	-	-5	$\mu\text{A}$
$I_{EBO}$	emitter-base cut-off current	$V_{EB} = -5\text{ V}$ ; $I_C = 0\text{ A}$	-	-	-900	$\mu\text{A}$
$h_{FE}$	DC current gain	$V_{CE} = -5\text{ V}$ ; $I_C = -10\text{ mA}$	30	-	-	
$V_{CEsat}$	collector-emitter saturation voltage	$I_C = -10\text{ mA}$ ; $I_B = -0.5\text{ mA}$	-	-	-150	mV
$V_{I(off)}$	off-state input voltage	$V_{CE} = -5\text{ V}$ ; $I_C = -100\text{ }\mu\text{A}$	-	-1.1	-0.5	V
$V_{I(on)}$	on-state input voltage	$V_{CE} = -0.3\text{ V}$ ; $I_C = -20\text{ mA}$	-2.5	-1.9	-	V
R1	bias resistor 1 (input)		3.3	4.7	6.1	k $\Omega$
R2/R1	bias resistor ratio		0.8	1	1.2	
$C_c$	collector capacitance	$V_{CB} = -10\text{ V}$ ; $I_E = i_e = 0\text{ A}$ ; $f = 1\text{ MHz}$	-	-	3	pF
$f_T$	transition frequency	$V_{CE} = -5\text{ V}$ ; $I_C = -10\text{ mA}$ ; <a href="#">[1]</a> $f = 100\text{ MHz}$	-	180	-	MHz

[1] Characteristics of built-in transistor

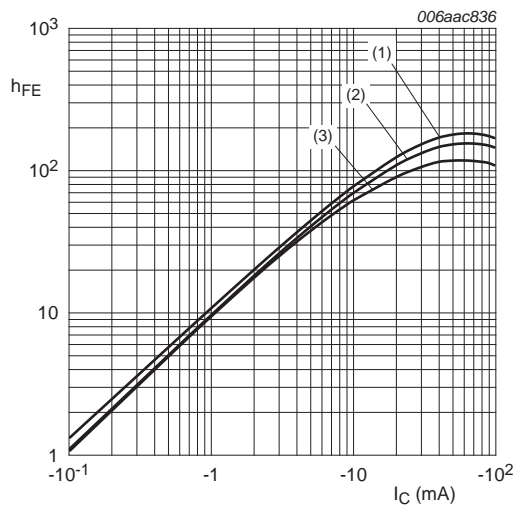

$V_{CE} = -5 \text{ V}$   
 (1)  $T_{amb} = 100 \text{ }^\circ\text{C}$   
 (2)  $T_{amb} = 25 \text{ }^\circ\text{C}$   
 (3)  $T_{amb} = -40 \text{ }^\circ\text{C}$

**Fig 6. DC current gain as a function of collector current; typical values**

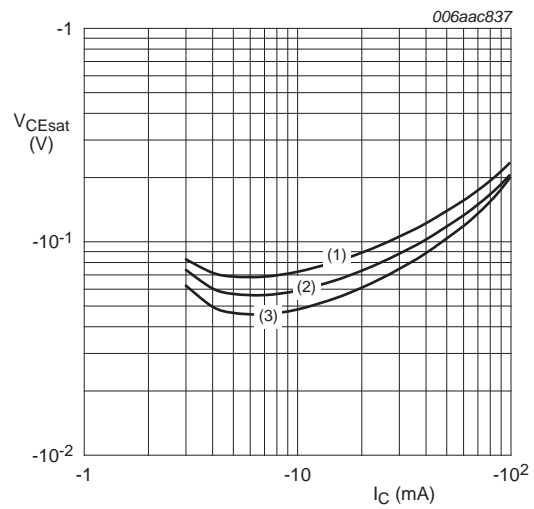

$I_C/I_B = 20$   
 (1)  $T_{amb} = 100 \text{ }^\circ\text{C}$   
 (2)  $T_{amb} = 25 \text{ }^\circ\text{C}$   
 (3)  $T_{amb} = -40 \text{ }^\circ\text{C}$

**Fig 7. Collector-emitter saturation voltage as a function of collector current; typical values**

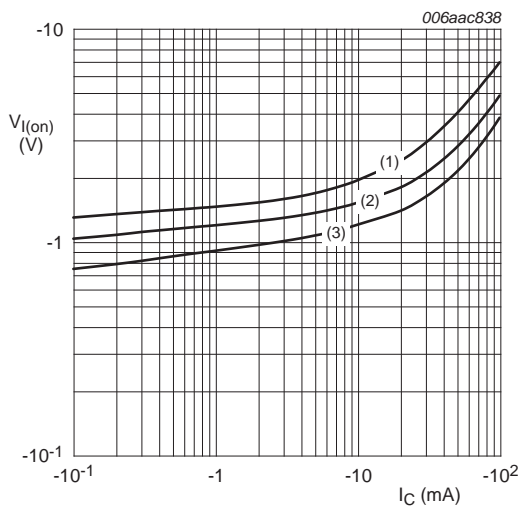

$V_{CE} = -0.3 \text{ V}$   
 (1)  $T_{amb} = -40 \text{ }^\circ\text{C}$   
 (2)  $T_{amb} = 25 \text{ }^\circ\text{C}$   
 (3)  $T_{amb} = 100 \text{ }^\circ\text{C}$

**Fig 8. On-state input voltage as a function of collector current; typical values**

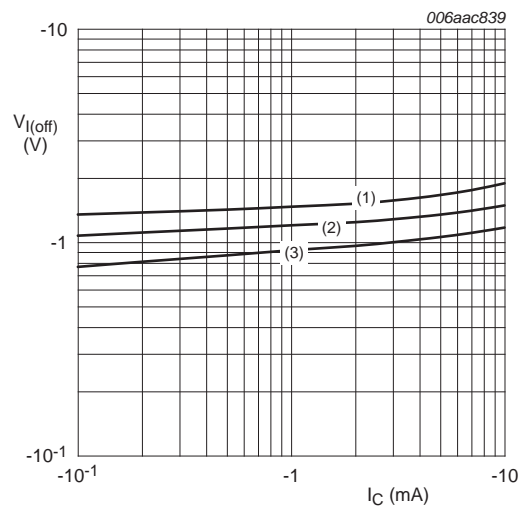

$V_{CE} = -5 \text{ V}$   
 (1)  $T_{amb} = -40 \text{ }^\circ\text{C}$   
 (2)  $T_{amb} = 25 \text{ }^\circ\text{C}$   
 (3)  $T_{amb} = 100 \text{ }^\circ\text{C}$

**Fig 9. Off-state input voltage as a function of collector current; typical values**



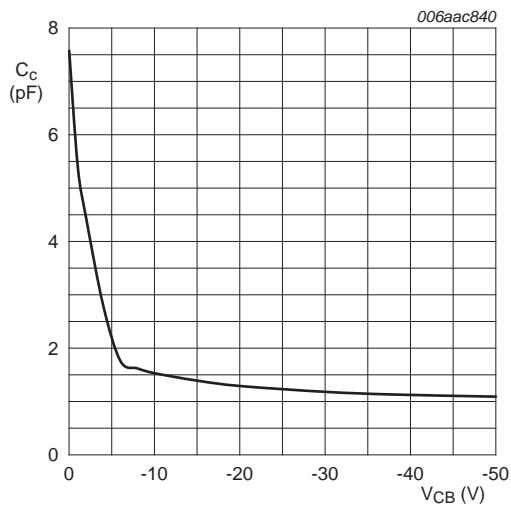

$f = 1 \text{ MHz}$ ;  $T_{\text{amb}} = 25 \text{ }^\circ\text{C}$

**Fig 10.** Collector capacitance as a function of collector-base voltage; typical values

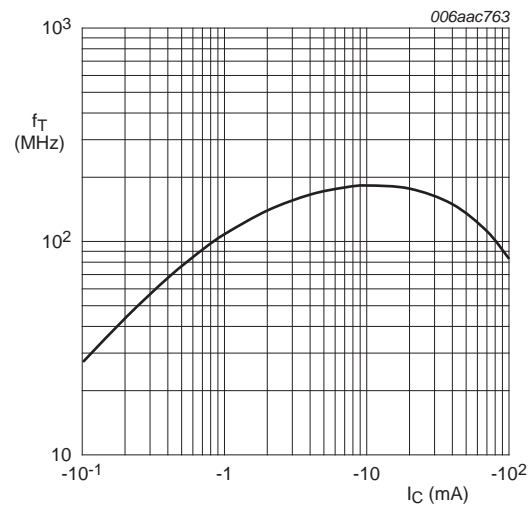

$V_{CE} = -5 \text{ V}$ ;  $T_{\text{amb}} = 25 \text{ }^\circ\text{C}$

**Fig 11.** Transition frequency as a function of collector current; typical values of built-in transistor

## 8. Test information

### 8.1 Quality information

This product has been qualified in accordance with the Automotive Electronics Council (AEC) standard *Q101 - Stress test qualification for discrete semiconductors*, and is suitable for use in automotive applications.

**9. Package outline**

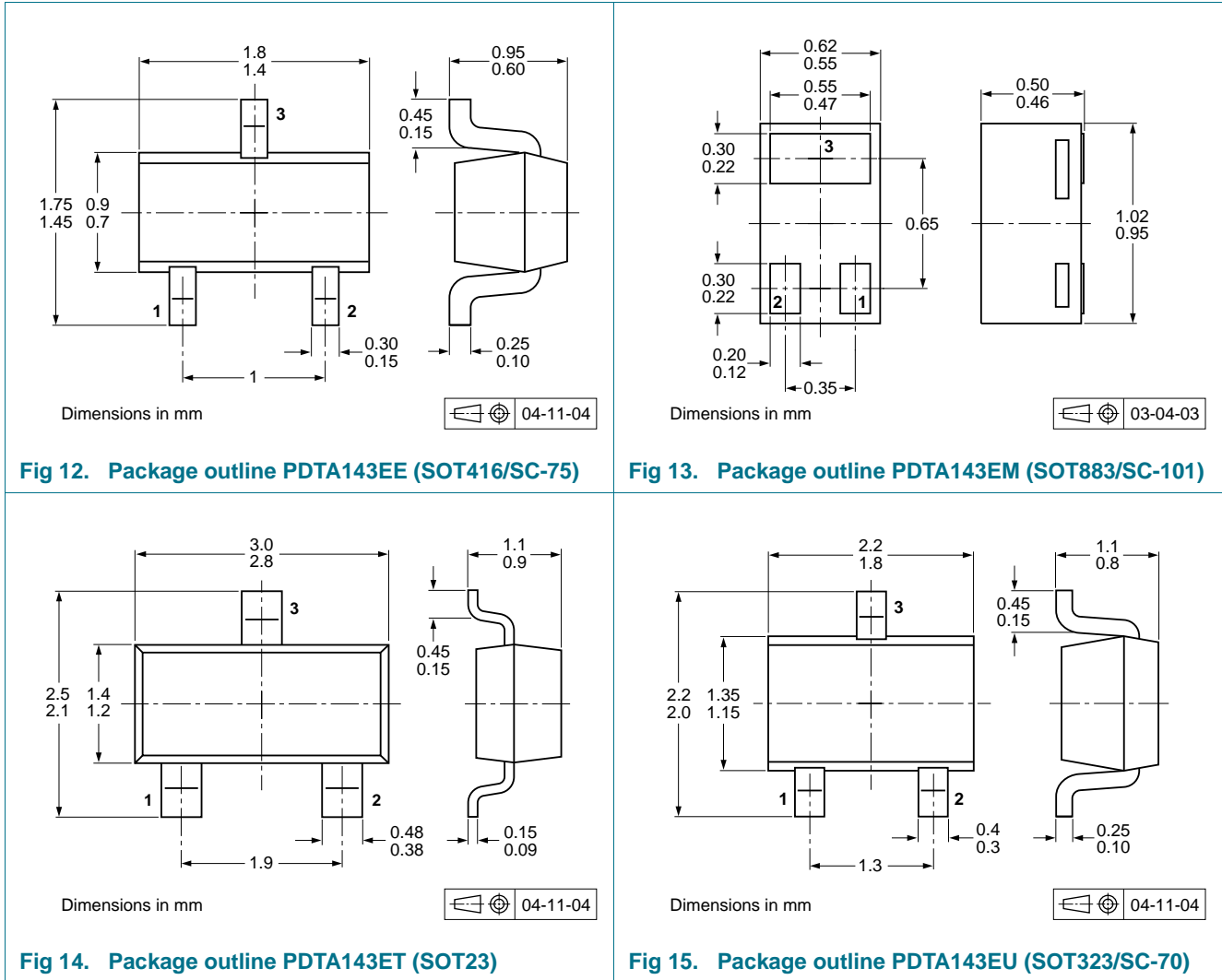

**10. Packing information**

**Table 9. Packing methods**

The indicated -xxx are the last three digits of the 12NC ordering code.<sup>[1]</sup>

Type number	Package	Description	Packing quantity		
			3000	5000	10000
PDTA143EE	SOT416	4 mm pitch, 8 mm tape and reel	-115	-	-135
PDTA143EM	SOT883	2 mm pitch, 8 mm tape and reel	-	-	-315
PDTA143ET	SOT23	4 mm pitch, 8 mm tape and reel	-215	-	-235
PDTA143EU	SOT323	4 mm pitch, 8 mm tape and reel	-115	-	-135

[1] For further information and the availability of packing methods, see [Section 14](#).

**11. Soldering**

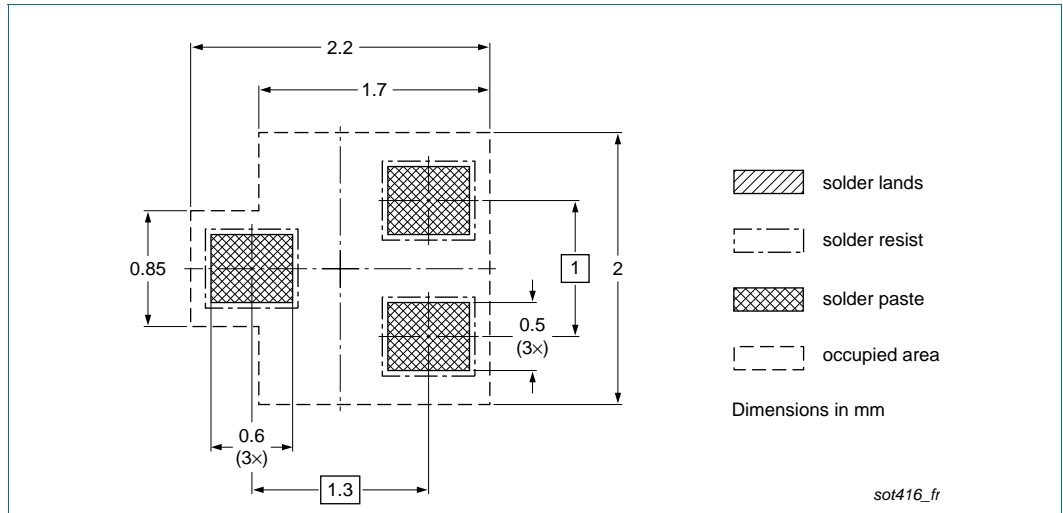

Reflow soldering is the only recommended soldering method.

**Fig 16. Reflow soldering footprint PDTA143EE (SOT416/SC-75)**

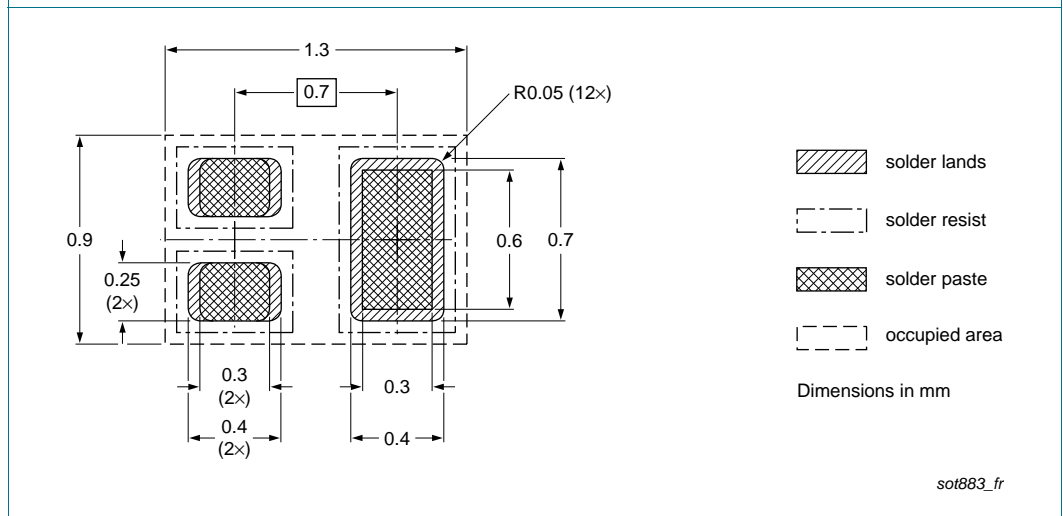

Reflow soldering is the only recommended soldering method.

**Fig 17. Reflow soldering footprint PDTA143EM (SOT883/SC-101)**

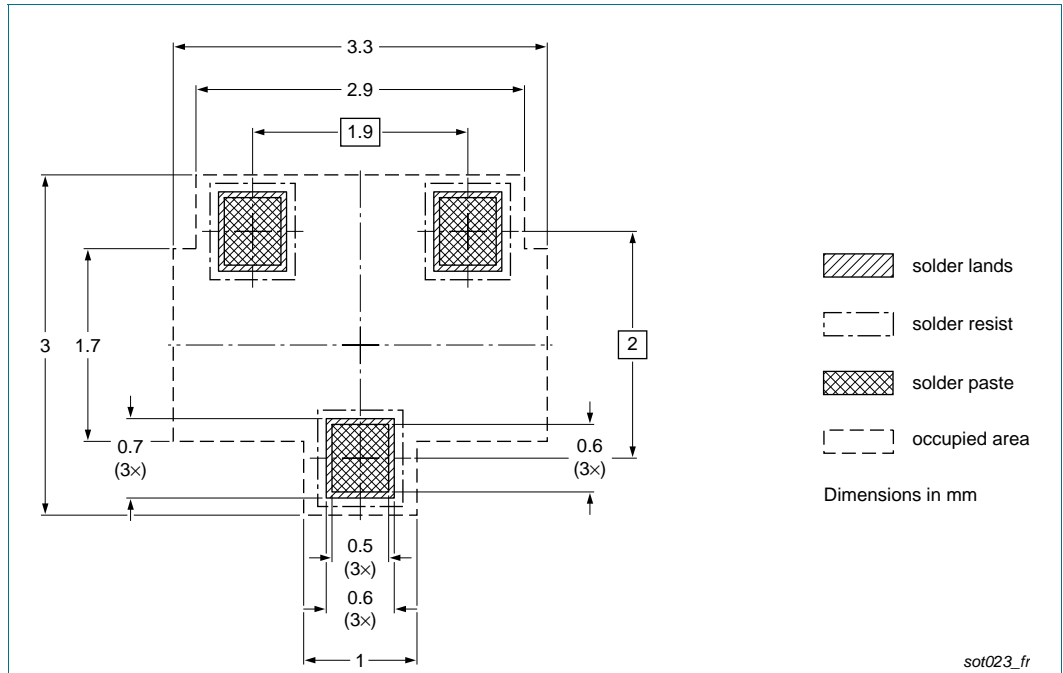

**Fig 18. Reflow soldering footprint PDTA143ET (SOT23)**

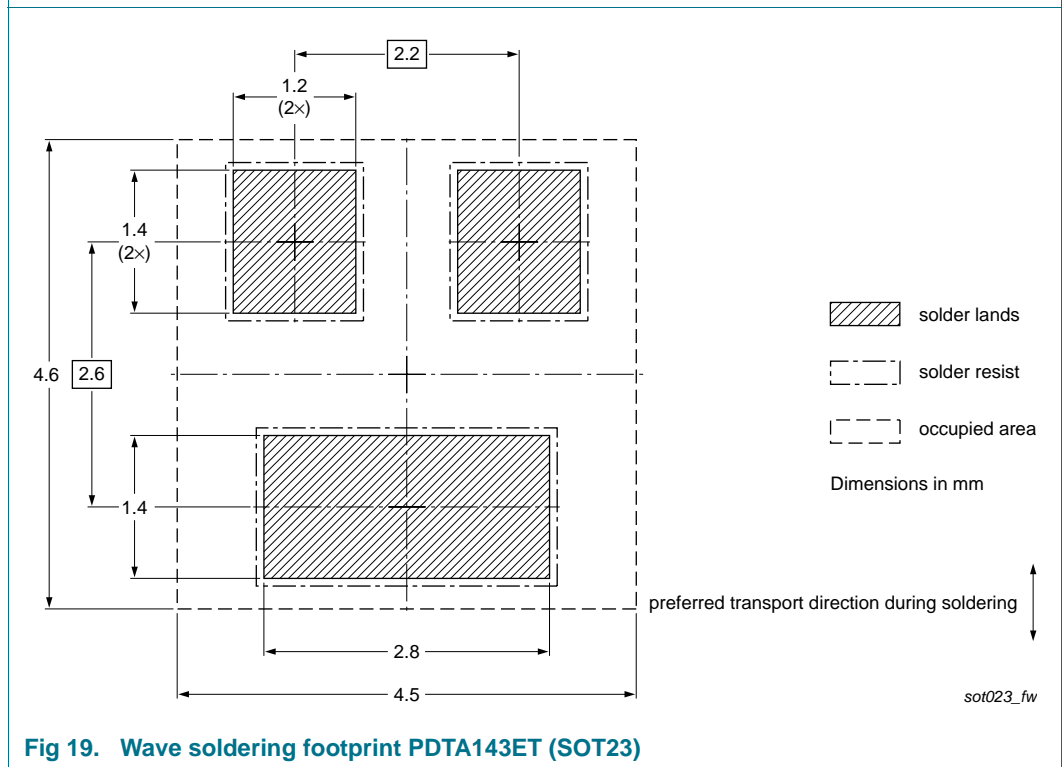

**Fig 19. Wave soldering footprint PDTA143ET (SOT23)**

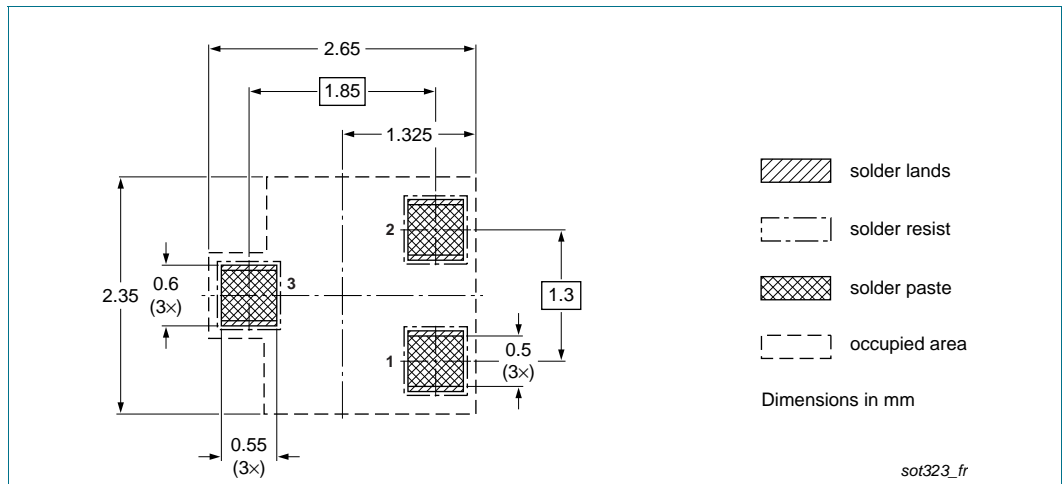

**Fig 20. Reflow soldering footprint PDTA143EU (SOT323/SC-70)**

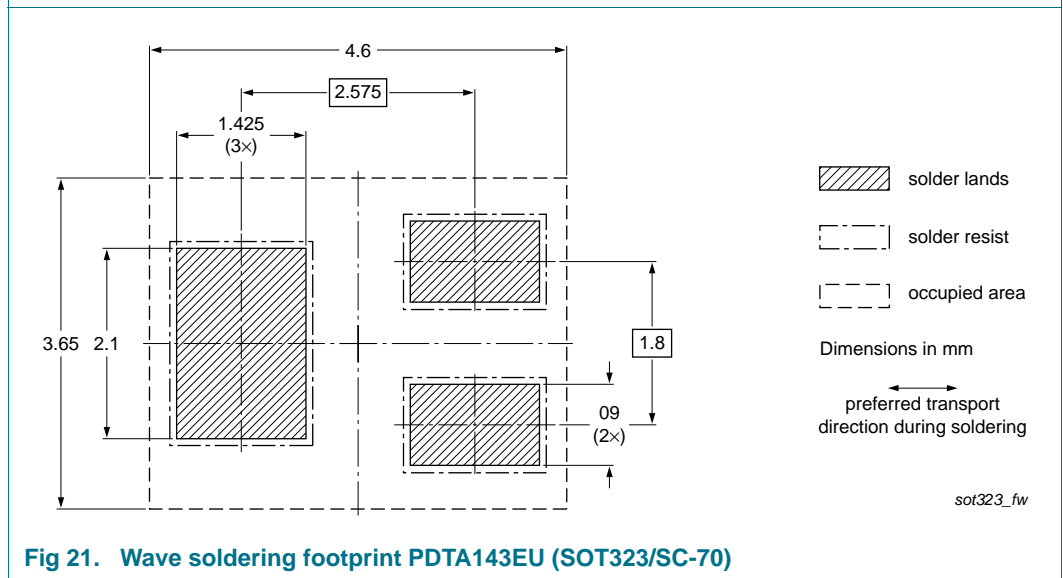

**Fig 21. Wave soldering footprint PDTA143EU (SOT323/SC-70)**

## 12. Revision history

Table 10. Revision history

Document ID	Release date	Data sheet status	Change notice	Supersedes
PDTA143E_SER v.8	20111208	Product data sheet	-	PDTA143E_SERIES v.7
Modifications:	<ul style="list-style-type: none"> <li>• The format of this document has been redesigned to comply with the new identity guidelines of NXP Semiconductors.</li> <li>• Legal texts have been adapted to the new company name where appropriate.</li> <li>• Type numbers PDTA143EEF, PDTA143EK and PDTA143ES removed.</li> <li>• <a href="#">Section 1 "Product profile"</a>: updated</li> <li>• <a href="#">Section 3 "Ordering information"</a>: added</li> <li>• <a href="#">Section 4 "Marking"</a>: updated</li> <li>• <a href="#">Figure 1 to 11</a>: added</li> <li>• <a href="#">Section 6 "Thermal characteristics"</a>: updated</li> <li>• <a href="#">Table 8 "Characteristics"</a>: <math>V_{i(on)}</math> redefined to <math>V_{I(on)}</math> on-state input voltage, <math>V_{i(off)}</math> redefined to <math>V_{I(off)}</math> off-state input voltage, <math>I_{CEO}</math> updated, <math>f_T</math> added</li> <li>• <a href="#">Section 8 "Test information"</a>: added</li> <li>• <a href="#">Section 9 "Package outline"</a>: superseded by minimized package outline drawings</li> <li>• <a href="#">Section 10 "Packing information"</a>: added</li> <li>• <a href="#">Section 11 "Soldering"</a>: added</li> <li>• <a href="#">Section 13 "Legal information"</a>: updated</li> </ul>			
PDTA143E_SERIES v.7	20040804	Product data sheet	-	PDTA143E_SERIES v.6
PDTA143E_SERIES v.6	20030908	Product specification	-	PDTA143E_SERIES v.5
PDTA143E_SERIES v.5	20030411	Product specification	-	-

## 13. Legal information

### 13.1 Data sheet status

Document status <sup>[1][2]</sup>	Product status <sup>[3]</sup>	Definition
Objective [short] data sheet	Development	This document contains data from the objective specification for product development.
Preliminary [short] data sheet	Qualification	This document contains data from the preliminary specification.
Product [short] data sheet	Production	This document contains the product specification.

[1] Please consult the most recently issued document before initiating or completing a design.

[2] The term 'short data sheet' is explained in section "Definitions".

[3] The product status of device(s) described in this document may have changed since this document was published and may differ in case of multiple devices. The latest product status information is available on the Internet at URL <http://www.nexperia.com>.

### 13.2 Definitions

**Draft** — The document is a draft version only. The content is still under internal review and subject to formal approval, which may result in modifications or additions. Nexperia does not give any representations or warranties as to the accuracy or completeness of information included herein and shall have no liability for the consequences of use of such information.

**Short data sheet** — A short data sheet is an extract from a full data sheet with the same product type number(s) and title. A short data sheet is intended for quick reference only and should not be relied upon to contain detailed and full information. For detailed and full information see the relevant full data sheet, which is available on request via the local Nexperia sales office. In case of any inconsistency or conflict with the short data sheet, the full data sheet shall prevail.

**Product specification** — The information and data provided in a Product data sheet shall define the specification of the product as agreed between Nexperia and its customer, unless Nexperia and customer have explicitly agreed otherwise in writing. In no event however, shall an agreement be valid in which the Nexperia product is deemed to offer functions and qualities beyond those described in the Product data sheet.

### 13.3 Disclaimers

**Limited warranty and liability** — Information in this document is believed to be accurate and reliable. However, Nexperia does not give any representations or warranties, expressed or implied, as to the accuracy or completeness of such information and shall have no liability for the consequences of use of such information. Nexperia takes no responsibility for the content in this document if provided by an information source outside of Nexperia.

In no event shall Nexperia be liable for any indirect, incidental, punitive, special or consequential damages (including - without limitation - lost profits, lost savings, business interruption, costs related to the removal or replacement of any products or rework charges) whether or not such damages are based on tort (including negligence), warranty, breach of contract or any other legal theory.

Notwithstanding any damages that customer might incur for any reason whatsoever, Nexperia's aggregate and cumulative liability towards customer for the products described herein shall be limited in accordance with the *Terms and conditions of commercial sale* of Nexperia.

**Right to make changes** — Nexperia reserves the right to make changes to information published in this document, including without limitation specifications and product descriptions, at any time and without notice. This document supersedes and replaces all information supplied prior to the publication hereof.

**Suitability for use** — Nexperia products are not designed, authorized or warranted to be suitable for use in life support, life-critical or safety-critical systems or equipment, nor in applications where failure or malfunction of a Nexperia product can reasonably be expected to result in personal injury, death or severe property or environmental damage. Nexperia and its suppliers accept no liability for inclusion and/or use of Nexperia products in such equipment or applications and therefore such inclusion and/or use is at the customer's own risk.

**Applications** — Applications that are described herein for any of these products are for illustrative purposes only. Nexperia makes no representation or warranty that such applications will be suitable for the specified use without further testing or modification.

Customers are responsible for the design and operation of their applications and products using Nexperia products, and Nexperia accepts no liability for any assistance with applications or customer product design. It is customer's sole responsibility to determine whether the Nexperia product is suitable and fit for the customer's applications and products planned, as well as for the planned application and use of customer's third party customer(s). Customers should provide appropriate design and operating safeguards to minimize the risks associated with their applications and products.

Nexperia does not accept any liability related to any default, damage, costs or problem which is based on any weakness or default in the customer's applications or products, or the application or use by customer's third party customer(s). Customer is responsible for doing all necessary testing for the customer's applications and products using Nexperia products in order to avoid a default of the applications and the products or of the application or use by customer's third party customer(s). Nexperia does not accept any liability in this respect.

**Limiting values** — Stress above one or more limiting values (as defined in the Absolute Maximum Ratings System of IEC 60134) will cause permanent damage to the device. Limiting values are stress ratings only and (proper) operation of the device at these or any other conditions above those given in the Recommended operating conditions section (if present) or the Characteristics sections of this document is not warranted. Constant or repeated exposure to limiting values will permanently and irreversibly affect the quality and reliability of the device.

**Terms and conditions of commercial sale** — Nexperia products are sold subject to the general terms and conditions of commercial sale, as published at <http://www.nexperia.com/profile/terms>, unless otherwise agreed in a valid written individual agreement. In case an individual agreement is concluded only the terms and conditions of the respective agreement shall apply. Nexperia hereby expressly objects to applying the customer's general terms and conditions with regard to the purchase of Nexperia products by customer.

**No offer to sell or license** — Nothing in this document may be interpreted or construed as an offer to sell products that is open for acceptance or the grant, conveyance or implication of any license under any copyrights, patents or other industrial or intellectual property rights.

**Export control** — This document as well as the item(s) described herein may be subject to export control regulations. Export might require a prior authorization from competent authorities.

**Quick reference data** — The Quick reference data is an extract of the product data given in the Limiting values and Characteristics sections of this document, and as such is not complete, exhaustive or legally binding.

## 13.4 Trademarks

Notice: All referenced brands, product names, service names and trademarks are the property of their respective owners.

## 14. Contact information

---

For more information, please visit: <http://www.nexperia.com>

For sales office addresses, please send an email to: [salesaddresses@nexperia.com](mailto:salesaddresses@nexperia.com)



## 15. Contents

<b>1</b>	<b>Product profile</b> . . . . .	<b>1</b>
1.1	General description . . . . .	1
1.2	Features and benefits . . . . .	1
1.3	Applications . . . . .	1
1.4	Quick reference data . . . . .	1
<b>2</b>	<b>Pinning information</b> . . . . .	<b>2</b>
<b>3</b>	<b>Ordering information</b> . . . . .	<b>2</b>
<b>4</b>	<b>Marking</b> . . . . .	<b>2</b>
<b>5</b>	<b>Limiting values</b> . . . . .	<b>3</b>
<b>6</b>	<b>Thermal characteristics</b> . . . . .	<b>4</b>
<b>7</b>	<b>Characteristics</b> . . . . .	<b>7</b>
<b>8</b>	<b>Test information</b> . . . . .	<b>9</b>
8.1	Quality information . . . . .	9
<b>9</b>	<b>Package outline</b> . . . . .	<b>10</b>
<b>10</b>	<b>Packing information</b> . . . . .	<b>10</b>
<b>11</b>	<b>Soldering</b> . . . . .	<b>11</b>
<b>12</b>	<b>Revision history</b> . . . . .	<b>14</b>
<b>13</b>	<b>Legal information</b> . . . . .	<b>15</b>
13.1	Data sheet status . . . . .	15
13.2	Definitions . . . . .	15
13.3	Disclaimers . . . . .	15
13.4	Trademarks . . . . .	16
<b>14</b>	<b>Contact information</b> . . . . .	<b>16</b>
<b>15</b>	<b>Contents</b> . . . . .	<b>17</b>

单击下面可查看定价，库存，交付和生命周期等信息

[>>Nexperia\(安世\)](#)