

# CBTD3384

10-bit level shifting bus switch with 5-bit output enables

Rev. 10 — 12 March 2021

Product data sheet

## 1. General description

The CBTD3384 provides ten bits of high-speed TTL-compatible bus switching. The low ON resistance of the switch allows connections to be made with minimal propagation delay.

The CBTD3384 device is organized as two 5-bit bus switches with two separate output enable ( $1\overline{OE}$ ,  $2\overline{OE}$ ) inputs. When  $n\overline{OE}$  is LOW, the switch is on and port A is connected to the B port. When  $n\overline{OE}$  is HIGH, each switch is disabled.

## 2. Features and benefits

- Designed to be used in 5 V to 3.3 V level shifting applications with internal diode
- 5  $\Omega$  switch connection between two ports
- TTL-compatible control input levels
- Latch-up protection exceeds 100 mA per JESD78
- ESD protection:
  - HBM JESD22-A114E exceeds 2000 V
  - CDM JESD22-C101C exceeds 1000 V
- Specified from -40 °C to +85 °C

## 3. Ordering information

Table 1. Ordering information

| Type number | Package           |         |  |          |
|-------------|-------------------|---------|--|----------|
|             | Temperature range | Name    | Description  | Version  |
| CBTD3384D   | -40 °C to +85 °C  | SO24    | plastic small outline package; 24 leads; body width 7.5 mm             | SOT137-1 |
| CBTD3384PW  | -40 °C to +85 °C  | TSSOP24 | plastic thin shrink small outline package; 24 leads; body width 4.4 mm | SOT355-1 |

### 4. Functional diagram

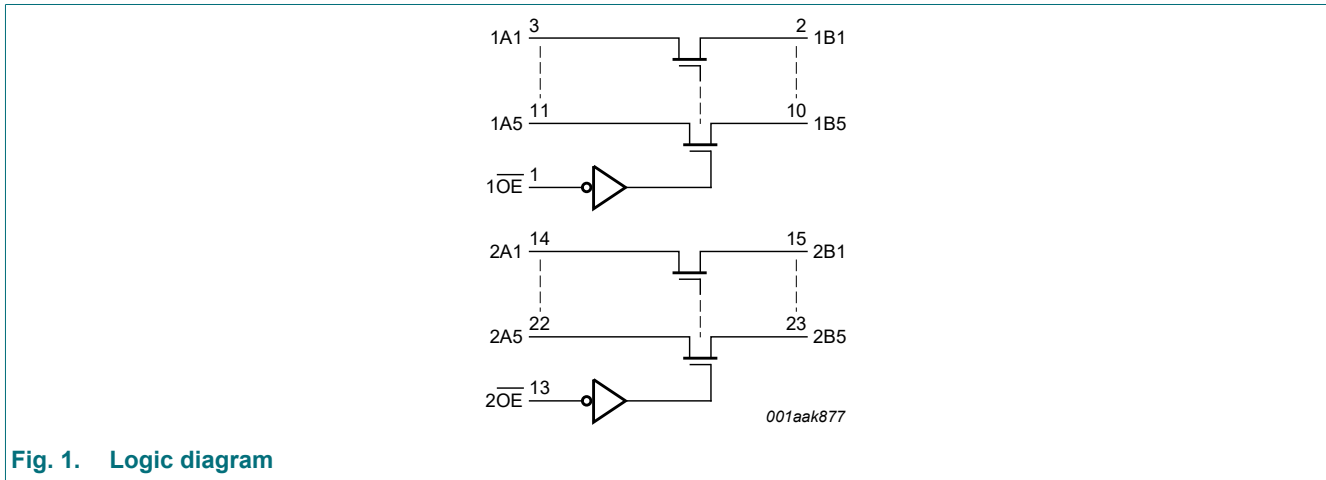

Fig. 1. Logic diagram

### 5. Pinning information

#### 5.1. Pinning

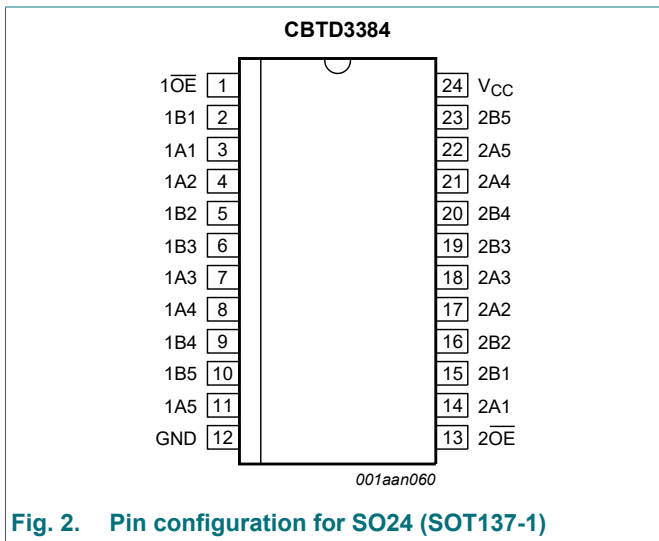

Fig. 2. Pin configuration for SO24 (SOT137-1)

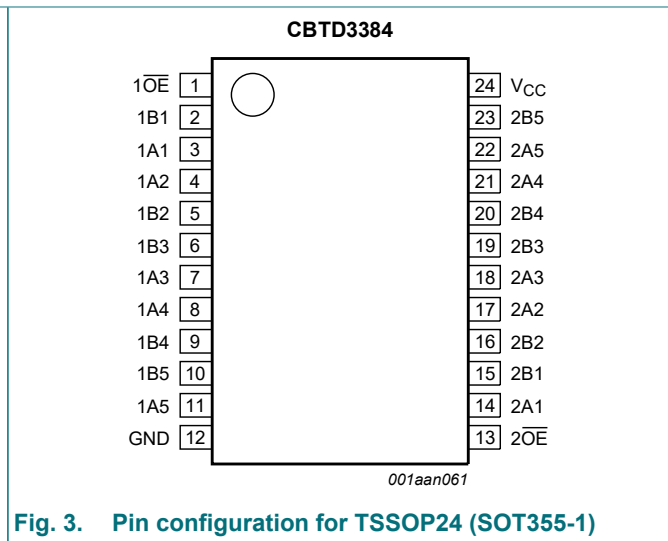

Fig. 3. Pin configuration for TSSOP24 (SOT355-1)

#### 5.2. Pin description

Table 2. Pin description

| Symbol                  | Pin                | Description                      |
|-------------------------|--------------------|----------------------------------|
| 1OE, 2OE                | 1, 13              | output enable input (active LOW) |
| 1A1, 1A2, 1A3, 1A4, 1A5 | 3, 4, 7, 8, 11     | data input/output (A port)       |
| 2A1, 2A2, 2A3, 2A4, 2A5 | 14, 17, 18, 21, 22 | data input/output (A port)       |
| 1B1, 1B2, 1B3, 1B4, 1B5 | 2, 5, 6, 9, 10     | data input/output (B port)       |
| 2B1, 2B2, 2B3, 2B4, 2B5 | 15, 16, 19, 20, 23 | data input/output (B port)       |
| GND                     | 12                 | ground (0 V)                     |
| V <sub>CC</sub>         | 24                 | positive supply voltage          |

## 6. Functional description

**Table 3. Function selection**

*H = HIGH voltage level; L = LOW voltage level; Z = high-impedance OFF-state.*

| Input |     | Input/output |           |
|-------|-----|--------------|-----------|
| 1OE   | 2OE | 1An, 1Bn     | 2An, 2Bn  |
| L     | L   | 1An = 1Bn    | 2An = 2Bn |
| L     | H   | 1An = 1Bn    | Z         |
| H     | L   | Z            | 2An = 2Bn |
| H     | H   | Z            | Z         |

## 7. Limiting values

**Table 4. Limiting values**

*In accordance with the Absolute Maximum Rating System (IEC 60134).*

*T<sub>amb</sub> = -40 °C to +85 °C, unless otherwise specified.*

| Symbol           | Parameter              | Conditions             | Min  | Max  | Unit |
|------------------|------------------------|------------------------|------|------|------|
| V <sub>CC</sub>  | supply voltage         |                        | -0.5 | +7.0 | V    |
| V <sub>I</sub>   | input voltage          | [1]                    | -0.5 | +7.0 | V    |
| I <sub>O</sub>   | output current         | V <sub>O</sub> < 0 V   | -    | ±128 | mA   |
| I <sub>IK</sub>  | input clamping current | V <sub>I/O</sub> = 0 V | -50  | -    | mA   |
| T <sub>stg</sub> | storage temperature    |                        | -65  | +150 | °C   |

[1] The input and output negative-voltage ratings may be exceeded if the input and output clamp-current ratings are observed.

## 8. Recommended operating conditions

**Table 5. Operating conditions**

*All unused control inputs of the device must be held at V<sub>CC</sub> or GND to ensure proper device operation.*

| Symbol           | Parameter                | Conditions            | Min | Typ | Max | Unit |
|------------------|--------------------------|-----------------------|-----|-----|-----|------|
| V <sub>CC</sub>  | supply voltage           |                       | 4.5 | -   | 5.5 | V    |
| V <sub>IH</sub>  | HIGH-level input voltage |                       | 2.0 | -   | -   | V    |
| V <sub>IL</sub>  | LOW-level input voltage  |                       | -   | -   | 0.8 | V    |
| T <sub>amb</sub> | ambient temperature      | operating in free air | -40 | -   | +85 | °C   |

## 9. Static characteristics

**Table 6. Static characteristics**

Voltages are referenced to GND (ground = 0 V).

| Symbol               | Parameter                          | Conditions   | T <sub>amb</sub> = -40 °C to +85 °C |        |      | Unit |
|----------------------|------------------------------------|--|-------------------------------------|--------|------|------|
|                      |                                    |  | Min                                 | Typ[1] | Max  |      |
| V <sub>IK</sub>      | input clamping voltage             | V <sub>CC</sub> = 4.5 V; I <sub>I</sub> = -18 mA   | -                                   | -      | -1.2 | V    |
| I <sub>I</sub>       | input leakage current              | V <sub>CC</sub> = 5.5 V; V <sub>I</sub> = GND or 5.5 V   | -                                   | -      | ±1   | µA   |
| I <sub>CC</sub>      | supply current                     | V <sub>CC</sub> = 5.5 V; I <sub>O</sub> = 0 mA; V <sub>I</sub> = V <sub>CC</sub> or GND                | -                                   | -      | 1.5  | mA   |
| ΔI <sub>CC</sub>     | additional supply current          | per input pin; V <sub>CC</sub> = 5.5 V; one input at 3.4 V, other inputs at V <sub>CC</sub> or GND [2] | -                                   | -      | 2.5  | mA   |
| V <sub>pass</sub>    | pass voltage                       | see Fig. 4 to Fig. 8   | -                                   | -      | -    | V    |
| C <sub>I</sub>       | input capacitance                  | control pins; V <sub>I</sub> = 3 V or 0 V  | -                                   | 3.2    | -    | pF   |
| C <sub>io(off)</sub> | off-state input/output capacitance | port off; V <sub>I</sub> = 3 V or 0 V; n $\overline{OE}$ = V <sub>CC</sub>                             | -                                   | 6.0    | -    | pF   |
| R <sub>ON</sub>      | ON resistance                      | V <sub>CC</sub> = 4.5 V; V <sub>I</sub> = 0 V; I <sub>I</sub> = 64 mA [3]                              | -                                   | 5      | 7    | Ω    |
|                      |                                    | V <sub>CC</sub> = 4.5 V; V <sub>I</sub> = 0 V; I <sub>I</sub> = 30 mA [3]                              | -                                   | 5      | 7    | Ω    |
|                      |                                    | V <sub>CC</sub> = 4.5 V; V <sub>I</sub> = 2.4 V; I <sub>I</sub> = -15 mA [3]                           | -                                   | 17     | 50   | Ω    |

[1] All typical values are at V<sub>CC</sub> = 5 V, T<sub>amb</sub> = 25 °C.

[2] This is the increase in supply current for each input that is at the specified TTL voltage level rather than V<sub>CC</sub> or GND.

[3] Measured by the voltage drop between the nAn and the nBn terminals at the indicated current through the switch. ON resistance is determined by the lowest voltage of the two (nAn or nBn) terminals.

### 9.1. Typical pass voltage graphs

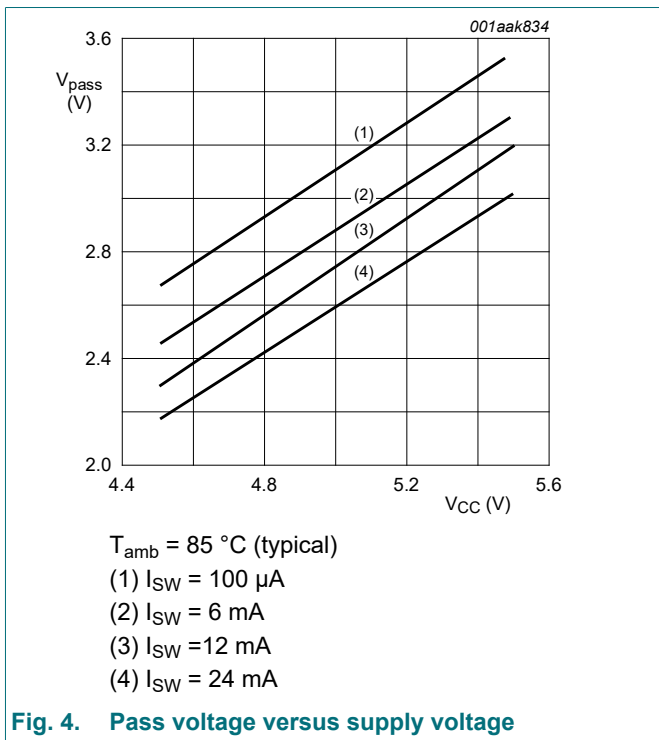

**Fig. 4. Pass voltage versus supply voltage**

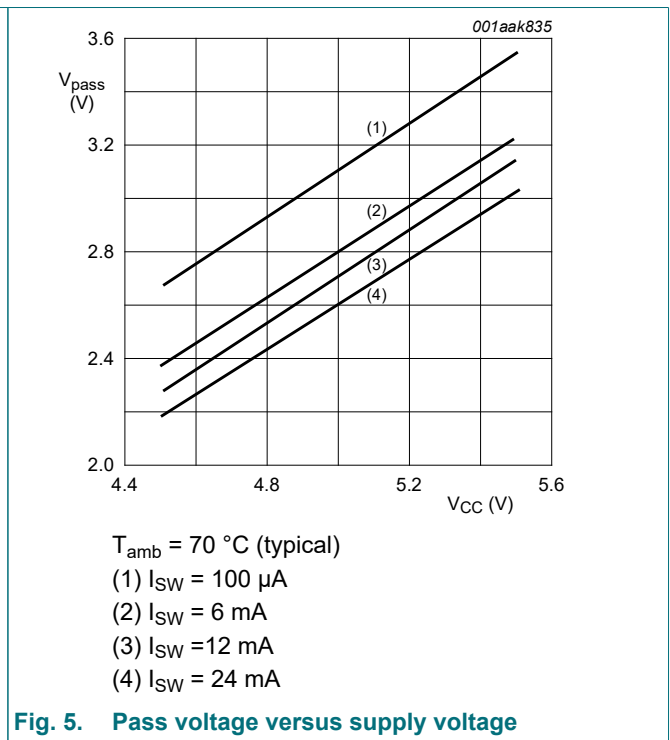

**Fig. 5. Pass voltage versus supply voltage**

10-bit level shifting bus switch with 5-bit output enables

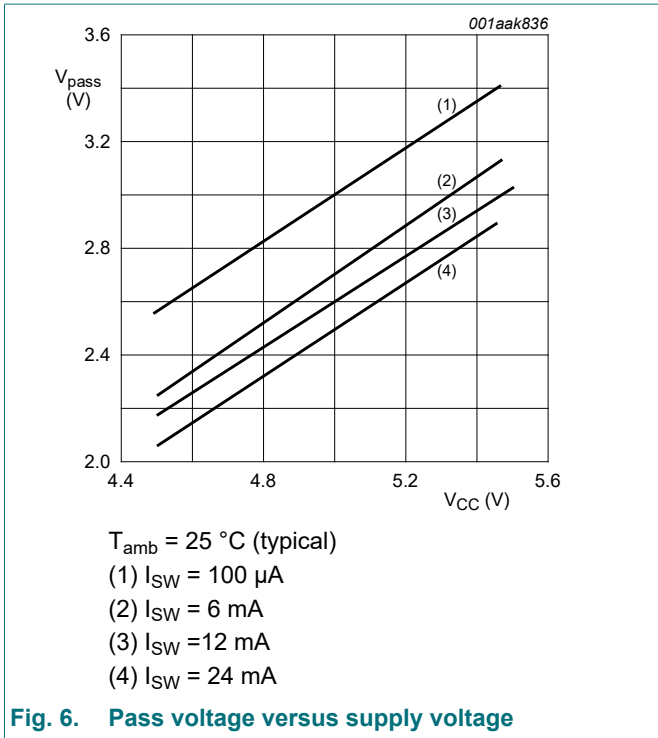

Fig. 6. Pass voltage versus supply voltage

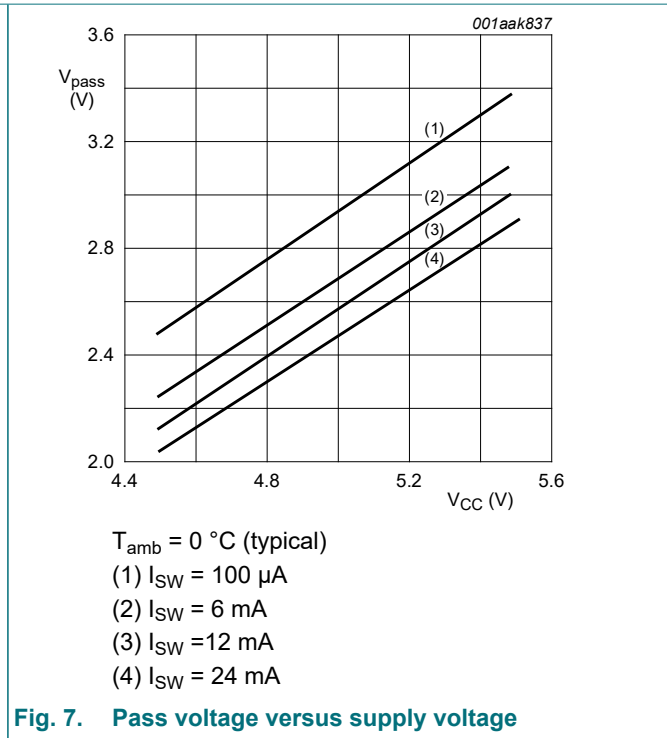

Fig. 7. Pass voltage versus supply voltage

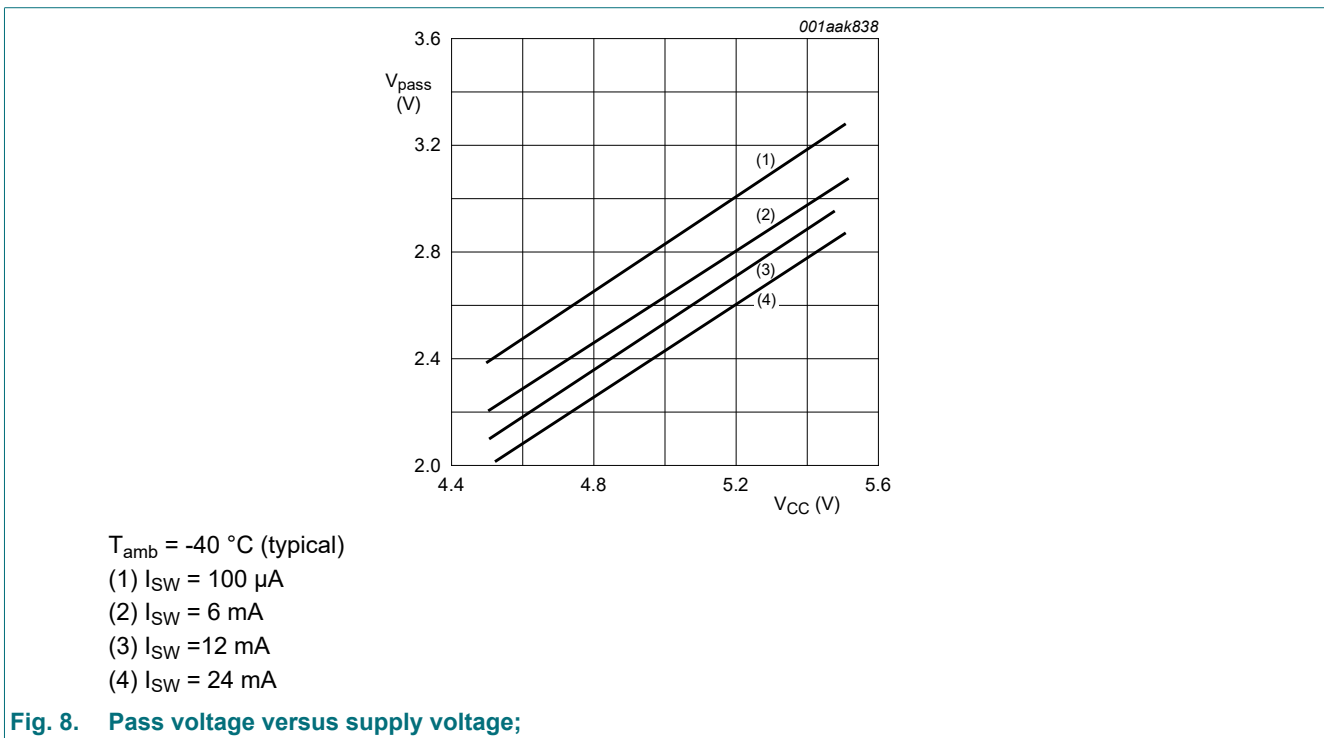

Fig. 8. Pass voltage versus supply voltage;

## 10. Dynamic characteristics

**Table 7. Dynamic characteristics**

Voltages are referenced to GND (ground = 0 V). For test circuit see Fig. 11.

| Symbol           | Parameter         | Conditions                                       | T <sub>amb</sub> = -40 °C to +85 °C |     |      | Unit |
|------------------|-------------------|--|-------------------------------------|-----|------|------|
|                  |                   |  | Min                                 | Typ | Max  |      |
| t <sub>pd</sub>  | propagation delay | nAn, nBn to nBn, nAn; see Fig. 9 [1]<br>[2]      |                                     |     |      |      |
|                  |                   | V <sub>CC</sub> = 5.0 V ± 0.5 V                  | -                                   | -   | 0.25 | ns   |
| t <sub>en</sub>  | enable time       | n $\overline{O}E$ to nAn or nBn; see Fig. 10 [2] |                                     |     |      |      |
|                  |                   | V <sub>CC</sub> = 5.0 V ± 0.5 V                  | 1.2                                 | 4.3 | 7.0  | ns   |
| t <sub>dis</sub> | disable time      | n $\overline{O}E$ to nAn or nBn; see Fig. 10 [2] |                                     |     |      |      |
|                  |                   | V <sub>CC</sub> = 5.0 V ± 0.5 V                  | 1.7                                 | 3.0 | 5.3  | ns   |

- [1] The propagation delay is the calculated RC time constant of the typical ON resistance of the switch and the specified load capacitance, when driven by an ideal voltage source (zero output impedance).
- [2] t<sub>pd</sub> is the same as t<sub>PLH</sub> and t<sub>PHL</sub>.  
t<sub>en</sub> is the same as t<sub>PZL</sub> and t<sub>PZH</sub>.  
t<sub>dis</sub> is the same as t<sub>PLZ</sub> and t<sub>PHZ</sub>.

### 10.1. Waveforms and test circuit

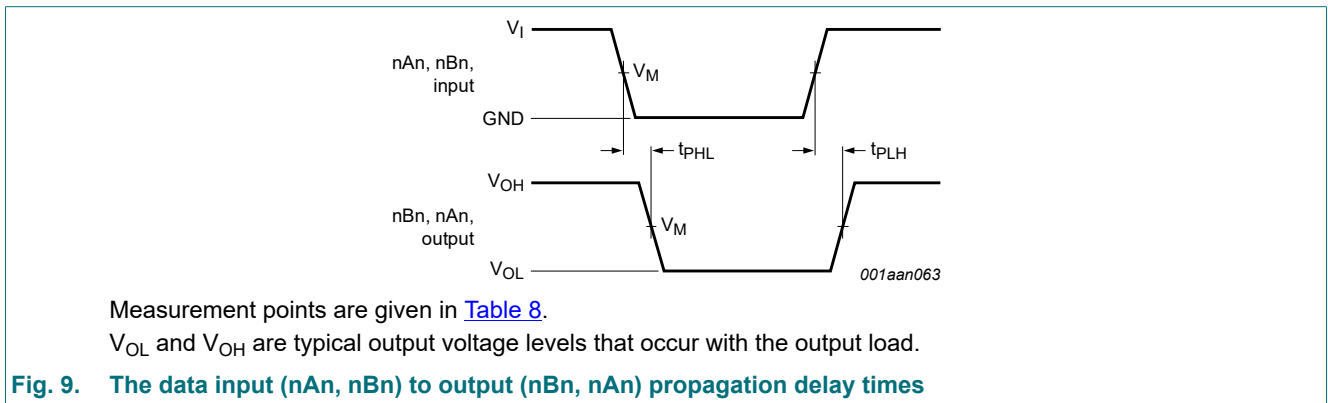

10-bit level shifting bus switch with 5-bit output enables

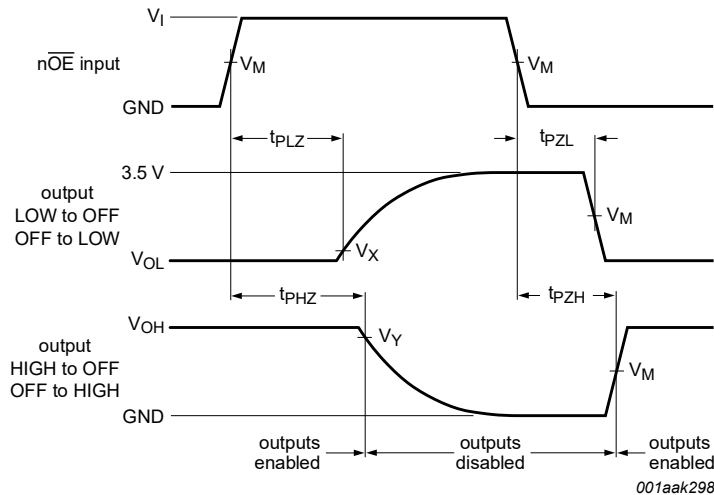

Measurement points are given in [Table 8](#).

$V_{OL}$  and  $V_{OH}$  are typical output voltage levels that occur with the output load.

**Fig. 10. Enable and disable times**

**Table 8. Measurement points**

| Supply voltage                           | Input        |       | Output |                         |                         |
|--|--------------|-------|--------|-------------------------|-------------------------|
| $V_{CC}$                                 | $V_I$        | $V_M$ | $V_M$  | $V_X$                   | $V_Y$                   |
| $V_{CC} = 5.0\text{ V} \pm 0.5\text{ V}$ | GND to 3.0 V | 1.5 V | 1.5 V  | $V_{OL} + 0.3\text{ V}$ | $V_{OH} - 0.3\text{ V}$ |

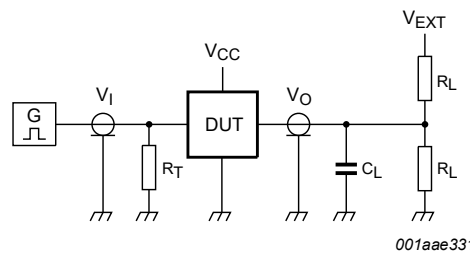
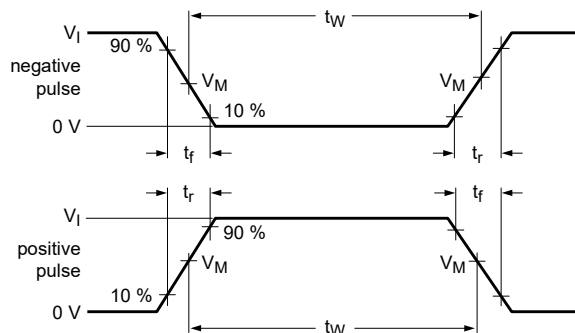

Test data is given in [Table 9](#).

All input pulses are supplied by generators having the following characteristics:  $PRR \leq 10\text{ MHz}$ ;  $Z_o = 50\ \Omega$ .

The outputs are measured one at a time with one transition per measurement.

Definitions for test circuit:

$R_L$  = Load resistance.

$C_L$  = Load capacitance including jig and probe capacitance.

$R_T$  = Termination resistance should be equal to output impedance  $Z_o$  of the pulse generator.

$V_{EXT}$  = External voltage for measuring switching times.

**Fig. 11. Test circuit for measuring switching times**

## 10-bit level shifting bus switch with 5-bit output enables

Table 9. Test data

| Supply voltage                  | Input          |                                 | Load           |                | V <sub>EXT</sub>                    |                                     |                                     |
|---------------------------------|----------------|---------------------------------|----------------|----------------|-------------------------------------|-------------------------------------|-------------------------------------|
|                                 | V <sub>I</sub> | t <sub>r</sub> , t <sub>f</sub> | C <sub>L</sub> | R <sub>L</sub> | t <sub>PLH</sub> , t <sub>PHL</sub> | t <sub>PLZ</sub> , t <sub>PZL</sub> | t <sub>PHZ</sub> , t <sub>PZH</sub> |
| V <sub>CC</sub> = 5.0 V ± 0.5 V | GND to 3.0 V   | ≤ 2.5 ns                        | 50 pF          | 500 Ω          | open                                | 7.0 V                               | open                                |



### 11. Package outline

SO24: plastic small outline package; 24 leads; body width 7.5 mm

SOT137-1

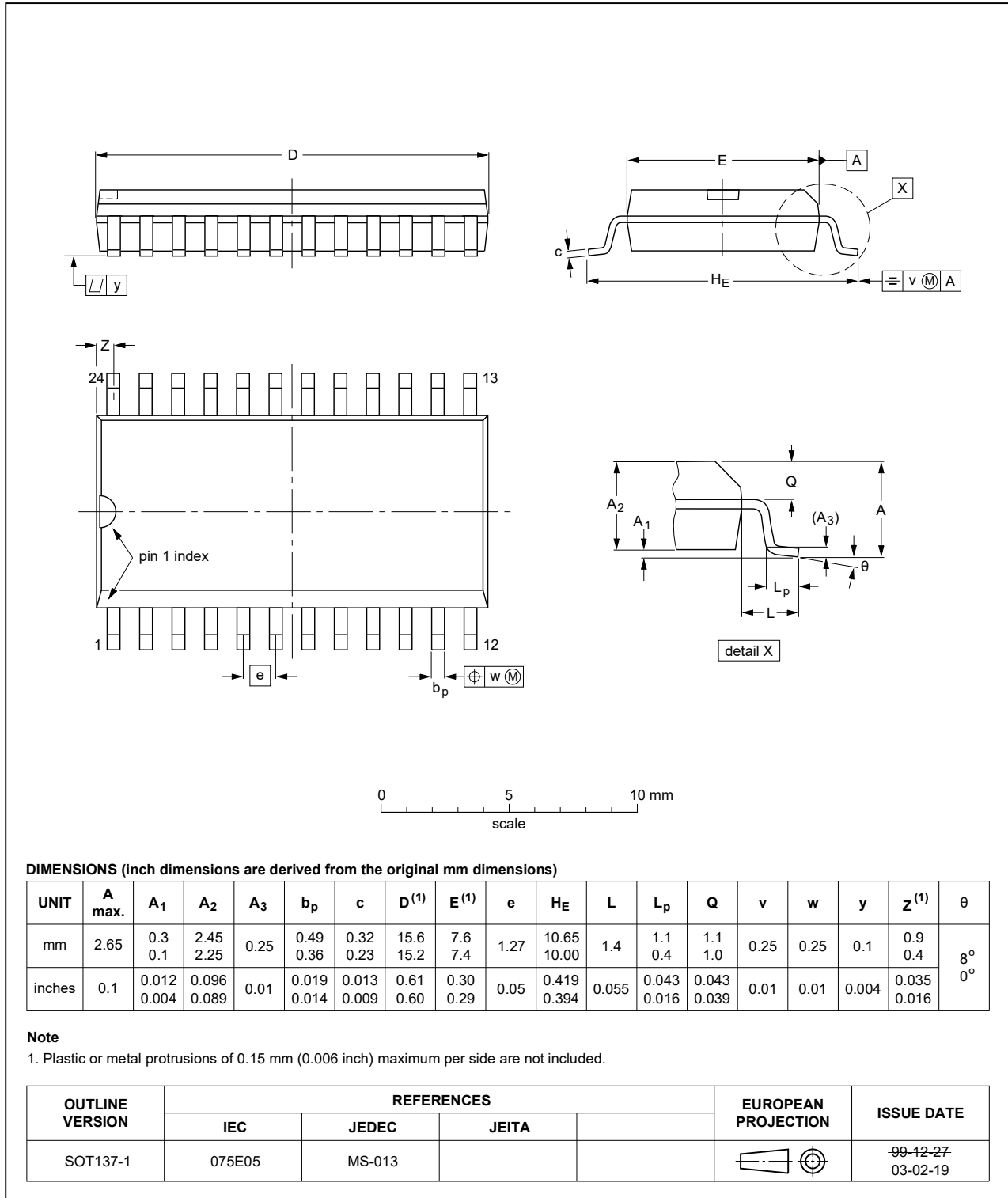

Fig. 12. Package outline SOT137-1 (SO24)

TSSOP24: plastic thin shrink small outline package; 24 leads; body width 4.4 mm

SOT355-1

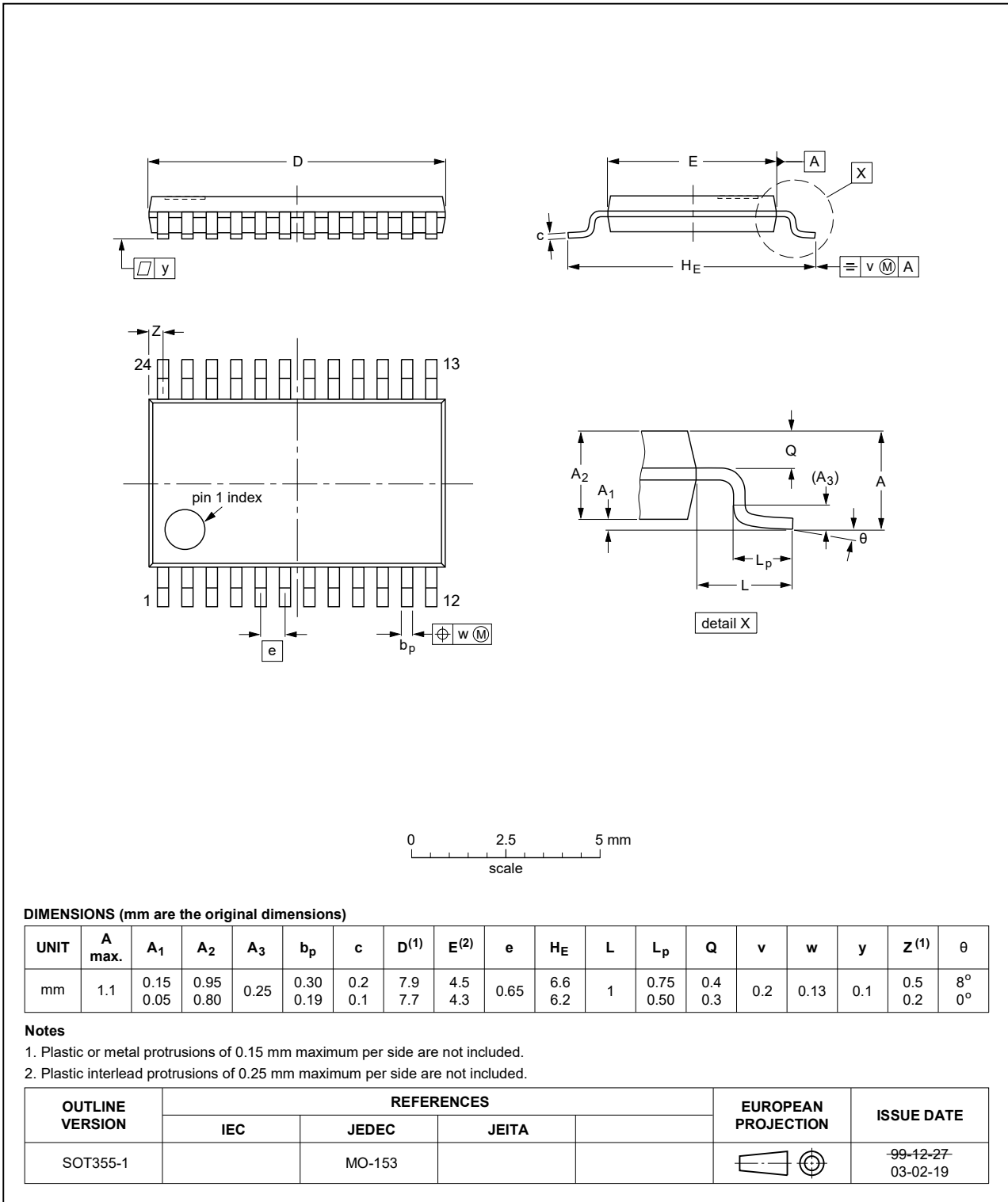

Fig. 13. Package outline SOT355-1 (TSSOP24)

## 12. Abbreviations

Table 10. Abbreviations

| Acronym | Description                 |
|---------|-----------------------------|
| CDM     | Charged Device Model        |
| ESD     | ElectroStatic Discharge     |
| HBM     | Human Body Model            |
| PRR     | Pulse Rate Repetition       |
| TTL     | Transistor-Transistor Logic |

## 13. Revision history

Table 11. Revision history

| Document ID    | Release date  | Data sheet status     | Change notice | Supersedes   |
|----------------|---|-----------------------|---------------|--------------|
| CBTD3384 v.10  | 20210312  | Product data sheet    | -             | CBTD3384 v.9 |
| Modifications: | <ul style="list-style-type: none"> <li>Type number CBTD3384DB (SOT340-1 / SSOP24) removed.</li> </ul>   |                       |               |              |
| CBTD3384 v.9   | 20190306  | Product data sheet    | -             | CBT3384 v.8  |
| Modifications: | <ul style="list-style-type: none"> <li>The format of this data sheet has been redesigned to comply with the identity guidelines of Nexperia.</li> <li>Legal texts have been adapted to the new company name where appropriate.</li> <li>Type number CBTD3384DK (SOT556-1) removed.</li> </ul> |                       |               |              |
| CBTD3384 v.8   | 20121212  | Product data sheet    | -             | CBT3384 v.7  |
| Modifications: | <ul style="list-style-type: none"> <li><a href="#">Table 1</a>: changed +125 °C into +85 °C (errata).</li> </ul>  |                       |               |              |
| CBTD3384 v.7   | 20121119  | Product data sheet    | -             | CBT3384 v.6  |
| Modifications: | <ul style="list-style-type: none"> <li><a href="#">Table 1</a>: changed +85 °C into +125 °C (errata).</li> </ul>  |                       |               |              |
| CBTD3384 v.6   | 20111121  | Product data sheet    | -             | CBTD3384 v.5 |
| Modifications: | <ul style="list-style-type: none"> <li>Legal pages updated.</li> </ul>  |                       |               |              |
| CBTD3384 v.5   | 20101119  | Product data sheet    | -             | CBTD3384 v.4 |
| CBTD3384 v.4   | 20011220  | Product specification |               | CBTD3384 v.3 |
| CBTD3384 v.3   | 20000830  | Product specification | -             | CBTD3384 v.2 |
| CBTD3384 v.2   | 20000830  | Product specification | -             | -            |

## 14. Legal information

### Data sheet status

| Document status [1][2]         | Product status [3] | Definition  |
|--------------------------------|--------------------|---|
| Objective [short] data sheet   | Development        | This document contains data from the objective specification for product development. |
| Preliminary [short] data sheet | Qualification      | This document contains data from the preliminary specification.                       |
| Product [short] data sheet     | Production         | This document contains the product specification.                                     |

- [1] Please consult the most recently issued document before initiating or completing a design.
- [2] The term 'short data sheet' is explained in section "Definitions".
- [3] The product status of device(s) described in this document may have changed since this document was published and may differ in case of multiple devices. The latest product status information is available on the internet at <https://www.nexperia.com>.

### Definitions

**Draft** — The document is a draft version only. The content is still under internal review and subject to formal approval, which may result in modifications or additions. Nexperia does not give any representations or warranties as to the accuracy or completeness of information included herein and shall have no liability for the consequences of use of such information.

**Short data sheet** — A short data sheet is an extract from a full data sheet with the same product type number(s) and title. A short data sheet is intended for quick reference only and should not be relied upon to contain detailed and full information. For detailed and full information see the relevant full data sheet, which is available on request via the local Nexperia sales office. In case of any inconsistency or conflict with the short data sheet, the full data sheet shall prevail.

**Product specification** — The information and data provided in a Product data sheet shall define the specification of the product as agreed between Nexperia and its customer, unless Nexperia and customer have explicitly agreed otherwise in writing. In no event however, shall an agreement be valid in which the Nexperia product is deemed to offer functions and qualities beyond those described in the Product data sheet.

### Disclaimers

**Limited warranty and liability** — Information in this document is believed to be accurate and reliable. However, Nexperia does not give any representations or warranties, expressed or implied, as to the accuracy or completeness of such information and shall have no liability for the consequences of use of such information. Nexperia takes no responsibility for the content in this document if provided by an information source outside of Nexperia.

In no event shall Nexperia be liable for any indirect, incidental, punitive, special or consequential damages (including - without limitation - lost profits, lost savings, business interruption, costs related to the removal or replacement of any products or rework charges) whether or not such damages are based on tort (including negligence), warranty, breach of contract or any other legal theory.

Notwithstanding any damages that customer might incur for any reason whatsoever, Nexperia's aggregate and cumulative liability towards customer for the products described herein shall be limited in accordance with the Terms and conditions of commercial sale of Nexperia.

**Right to make changes** — Nexperia reserves the right to make changes to information published in this document, including without limitation specifications and product descriptions, at any time and without notice. This document supersedes and replaces all information supplied prior to the publication hereof.

**Suitability for use** — Nexperia products are not designed, authorized or warranted to be suitable for use in life support, life-critical or safety-critical systems or equipment, nor in applications where failure or malfunction of an Nexperia product can reasonably be expected to result in personal

injury, death or severe property or environmental damage. Nexperia and its suppliers accept no liability for inclusion and/or use of Nexperia products in such equipment or applications and therefore such inclusion and/or use is at the customer's own risk.

**Quick reference data** — The Quick reference data is an extract of the product data given in the Limiting values and Characteristics sections of this document, and as such is not complete, exhaustive or legally binding.

**Applications** — Applications that are described herein for any of these products are for illustrative purposes only. Nexperia makes no representation or warranty that such applications will be suitable for the specified use without further testing or modification.

Customers are responsible for the design and operation of their applications and products using Nexperia products, and Nexperia accepts no liability for any assistance with applications or customer product design. It is customer's sole responsibility to determine whether the Nexperia product is suitable and fit for the customer's applications and products planned, as well as for the planned application and use of customer's third party customer(s). Customers should provide appropriate design and operating safeguards to minimize the risks associated with their applications and products.

Nexperia does not accept any liability related to any default, damage, costs or problem which is based on any weakness or default in the customer's applications or products, or the application or use by customer's third party customer(s). Customer is responsible for doing all necessary testing for the customer's applications and products using Nexperia products in order to avoid a default of the applications and the products or of the application or use by customer's third party customer(s). Nexperia does not accept any liability in this respect.

**Limiting values** — Stress above one or more limiting values (as defined in the Absolute Maximum Ratings System of IEC 60134) will cause permanent damage to the device. Limiting values are stress ratings only and (proper) operation of the device at these or any other conditions above those given in the Recommended operating conditions section (if present) or the Characteristics sections of this document is not warranted. Constant or repeated exposure to limiting values will permanently and irreversibly affect the quality and reliability of the device.

**Terms and conditions of commercial sale** — Nexperia products are sold subject to the general terms and conditions of commercial sale, as published at <http://www.nexperia.com/profile/terms>, unless otherwise agreed in a valid written individual agreement. In case an individual agreement is concluded only the terms and conditions of the respective agreement shall apply. Nexperia hereby expressly objects to applying the customer's general terms and conditions with regard to the purchase of Nexperia products by customer.

**No offer to sell or license** — Nothing in this document may be interpreted or construed as an offer to sell products that is open for acceptance or the grant, conveyance or implication of any license under any copyrights, patents or other industrial or intellectual property rights.

**Export control** — This document as well as the item(s) described herein may be subject to export control regulations. Export might require a prior authorization from competent authorities.

**Non-automotive qualified products** — Unless this data sheet expressly states that this specific Nexperia product is automotive qualified, the product is not suitable for automotive use. It is neither qualified nor tested in accordance with automotive testing or application requirements. Nexperia accepts no liability for inclusion and/or use of non-automotive qualified products in automotive equipment or applications.

In the event that customer uses the product for design-in and use in automotive applications to automotive specifications and standards, customer (a) shall use the product without Nexperia's warranty of the product for such automotive applications, use and specifications, and (b) whenever customer uses the product for automotive applications beyond Nexperia's specifications such use shall be solely at customer's own risk, and (c) customer fully indemnifies Nexperia for any liability, damages or failed product claims resulting from customer design and use of the product for automotive applications beyond Nexperia's standard warranty and Nexperia's product specifications.

**Translations** — A non-English (translated) version of a document is for reference only. The English version shall prevail in case of any discrepancy between the translated and English versions.

### Trademarks

Notice: All referenced brands, product names, service names and trademarks are the property of their respective owners.

## Contents

|  |           |
|--|-----------|
| <b>1. General description</b> .....              | <b>1</b>  |
| <b>2. Features and benefits</b> .....            | <b>1</b>  |
| <b>3. Ordering information</b> .....             | <b>1</b>  |
| <b>4. Functional diagram</b> .....               | <b>2</b>  |
| <b>5. Pinning information</b> .....              | <b>2</b>  |
| 5.1. Pinning.....                                | 2         |
| 5.2. Pin description.....                        | 2         |
| <b>6. Functional description</b> .....           | <b>3</b>  |
| <b>7. Limiting values</b> .....                  | <b>3</b>  |
| <b>8. Recommended operating conditions</b> ..... | <b>3</b>  |
| <b>9. Static characteristics</b> .....           | <b>4</b>  |
| 9.1. Typical pass voltage graphs.....            | 4         |
| <b>10. Dynamic characteristics</b> .....         | <b>6</b>  |
| 10.1. Waveforms and test circuit.....            | 6         |
| <b>11. Package outline</b> .....                 | <b>9</b>  |
| <b>12. Abbreviations</b> .....                   | <b>11</b> |
| <b>13. Revision history</b> .....                | <b>11</b> |
| <b>14. Legal information</b> .....               | <b>12</b> |

© Nexperia B.V. 2021. All rights reserved

For more information, please visit: <http://www.nexperia.com>

For sales office addresses, please send an email to: [salesaddresses@nexperia.com](mailto:salesaddresses@nexperia.com)

Date of release: 12 March 2021

单击下面可查看定价，库存，交付和生命周期等信息

[>>Nexperia\(安世\)](#)