

HEF4046B

Phase-locked loop

Rev. 6 — 24 March 2016

Product data sheet

1. General description

The HEF4046B is a phase-locked loop circuit that consists of a linear Voltage Controlled Oscillator (VCO) and two different phase comparators with a common signal input amplifier and a common comparator input. A 7 V regulator (Zener) diode is provided for supply voltage regulation if necessary. For a functional description see [Section 6](#).

It operates over a recommended V_{DD} power supply range of 3 V to 15 V referenced to V_{SS} (usually ground). Unused inputs must be connected to V_{DD} , V_{SS} , or another input.

2. Features and benefits

- Fully static operation
- 5 V, 10 V, and 15 V parametric ratings
- Standardized symmetrical output characteristics
- Specified from $-40\text{ }^{\circ}\text{C}$ to $+85\text{ }^{\circ}\text{C}$
- Complies with JEDEC standard JESD 13-B

3. Ordering information

Table 1. Ordering information

All types operate from $-40\text{ }^{\circ}\text{C}$ to $+85\text{ }^{\circ}\text{C}$.

Type number	Package		
	Name	Description	Version
HEF4046BT	SO16	plastic small outline package; 16 leads; body width 3.9 mm	SOT109-1

nexperia

4. Functional diagram

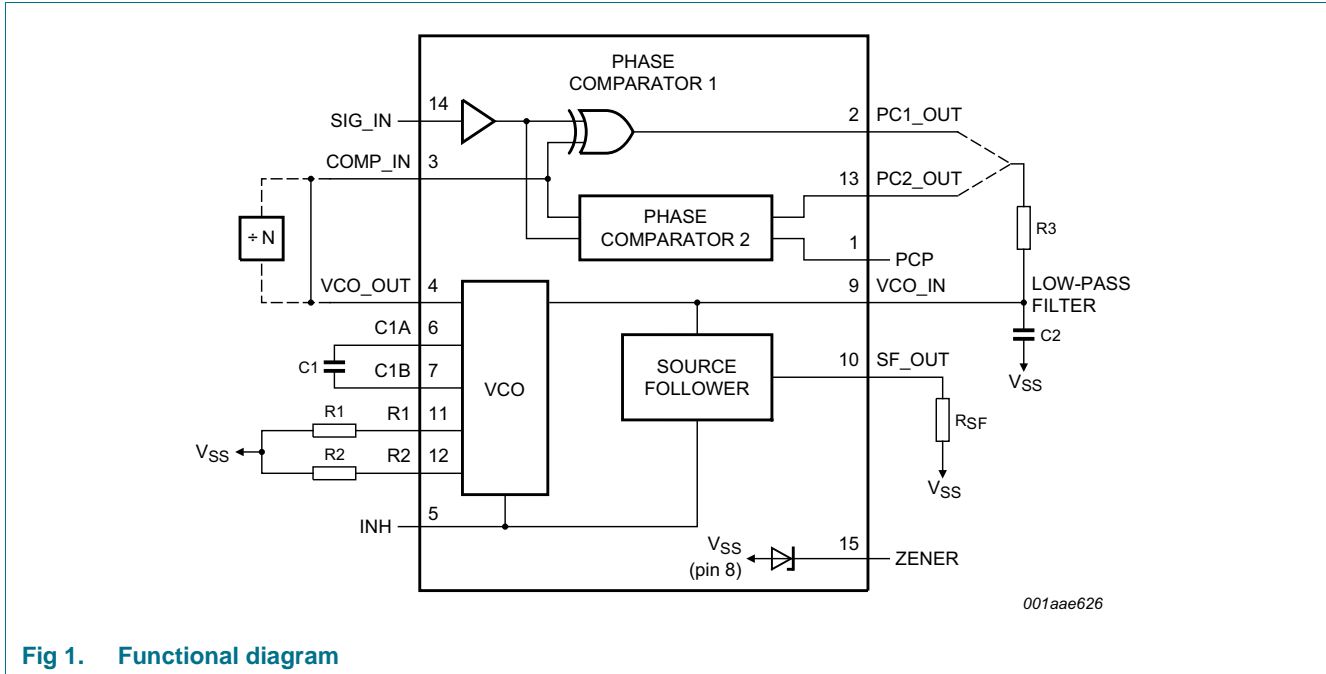

Fig 1. Functional diagram

5. Pinning information

5.1 Pinning

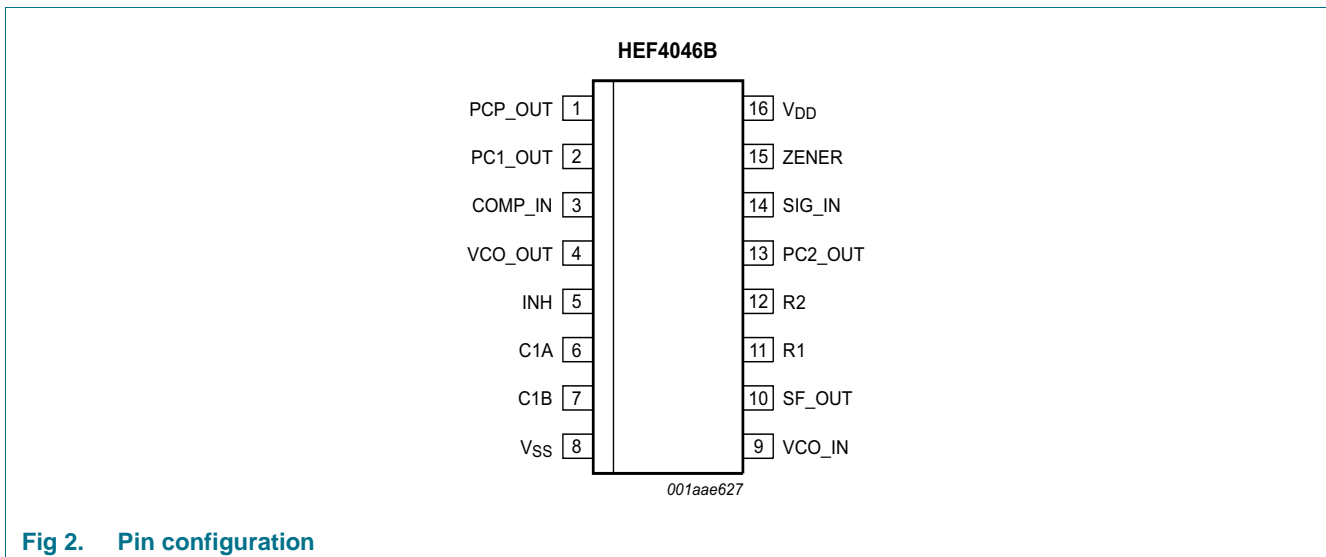

Fig 2. Pin configuration

5.2 Pin description

Table 2. Pin description

Symbol	Pin	Description
PCP_OUT	1	phase comparator pulse output
PC1_OUT	2	phase comparator 1 output
COMP_IN	3	comparator input
VCO_OUT	4	VCO output
INH	5	inhibit input
C1A	6	capacitor C1 connection A
C1B	7	capacitor C1 connection B
V _{SS}	8	ground supply voltage
VCO_IN	9	VCO input
SF_OUT	10	source-follower output
R1	11	resistor R1 connection
R2	12	resistor R2 connection
PC2_OUT	13	phase comparator 2 output
SIG_IN	14	signal input
ZENER	15	Zener diode input for regulated supply
V _{DD}	16	supply voltage

6. Functional description

6.1 VCO control

The VCO requires an external capacitor (C1) and resistor (R1) with an optional resistor (R2). Resistor R1 and capacitor C1 determine the frequency range of the VCO, while resistor R2 enables the VCO to have a frequency off-set if required. The high input impedance of the VCO simplifies the design of low-pass filters; it permits the designer a wide choice of resistor/capacitor ranges. In order not to load the low-pass filter, a source-follower output of the VCO input voltage is provided at SF_OUT (pin 10). If this is used, a load resistor (R_L) should be connected from SF_OUT to V_{SS}; if unused, SF_OUT should be left open. The VCO output (pin 4) can either be connected directly to the comparator input COMP_IN (pin 3) or via a frequency divider. A LOW-level at the inhibit input INH_IN (pin 5) enables the VCO and the source follower, while a HIGH-level turns both off to minimize standby power consumption.

6.2 Phase comparators

The phase-comparator signal input SIG_IN (pin 14) can be direct-coupled, provided the signal swing is between the standard HE4000B family input logic levels. The signal must be capacitively coupled to the self-biasing amplifier at the signal input with smaller swings. Phase comparator 1 is an EXCLUSIVE-OR network. The signal and comparator input frequencies must have a 50 % duty factor to obtain the maximum lock range. The average output voltage of the phase comparator is equal to $0.5V_{DD}$ when there is no signal or noise at the signal input. The average voltage to the VCO input VCO_IN is supplied by the low-pass filter connected to the output of phase comparator 1. This also causes the VCO to oscillate at the center frequency (f_0). The frequency capture range ($2f_c$) is defined as

the frequency range of input signals on which the PLL will lock if it was initially out of lock. The frequency lock range ($2f_L$) is defined as the frequency range of input signals on which the loop will stay locked if it was initially in lock. The capture range is smaller or equal to the lock range.

With phase comparator 1, the range of frequencies over which the PLL can acquire lock (capture range) depends on the low-pass filter characteristics and this range can be made as large as the lock range. Phase comparator 1 enables the PLL system to remain in lock in spite of high amounts of noise in the input signal. A typical behavior of this type of phase comparator is that it may lock onto input frequencies that are close to harmonics of the VCO center frequency. Another typical behavior is that the phase angle between the signal and comparator input varies between 0° and 180° , and is 90° at the center frequency. [Figure 3](#) shows the typical phase-to-output response characteristic.

[Figure 4](#) shows the typical waveforms for a PLL with a f_0 locked phase comparator 1.

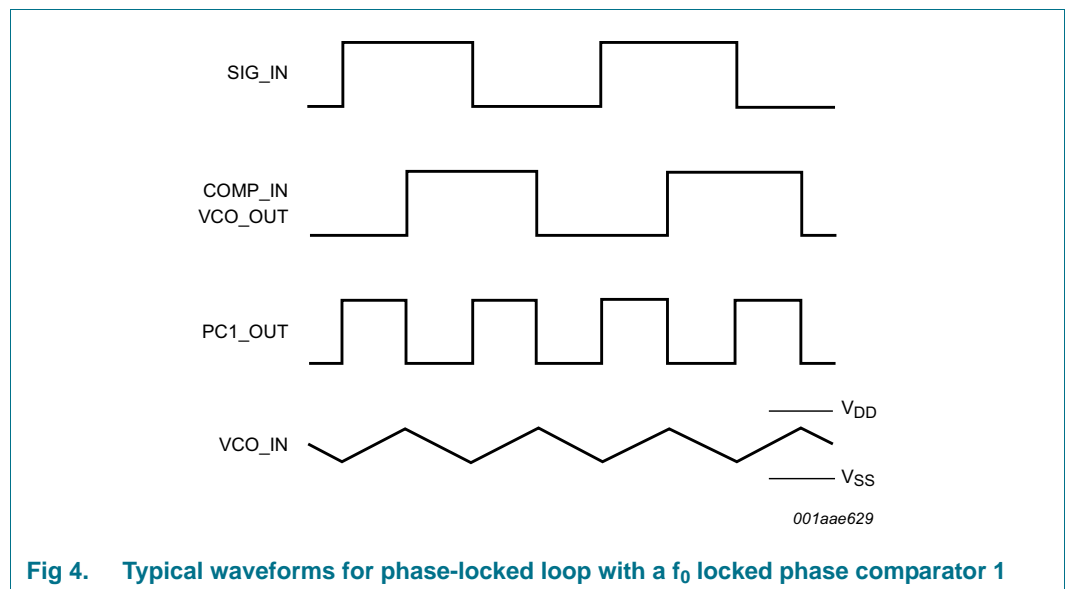
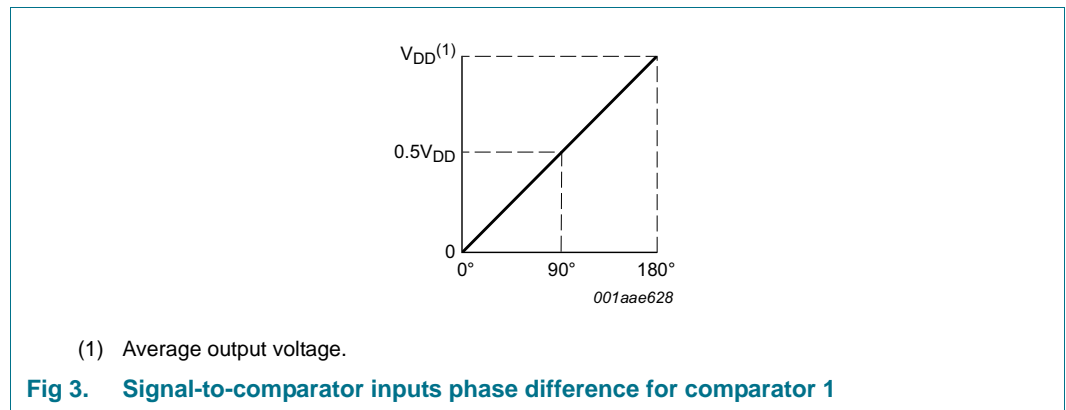

Phase comparator 2 is an edge-controlled digital memory network. It consists of four flip-flops, control gating and a 3-state output circuit comprising p and n-type drivers with a common output node. When the p-type or n-type drivers are ON, they pull the output up to V_{DD} or down to V_{SS} respectively. This type of phase comparator only acts on the positive-going edges of the signals at SIG_IN and COMP_IN. Therefore, the duty factors of these signals are not of importance.

If the signal input frequency is higher than the comparator input frequency, the p-type output driver is maintained ON most of the time, and both the n and p-type drivers are OFF (3-state) the remainder of the time. If the signal input frequency is lower than the comparator input frequency, the n-type output driver is maintained ON most of the time, and both the n and p-type drivers are OFF the remainder of the time. If the signal input and comparator input frequencies are equal, but the signal input lags the comparator input in phase, the n-type output driver is maintained ON for a time corresponding to the phase difference. If the comparator input lags the signal input in phase, the p-type output driver is maintained ON for a time corresponding to the phase difference. Subsequently, the voltage at the capacitor of the low-pass filter connected to this phase comparator is adjusted until the signal and comparator inputs are equal in both phase and frequency. At this stable point, both p and n-type drivers remain OFF and thus the phase comparator output becomes an open circuit and keeps the voltage at the capacitor of the low-pass filter constant.

Moreover, the signal at the phase comparator pulse output (PCP_OUT) is a HIGH level, which can be used for indicating a locked condition. Thus, for phase comparator 2, no phase difference exists between the signal and comparator inputs over the full VCO frequency range. Moreover, the power dissipation due to the low-pass filter is reduced when this type of phase comparator is used, because both p and n-type output drivers are OFF for most of the signal input cycle. It should be noted that the PLL lock range for this type of phase comparator is equal to the capture range, independent of the low-pass filter. With no signal present at the signal input, the VCO is adjusted to its lowest frequency for phase comparator 2. [Figure 5](#) shows typical waveforms for a PLL employing this type of locked phase comparator.

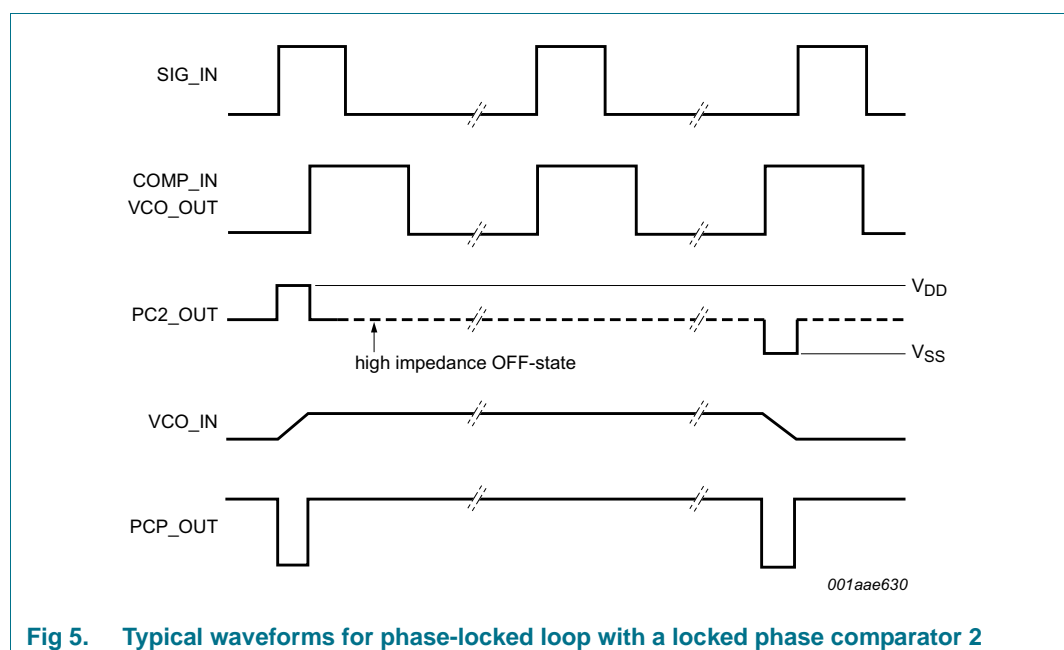

Fig 5. Typical waveforms for phase-locked loop with a locked phase comparator 2

Figure 6 shows the state diagram for phase comparator 2. Each circle represents a state of the comparator. The number at the top, inside each circle, represents the state of the comparator, while the logic state of the signal and comparator inputs are represented by a '0' for a logic LOW or a '1' for a logic HIGH, and they are shown in the left and right bottom of each circle.

The transitions from one to another result from either a logic change at the signal input (S representing SIG_IN) or the comparator input (C representing COMP_IN). A positive-going and a negative-going transition are shown by an arrow pointing up or down respectively.

The state diagram assumes, that only one transition on either the signal input or comparator input occurs at any instant.

- States 3, 5, 9 and 11 represent the output condition when the p-type driver is ON.
- States 2, 4, 10 and 12 determine the condition when the n-type driver is ON.
- States 1, 6, 7 and 8 represent the condition when the output is in its high-impedance OFF state; i.e. both p and n-type drivers are OFF, and the PCP_OUT output is HIGH. The condition at output PCP_OUT for all other states is LOW.

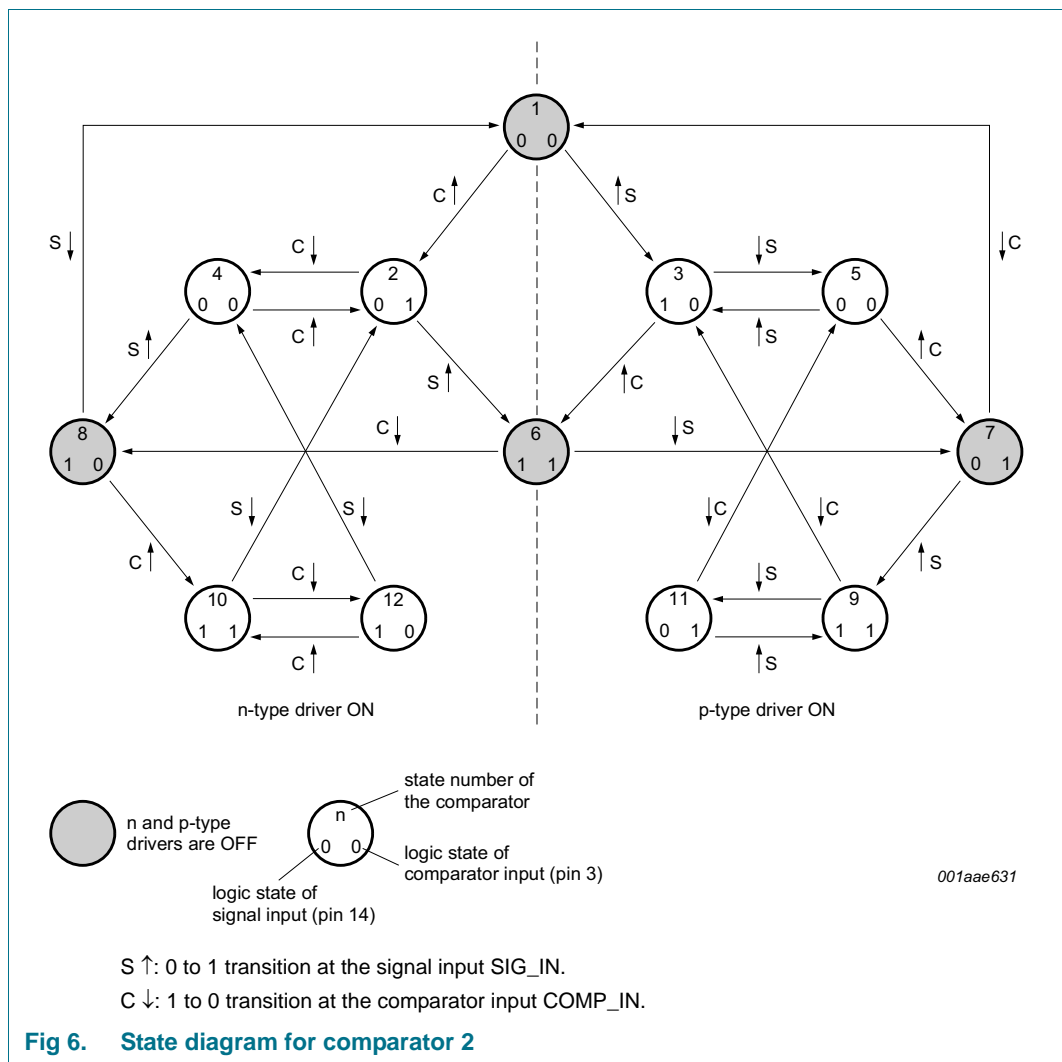

Fig 6. State diagram for comparator 2

7. Limiting values

Table 3. Limiting values

In accordance with the Absolute Maximum Rating System (IEC 60134).

Symbol	Parameter	Conditions	Min	Max	Unit
V_{DD}	supply voltage		-0.5	+18	V
I_{IK}	input clamping current	$V_I < -0.5\text{ V}$ or $V_I > V_{DD} + 0.5\text{ V}$	-	± 10	mA
V_I	input voltage		-0.5	$V_{DD} + 0.5$	V
I_{OK}	output clamping current	$V_O < -0.5\text{ V}$ or $V_O > V_{DD} + 0.5\text{ V}$	-	± 10	mA
$I_{I/O}$	input/output current		-	± 10	mA
I_{DD}	supply current		-	50	mA
T_{stg}	storage temperature		-65	+150	°C
T_{amb}	ambient temperature		-40	+85	°C
P_{tot}	total power dissipation	SO16 package [1]	-	500	mW
P	power dissipation	per output	-	100	mW

[1] For SO16 package: P_{tot} derates linearly with 8 mW/K above 70 °C.

8. Recommended operating conditions

Table 4. Recommended operating conditions

Symbol	Parameter	Conditions	Min	Typ	Max	Unit
V_{DD}	supply voltage		3	-	15	V
		as fixed oscillator only	3	-	15	V
		phase-locked loop operation	5	-	15	V
V_I	input voltage		0	-	V_{DD}	V
T_{amb}	ambient temperature	in free air	-40	-	+85	°C
$\Delta t/\Delta V$	input transition rise and fall rate	for INH input				
		$V_{DD} = 5\text{ V}$	-	-	3.75	$\mu\text{s/V}$
		$V_{DD} = 10\text{ V}$	-	-	0.5	$\mu\text{s/V}$
		$V_{DD} = 15\text{ V}$	-	-	0.08	$\mu\text{s/V}$

9. Static characteristics

Table 5. Static characteristics
 $V_{SS} = 0\text{ V}$; $V_I = V_{SS}$ or V_{DD} unless otherwise specified.

Symbol	Parameter	Conditions	V_{DD}	$T_{amb} = -40\text{ }^{\circ}\text{C}$		$T_{amb} = 25\text{ }^{\circ}\text{C}$		$T_{amb} = 85\text{ }^{\circ}\text{C}$		Unit
				Min	Max	Min	Max	Min	Max	
V_{IH}	HIGH-level input voltage	$ I_O < 1\text{ }\mu\text{A}$	5 V	3.5	-	3.5	-	3.5	-	V
			10 V	7.0	-	7.0	-	7.0	-	V
			15 V	11.0	-	11.0	-	11.0	-	V
V_{IL}	LOW-level input voltage	$ I_O < 1\text{ }\mu\text{A}$	5 V	-	1.5	-	1.5	-	1.5	V
			10 V	-	3.0	-	3.0	-	3.0	V
			15 V	-	4.0	-	4.0	-	4.0	V
V_{OH}	HIGH-level output voltage	$ I_O < 1\text{ }\mu\text{A}$	5 V	4.95	-	4.95	-	4.95	-	V
			10 V	9.95	-	9.95	-	9.95	-	V
			15 V	14.95	-	14.95	-	14.95	-	V
V_{OL}	LOW-level output voltage	$ I_O < 1\text{ }\mu\text{A}$	5 V	-	0.05	-	0.05	-	0.05	V
			10 V	-	0.05	-	0.05	-	0.05	V
			15 V	-	0.05	-	0.05	-	0.05	V
I_{OH}	HIGH-level output current	$V_O = 2.5\text{ V}$	5 V	-	-1.7	-	-1.4	-	-1.1	mA
		$V_O = 4.6\text{ V}$	5 V	-	-0.52	-	-0.44	-	-0.36	mA
		$V_O = 9.5\text{ V}$	10 V	-	-1.3	-	-1.1	-	-0.9	mA
		$V_O = 13.5\text{ V}$	15 V	-	-3.6	-	-3.0	-	-2.4	mA
I_{OL}	LOW-level output current	$V_O = 0.4\text{ V}$	5 V	0.52	-	0.44	-	0.36	-	mA
		$V_O = 0.5\text{ V}$	10 V	1.3	-	1.1	-	0.9	-	mA
		$V_O = 1.5\text{ V}$	15 V	3.6	-	3.0	-	2.4	-	mA
I_I	input leakage current		15 V	-	± 0.3	-	± 0.3	-	± 1.0	μA
I_{OZ}	OFF-state output current	output HIGH and returned to V_{DD}	15 V	-	1.6	-	1.6	-	12.0	μA
		output LOW and returned to V_{SS}	15 V	-	1.6	-	1.6	-	12.0	μA
I_{DD}	supply current	$I_O = 0\text{ A}$	5 V [1]	-	-	20	-	-	-	μA
			10 V [1]	-	-	300	-	-	-	μA
			15 V [1]	-	-	750	-	-	-	μA
			5 V [2]	-	20	-	20	-	150	μA
			10 V [2]	-	40	-	40	-	300	μA
			15 V [2]	-	80	-	80	-	600	μA
C_I	input capacitance	for INH input		-	-	-	7.5	-	-	pF

[1] Pin 15 open; pin 5 at V_{DD} ; pins 3 and 9 at V_{SS} ; pin 14 open.

[2] Pin 15 open; pin 5 at V_{DD} ; pins 3 and 9 at V_{SS} ; pin 14 at V_{DD} ; input current pin 14 not included.

10. Dynamic characteristics

Table 6. Dynamic characteristics
 $V_{SS} = 0\text{ V}$; $T_{amb} = 25\text{ °C}$; $C_L = 50\text{ pF}$; input transition times $\leq 20\text{ ns}$.

Symbol	Parameter	Conditions	V _{DD}	Min	Typ	Max	Unit
Phase comparators							
R _I	input resistance	SIG_IN input; at self-bias operating point	5 V	-	750	-	kΩ
			10 V	-	220	-	kΩ
			15 V	-	140	-	kΩ
V _{i(sens)}	input voltage sensitivity	SIG_IN input A.C. coupled; peak-to-peak values; R1 = 10 kΩ; R2 = ∞; C1 = 100 pF; independent of the lock range	5 V	-	150	-	mV
			10 V	-	150	-	mV
			15 V	-	200	-	mV
V _{IL}	LOW-level input voltage	SIG_IN and COMP_IN inputs, DC coupled LOW; full temperature range	5 V	-	-	1.5	V
			10 V	-	-	3.0	V
			15 V	-	-	4.0	V
V _{IH}	HIGH-level input voltage	SIG_IN and COMP_IN inputs, D.C. coupled HIGH; full temperature range	5 V	3.5	-	-	V
			10 V	7.0	-	-	V
			15 V	11.0	-	-	V
I _{IH}	HIGH-level input current	SIG_IN input; at V _{DD}	5 V	-	7	-	μA
			10 V	-	30	-	μA
			15 V	-	70	-	μA
I _{IL}	LOW-level input current	SIG_IN input; at V _{SS}	5 V	-	-3	-	μA
			10 V	-	-18	-	μA
			15 V	-	-45	-	μA
VCO							
P	power dissipation	f ₀ = 10 kHz; R1 = 1 MΩ; R2 = ∞; VCO_IN at 0.5 V _{DD} ; see Figure 10 to 12	5 V	-	150	-	μW
			10 V	-	2500	-	μW
			15 V	-	9000	-	μW
f _{max}	maximum frequency	VCO_IN at V _{DD} ; R1 = 10 kΩ; R2 = ∞; C1 = 50 pF	5 V	0.5	1.0	-	MHz
			10 V	1.0	2.0	-	MHz
			15 V	1.3	2.7	-	MHz
Δf/ΔT	frequency variation with temperature	no frequency offset (f _{min} = 0 Hz)	5 V [1]	-	0.22 to 0.30	-	% Hz/°C
			10 V [1]	-	0.04 to 0.05	-	% Hz/°C
			15 V [1]	-	0.01 to 0.05	-	% Hz/°C
		with frequency offset (f _{min} > 0 Hz)	5 V [1]	-	0 to 0.22	-	% Hz/°C
			10 V [1]	-	0 to 0.04	-	% Hz/°C
			15 V [1]	-	0 to 0.01	-	% Hz/°C

Table 6. Dynamic characteristics ...continued

$V_{SS} = 0\text{ V}$; $T_{amb} = 25\text{ °C}$; $C_L = 50\text{ pF}$; input transition times $\leq 20\text{ ns}$.

Symbol	Parameter	Conditions	V _{DD}	Min	Typ	Max	Unit
$\Delta f/f$	relative frequency variation	for VCO see Figure 13 and 14					
		R ₁ > 10 k Ω	5 V	-	0.50	-	% Hz
		R ₁ > 400 k Ω	10 V	-	0.25	-	% Hz
		R ₁ = M Ω	15 V	-	0.25	-	% Hz
δ	duty factor	VCO_OUT output	5 V	-	50	-	%
			10 V	-	50	-	%
			15 V	-	50	-	%
R _{in}	input resistance	for pin VCO_IN			10		M Ω
Source follower							
V _{offset}	offset voltage	R _L = 10 k Ω ; VCO_IN at 0.5V _{DD}	5 V [2]	-	1.7	-	V
			10 V	-	2.0	-	V
			15 V	-	2.1	-	V
		R _L = 50 k Ω ; VCO_IN at 0.5V _{DD}	5 V	-	1.5	-	V
			10 V	-	1.7	-	V
			15 V	-	1.8	-	V
$\Delta f/f$	relative frequency variation	VCO output; R _L > 50 k Ω ; see Figure 13	5 V	-	0.3	-	%
			10 V	-	1.0	-	%
			15 V	-	1.3	-	%
Zener diode							
V _Z	working voltage	I _Z = 50 μ A	-	-	7.3	-	V
R _{dyn}	dynamic resistance	For internal Zener diode; I _Z = 1 mA	-	-	25	-	Ω

[1] Over the recommended component range.

[2] The offset voltage is equal to the input voltage on pin VCO_IN minus the output voltage on pin SF_OUT.

11. Design information

Table 7. Design information

Test	Using phase comparator 1	Using phase comparator 2
VCO adjusts with no signal on SIG_IN	VCO in PLL system adjusts to center frequency (f ₀)	VCO in PLL system adjusts to minimum frequency (f _{min})
Phase angle between SIG_IN and COMP_IN	90° at center frequency (f ₀), approaching 0° and 180° at the ends of the lock range (2f _L)	always 0° in lock (positive-going edges)
Locks on harmonics of center frequency	yes	no
Signal input noise rejection	high	low
Lock frequency range (2f _L)	the frequency range of the input signal on which the loop will stay locked if it was initially in lock; 2f _L = full VCO frequency range = f _{max} - f _{min}	
Capture frequency range (2f _c)	the frequency range of the input signal on which the loop will lock if it was initially out of lock	
	depends on low-pass filter characteristics; 2f _c < 2f _L	2f _c = 2f _L
Center frequency (f ₀)	the frequency of the VCO when VCO_IN at 0.5V _{DD}	

11.1 VCO component selection

Recommended range for R1 and R2: 10 kΩ to 1 MΩ; for C1: 50 pF to any practical value.

1. VCO without frequency offset (R2 = ∞). 0
 - a. Given f₀: use f₀ with [Figure 7](#) to determine R1 and C1.
 - b. Given f_{max}: calculate f₀ from f₀ = 0.5f_{max}; use f₀ with [Figure 7](#) to determine R1 and C1.
2. VCO with frequency offset.
 - a. Given f₀ and 2f_L : calculate f_{min} from the equation f_{min} = f₀ - 2f_L; use f_{min} with [Figure 8](#) to determine R2 and C1; calculate $\frac{f_{max}}{f_{min}}$ from the equation

$$\frac{f_{max}}{f_{min}} = \frac{f_0 + 2f_L}{f_0 - 2f_L};$$
 use $\frac{f_{max}}{f_{min}}$ with [Figure 9](#) to determine the ratio R2/R1 to obtain R1.
 - b. Given f_{min} and f_{max}: use f_{min} with [Figure 8](#) to determine R2 and C1; calculate $\frac{f_{max}}{f_{min}}$; use $\frac{f_{max}}{f_{min}}$ with [Figure 9](#) to determine R2/R1 to obtain R1.

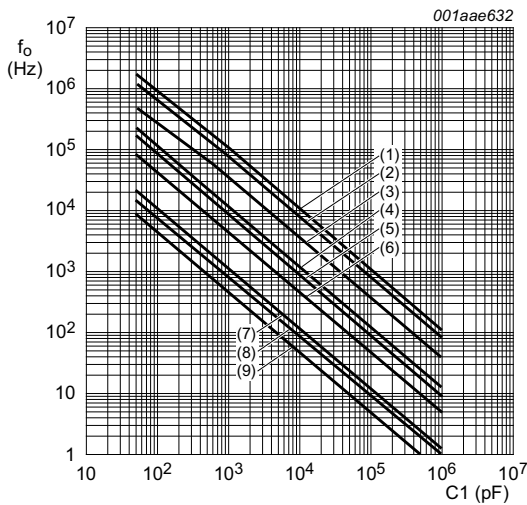

T_{amb} = 25 °C; VCO_IN at 0.5V_{DD}; INH_IN at V_{SS}; R2 = ∞.
 Lines (1), (4), and (7): V_{DD} = 15 V;
 Lines (2), (5), and (8): V_{DD} = 10 V;
 Lines (3), (6), and (9): V_{DD} = 5 V;
 Lines (1), (2), and (3): R1 = 10 kΩ;
 Lines (4), (5), and (6): R1 = 100 kΩ;
 Lines (7), (8), and (9): R1 = 1 MΩ.

Fig 7. Typical center frequency as a function of capacitor C1

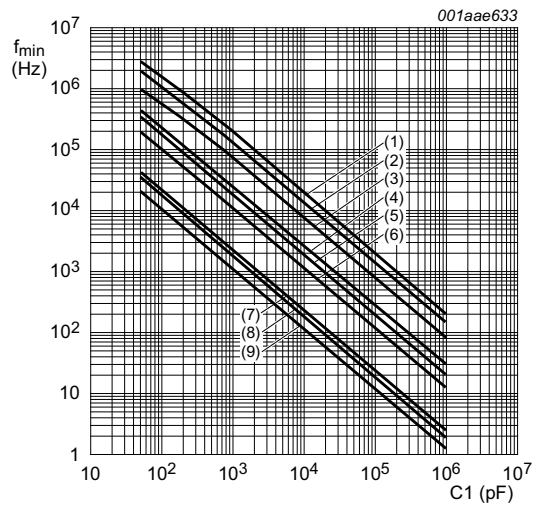

T_{amb} = 25 °C; VCO_IN at V_{SS}; INH_IN at V_{SS}; R1 = ∞.
 Lines (1), (4), and (7): V_{DD} = 15 V;
 Lines (2), (5), and (8): V_{DD} = 10 V;
 Lines (3), (6), and (9): V_{DD} = 5 V;
 Lines (1), (2), and (3): R2 = 10 kΩ;
 Lines (4), (5), and (6): R2 = 100 kΩ;
 Lines (7), (8), and (9): R2 = 1 MΩ.

Fig 8. Typical frequency offset as a function of capacitor C1

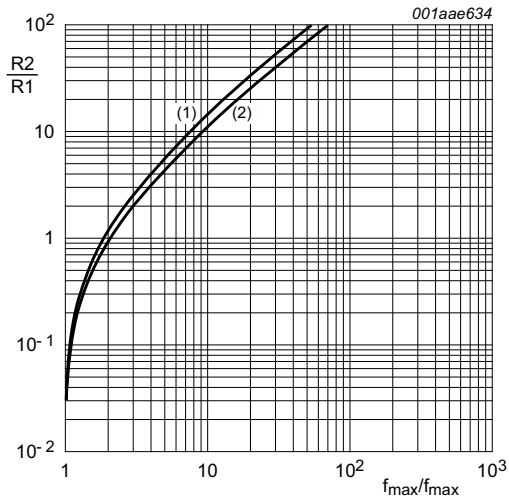

Line (1): $V_{DD} = 5\text{ V}$;
Line (2): $V_{DD} = 10\text{ V}, 15\text{ V}$.

Fig 9. Typical ratio of $R2/R1$ as a function of the ratio f_{max}/f_{min}

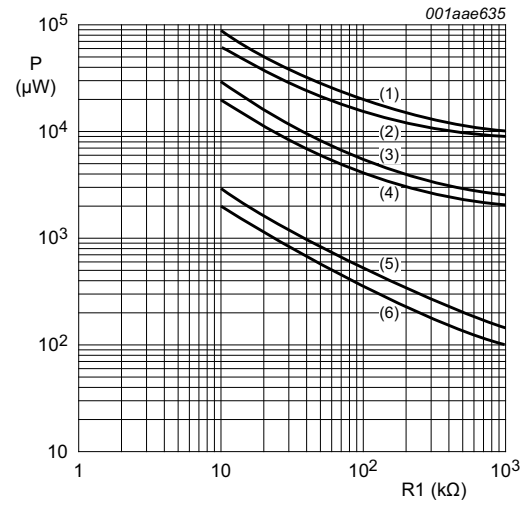

$R2 = \infty$; VCO_IN at $0.5V_{DD}$; $C_L = 50\text{ pF}$.
Lines (1) and (2): $V_{DD} = 15\text{ V}$;
Lines (3) and (4): $V_{DD} = 10\text{ V}$;
Lines (5) and (6): $V_{DD} = 5\text{ V}$;
Lines (1), (3), and (5): $C1 = 50\text{ pF}$;
Lines (2), (4), and (6): $C1 = 1\text{ }\mu\text{F}$.

Fig 10. Power dissipation as a function of $R1$

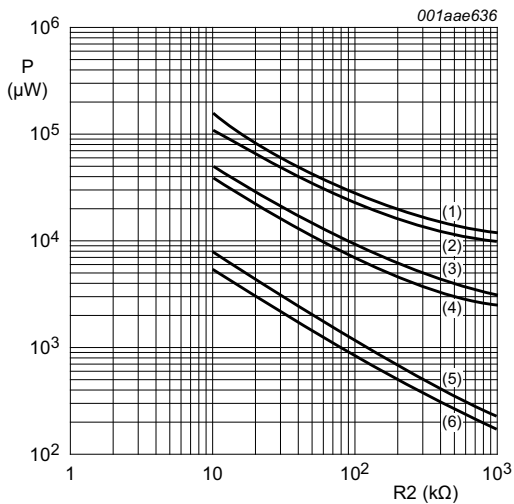

$R1 = \infty$; VCO_IN at $V_{SS} (0\text{ V})$; $C_L = 50\text{ pF}$.
Lines (1) and (2): $V_{DD} = 15\text{ V}$;
Lines (3) and (4): $V_{DD} = 10\text{ V}$;
Lines (5) and (6): $V_{DD} = 5\text{ V}$;
Lines (1), (3), and (5): $C1 = 50\text{ pF}$;
Lines (2), (4), and (6): $C1 = 1\text{ }\mu\text{F}$.

Fig 11. Power dissipation as a function of $R2$

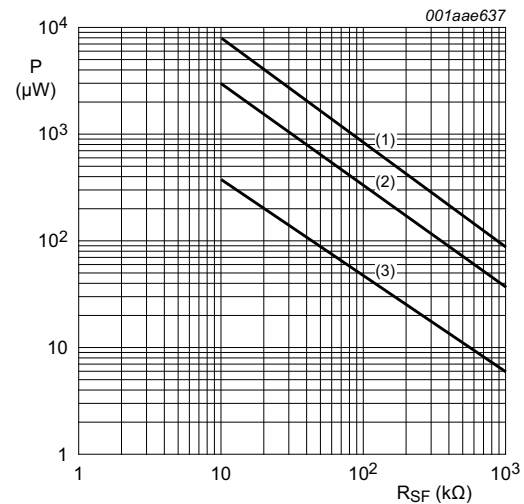

VCO_IN at $0.5V_{DD}$; $R1 = \infty$; $R2 = \infty$.
Line (1): $V_{DD} = 15\text{ V}$;
Line (2): $V_{DD} = 10\text{ V}$;
Line (3): $V_{DD} = 5\text{ V}$.

Fig 12. Power dissipation of source follower as a function of R_L

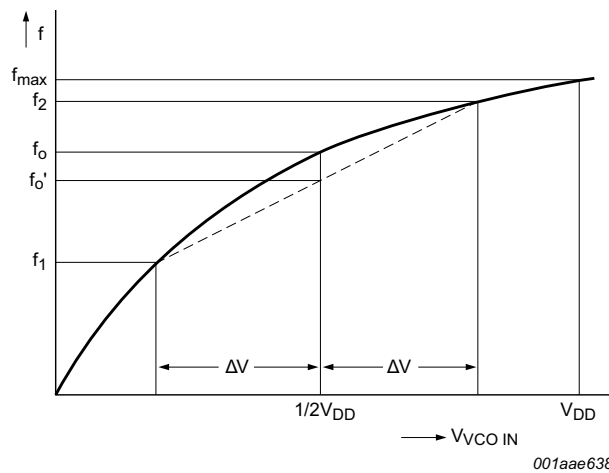

See [Section 10](#).

For VCO linearity:

$$f_0 = \frac{f_1 + f_2}{2}$$

$$linearity = \frac{f_0' - f_0}{f_0} \times 100 \%$$

This figure and the above formula also apply to source follower linearity: substitute V_O at SF_OUT for f .

$\Delta V = 0.3 \text{ V}$ at $V_{DD} = 5 \text{ V}$;

$\Delta V = 2.5 \text{ V}$ at $V_{DD} = 10 \text{ V}$;

$\Delta V = 5.0 \text{ V}$ at $V_{DD} = 15 \text{ V}$.

Fig 13. Definition of linearity

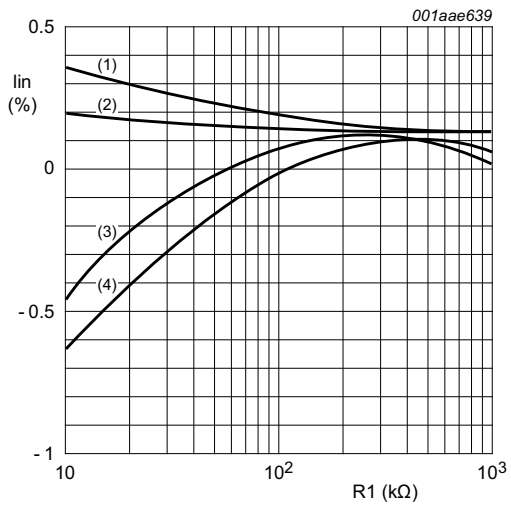

a. $V_{DD} = 5\text{ V}$

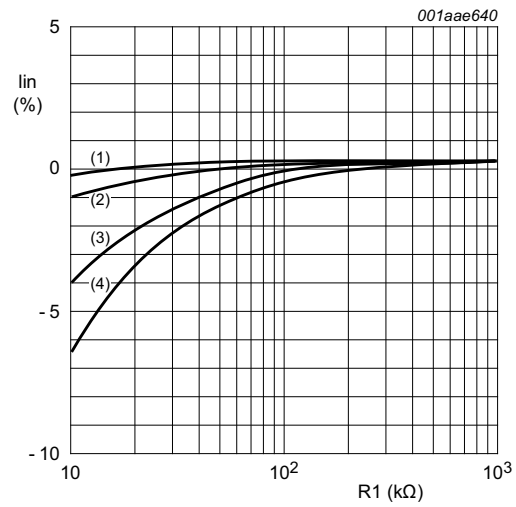

b. $V_{DD} = 10\text{ V}$

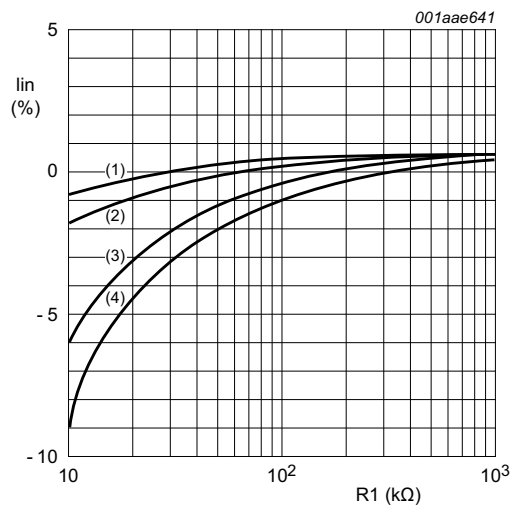

c. $V_{DD} = 15\text{ V}$

$R_2 = \infty$;

Line (1): $C_1 = 1\ \mu\text{F}$;

Line (2): $C_1 = 1\ \text{nF}$;

Line (3): $C_1 = 100\ \text{pF}$;

Line (4): $C_1 = 50\ \text{pF}$.

Fig 14. VCO frequency linearity as a function of R1

12. Package outline

SO16: plastic small outline package; 16 leads; body width 3.9 mm

SOT109-1

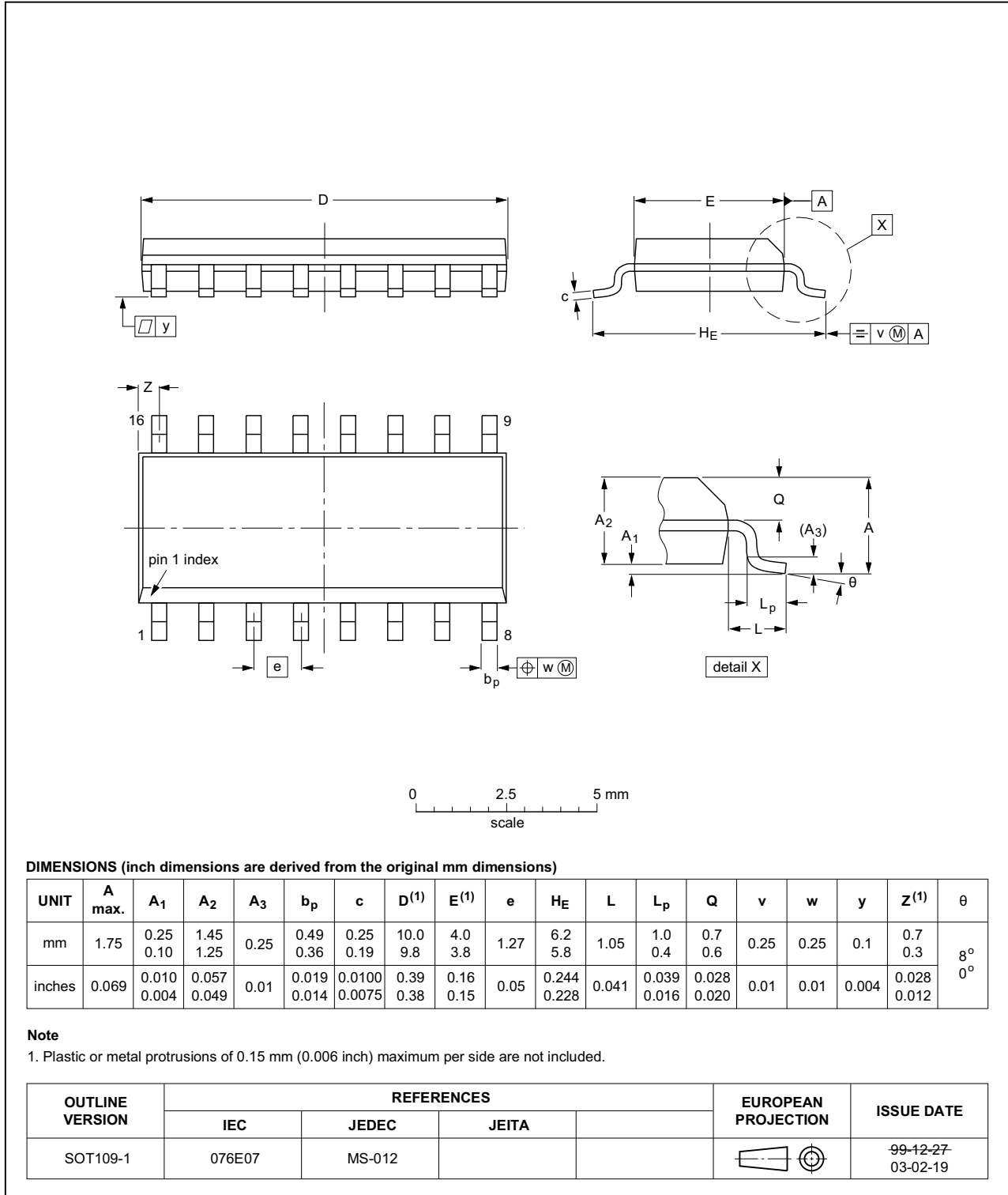

Fig 15. Package outline SOT109-1 (SO16)

13. Revision history

Table 8. Revision history

Document ID	Release date	Data sheet status	Change notice	Supersedes
HEF4046B v.6	20160324	Product data sheet	-	HEF4046B v.5
Modifications:	<ul style="list-style-type: none"> Type number HEF4046BP (SOT38-4) removed. 			
HEF4046B v.5	20111118	Product data sheet	-	HEF4046B v.4
Modifications:	<ul style="list-style-type: none"> Section Applications removed Table 5: I_{OH} minimum values changed to maximum Table 6: R_{in} typical value changed from 10⁶ MΩ to 10 MΩ 			
HEF4046B v.4	20100105	Product data sheet	-	HEF4046B_CNV v.3
HEF4046B_CNV v.3	19950101	Product specification	-	HEF4046B_CNV v.2
HEF4046B_CNV v.2	19950101	Product specification	-	-

14. Legal information

14.1 Data sheet status

Document status ^{[1][2]}	Product status ^[3]	Definition
Objective [short] data sheet	Development	This document contains data from the objective specification for product development.
Preliminary [short] data sheet	Qualification	This document contains data from the preliminary specification.
Product [short] data sheet	Production	This document contains the product specification.

[1] Please consult the most recently issued document before initiating or completing a design.

[2] The term 'short data sheet' is explained in section "Definitions".

[3] The product status of device(s) described in this document may have changed since this document was published and may differ in case of multiple devices. The latest product status information is available on the Internet at URL <http://www.nexperia.com>.

14.2 Definitions

Draft — The document is a draft version only. The content is still under internal review and subject to formal approval, which may result in modifications or additions. Nexperia does not give any representations or warranties as to the accuracy or completeness of information included herein and shall have no liability for the consequences of use of such information.

Short data sheet — A short data sheet is an extract from a full data sheet with the same product type number(s) and title. A short data sheet is intended for quick reference only and should not be relied upon to contain detailed and full information. For detailed and full information see the relevant full data sheet, which is available on request via the local Nexperia sales office. In case of any inconsistency or conflict with the short data sheet, the full data sheet shall prevail.

Product specification — The information and data provided in a Product data sheet shall define the specification of the product as agreed between Nexperia and its customer, unless Nexperia and customer have explicitly agreed otherwise in writing. In no event however, shall an agreement be valid in which the Nexperia product is deemed to offer functions and qualities beyond those described in the Product data sheet.

14.3 Disclaimers

Limited warranty and liability — Information in this document is believed to be accurate and reliable. However, Nexperia does not give any representations or warranties, expressed or implied, as to the accuracy or completeness of such information and shall have no liability for the consequences of use of such information. Nexperia takes no responsibility for the content in this document if provided by an information source outside of Nexperia.

In no event shall Nexperia be liable for any indirect, incidental, punitive, special or consequential damages (including - without limitation - lost profits, lost savings, business interruption, costs related to the removal or replacement of any products or rework charges) whether or not such damages are based on tort (including negligence), warranty, breach of contract or any other legal theory.

Notwithstanding any damages that customer might incur for any reason whatsoever, Nexperia's aggregate and cumulative liability towards customer for the products described herein shall be limited in accordance with the *Terms and conditions of commercial sale* of Nexperia.

Right to make changes — Nexperia reserves the right to make changes to information published in this document, including without limitation specifications and product descriptions, at any time and without notice. This document supersedes and replaces all information supplied prior to the publication hereof.

Suitability for use — Nexperia products are not designed, authorized or warranted to be suitable for use in life support, life-critical or safety-critical systems or equipment, nor in applications where failure or malfunction of a Nexperia product can reasonably be expected to result in personal injury, death or severe property or environmental damage. Nexperia and its suppliers accept no liability for inclusion and/or use of Nexperia products in such equipment or applications and therefore such inclusion and/or use is at the customer's own risk.

Applications — Applications that are described herein for any of these products are for illustrative purposes only. Nexperia makes no representation or warranty that such applications will be suitable for the specified use without further testing or modification.

Customers are responsible for the design and operation of their applications and products using Nexperia products, and Nexperia accepts no liability for any assistance with applications or customer product design. It is customer's sole responsibility to determine whether the Nexperia product is suitable and fit for the customer's applications and products planned, as well as for the planned application and use of customer's third party customer(s). Customers should provide appropriate design and operating safeguards to minimize the risks associated with their applications and products.

Nexperia does not accept any liability related to any default, damage, costs or problem which is based on any weakness or default in the customer's applications or products, or the application or use by customer's third party customer(s). Customer is responsible for doing all necessary testing for the customer's applications and products using Nexperia products in order to avoid a default of the applications and the products or of the application or use by customer's third party customer(s). Nexperia does not accept any liability in this respect.

Limiting values — Stress above one or more limiting values (as defined in the Absolute Maximum Ratings System of IEC 60134) will cause permanent damage to the device. Limiting values are stress ratings only and (proper) operation of the device at these or any other conditions above those given in the Recommended operating conditions section (if present) or the Characteristics sections of this document is not warranted. Constant or repeated exposure to limiting values will permanently and irreversibly affect the quality and reliability of the device.

Terms and conditions of commercial sale — Nexperia products are sold subject to the general terms and conditions of commercial sale, as published at <http://www.nexperia.com/profile/terms>, unless otherwise agreed in a valid written individual agreement. In case an individual agreement is concluded only the terms and conditions of the respective agreement shall apply. Nexperia hereby expressly objects to applying the customer's general terms and conditions with regard to the purchase of Nexperia products by customer.

No offer to sell or license — Nothing in this document may be interpreted or construed as an offer to sell products that is open for acceptance or the grant, conveyance or implication of any license under any copyrights, patents or other industrial or intellectual property rights.

Export control — This document as well as the item(s) described herein may be subject to export control regulations. Export might require a prior authorization from competent authorities.

Non-automotive qualified products — Unless this data sheet expressly states that this specific Nexperia product is automotive qualified, the product is not suitable for automotive use. It is neither qualified nor tested in accordance with automotive testing or application requirements. Nexperia accepts no liability for inclusion and/or use of non-automotive qualified products in automotive equipment or applications.

In the event that customer uses the product for design-in and use in automotive applications to automotive specifications and standards, customer (a) shall use the product without Nexperia's warranty of the product for such automotive applications, use and specifications, and (b) whenever customer uses the product for automotive applications beyond

Nexperia's specifications such use shall be solely at customer's own risk, and (c) customer fully indemnifies Nexperia for any liability, damages or failed product claims resulting from customer design and use of the product for automotive applications beyond Nexperia's standard warranty and Nexperia's product specifications.

Translations — A non-English (translated) version of a document is for reference only. The English version shall prevail in case of any discrepancy between the translated and English versions.

14.4 Trademarks

Notice: All referenced brands, product names, service names and trademarks are the property of their respective owners.

15. Contact information

For more information, please visit: <http://www.nexperia.com>

For sales office addresses, please send an email to: salesaddresses@nexperia.com

16. Contents

1	General description	1
2	Features and benefits	1
3	Ordering information	1
4	Functional diagram	2
5	Pinning information	2
5.1	Pinning	2
5.2	Pin description	3
6	Functional description	3
6.1	VCO control	3
6.2	Phase comparators	3
7	Limiting values	7
8	Recommended operating conditions	7
9	Static characteristics	8
10	Dynamic characteristics	9
11	Design information	10
11.1	VCO component selection	11
12	Package outline	15
13	Revision history	16
14	Legal information	17
14.1	Data sheet status	17
14.2	Definitions	17
14.3	Disclaimers	17
14.4	Trademarks	18
15	Contact information	18
16	Contents	19

单击下面可查看定价，库存，交付和生命周期等信息

[>>Nexperia\(安世\)](#)